

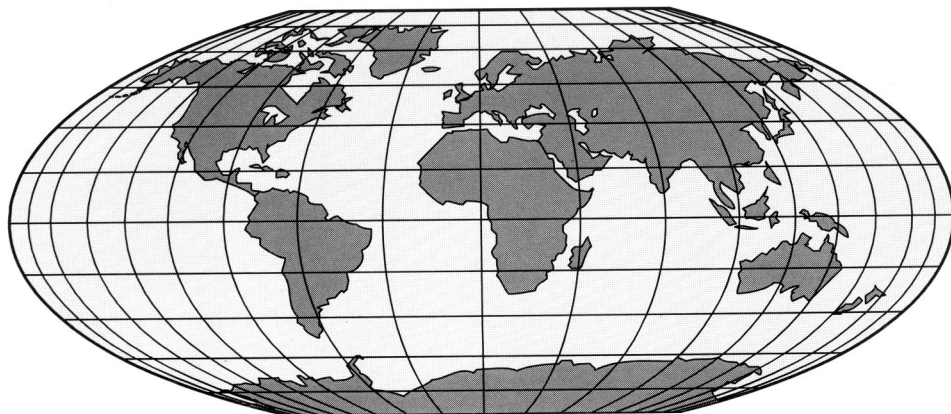

Edition 2001





**GIUNTI OMOCINETICI
E SEMIASSI**

**CONSTANT VELOCITY JOINTS
AND COMPLETE SHAFTS**

**RADGELENKE UND
ANTRIEBSWELLEN**

**JOINTS HOMOCINÉTIQUES
ET TRANSMISSIONS**

**JUNTA HOMOCINETICA
Y EJES COMPLETOS**

**ШАРНИРЫ РАВНЫХ УГЛОВЫХ
СКОРОСТЕЙ
И ПОЛУПРИВОДЫ В КОМПЛЕКТЕ**

 **GLO[®]**





CERTIFICATE OF APPROVAL

This is to certify that the Quality Management System of:

Glo S.p.A
Poggio Rusco, Mantova
Italy

*has been approved by Lloyd's Register Quality Assurance
to the following Quality Management System Standards:*

ISO 9001:1994
EN ISO 9001:1994
UNI EN ISO 9001:1994

The Quality Management System is applicable to:

***Design and manufacture of constant velocity joints and
complete shafts. Manufacture of precision machined
parts for the automotive and mechanical industry.***

Approval
Certificate No: LRC 160053

Original Approval: 17th July 1996

Current Certificate: 13th December 1999

Certificate Expiry: 30th June 2002

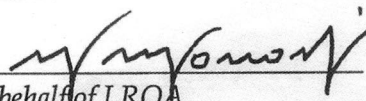
on behalf of LRQA



001

This approval is carried out in accordance with the LRQA assessment and certification procedures and monitored by LRQA.
The use of the UKAS Accreditation Mark indicates Accreditation in respect of those activities covered by the Accreditation Certificate Number 001
Macro rev 4.0

LLOYD'S REGISTER QUALITY ASSURANCE

INDICE TABLE OF CONTENTS INHALTSVERZEICHNIS INDEX INDICE СОДЕРЖАНИЕ

Vedi pagina - See page
Siehe Seite - Voir page
Ver pagina - см. страница

COME LEGGERE IL CATALOGO HOW TO READ THIS CATALOGUE LESEHILFE ZUM KATALOG INSTRUCTIONS POUR LA CONSULTATION DU CATALOGUE INSTRUCCIONES PARA LEER EL CATALOGO КАК ПОЛЬЗОВАТЬСЯ КАТАЛОГОМ	6
--	---

SIMBOLOGIA ED ABBREVIAZIONI SYMBOLS AND ABBREVIATIONS SYMBOLE UND ABKÜRZUNGEN SYMBOLOGIE ET ABBREVIATIONS SIMBOLOGIA Y ABBREVIACIONES СИМВОЛЫ И СОКРАЩЕНИЯ	8
---	---

INDICE MARCHE AUTOVETTURE INDEX CAR APPLICATIONS FAHRZEUGTYPENLISTE INDEX APPLICATIONS LISTA DE APLICACIONES СПИСОК МАРОК АВТОМОБИЛЕЙ	10
--	----

LISTA RIFERIMENTI ED ALTRE CARATTERISTICHE PART NUMBERS LISTING AND OTHER CHARACTERISTICS REFERENZLISTE LISTE DE REFERENCES ET AUTRES CARACTERISTIQUES LISTA DE REFERENCIAS СПИСОК УКАЗАТЕЛЕЙ	11
--	----

LISTA DI CONVERSIONE OEM→GLO CROSS REFERENCE LIST OEM→GLO UMSCHLUESSELUNG OEM→GLO LISTE DE CORRESPONDANCE OEM→GLO LISTA DE CONVERSION OEM→GLO СПИСОК СООТВЕТСТВИЙ МЕЖДУ OEM ГЛО	21
--	----

NOVITA' NEL CATALOGO 2001 NEW ENTRIES IN 2001 CATALOGUE NEUHEITEN IM KATALOG 2001 NOUVEAUTES DANS LE CATALOGUE 2001 NOVITAS NEL CATALOGO 2001 НОВОЕ В КАТАЛОГЕ 2001	34
--	----

TESTO GIUNTI C. V. JOINTS GELENKE JOINTS JUNTAS ШРУС	41
---	----

TESTO SEMIASSI SHAFTS ANTRIEBSWELLEN TRANSMISSIONS SEMIEJES ПОЛУПРИВОДЫ	157
--	-----

CONDIZIONI GENERALI GENERAL CONDITIONS ALLGEMEINE HINWEISE CONDITIONS GENERALES CONDICIONES GENERALES ОСНОВНЫЕ ПОЛОЖЕНИЯ	160
---	-----

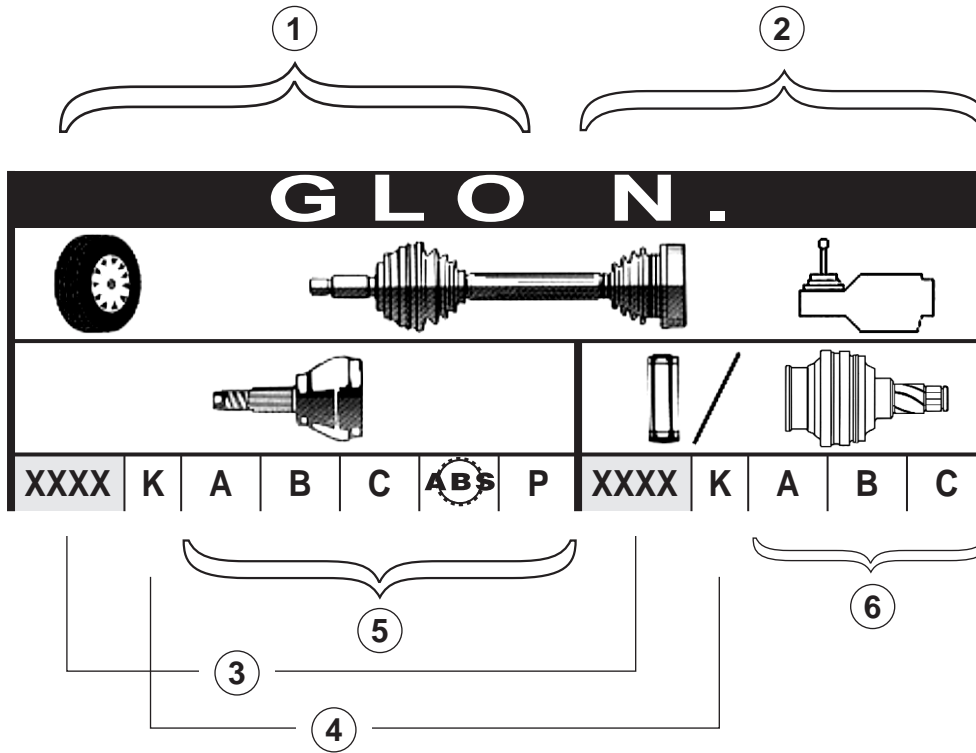

- ① Giunto lato ruota - Outer constant velocity joint - Radseitiges Aussengelenk - Joint exterieur cote roue
Junta externa lado rueda.
- ② Giunto lato cambio - Inner shifting joint - Schaltgetriebeseitiges Innengelenk - Joint interieur cote boite de vitesses
Junta interna lado cambio
- ③ (XXXX) Codice GLO - GLO part number - GLO Referenz - no. GLO - Codice GLO
- ④ (K) Disponibile con kit - available with kit - verfuegbar mit Satz - disponible avec le kit - disponible con kit

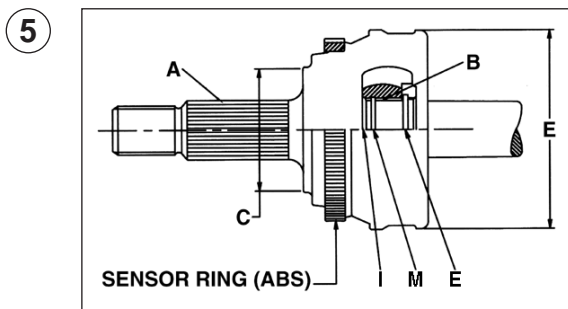

- (A) Numero denti esterni - number of teeth outer spline
Anzahl Aussenzaehne - n. dents exterieures
n. de dientes externos
- (B) Numero denti interni - number of teeth inner spline
Anzahl Innerzaehne - dents interieures
n. de dientes internos
- (C (mm)) Diametro tenuta - seal diameter - Durchmesser - diametre
diametro
- (E (mm)) Diametro esterno - outside diameter - äusserer Durchmesser
diametre exterieur - diametro esterno
(→ vedi tabella riferimenti - see references listings)
- (ABS) Numero denti ruota fonica - number of teeth ABS ring
Zaehneanzahl ABS-Tonrad - n. dents roue a impulsion ABS
n. de dientes rueda ABS
- (P) Posizione canalino - groove position - Einstich-Position - po-
sition de la gorge - posicion de la radura

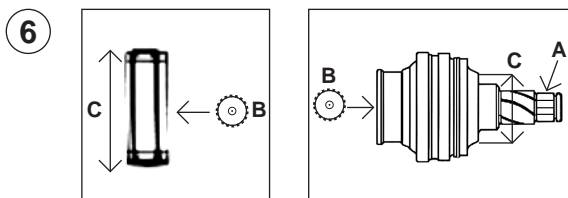

- (A) Numero denti esterni - number of teeth outer spline - Anzahl
Aussenzaehne - n. dents exterieures - n. de dientes externos
- (B) Numero denti interni - number of teeth inner spline - Anzahl
Innerzaehne - n. dents interieures - n. de dientes internos
- (C (mm)) Diametro tenuta - seal diameter - Durchmesser - diametre -
diametro

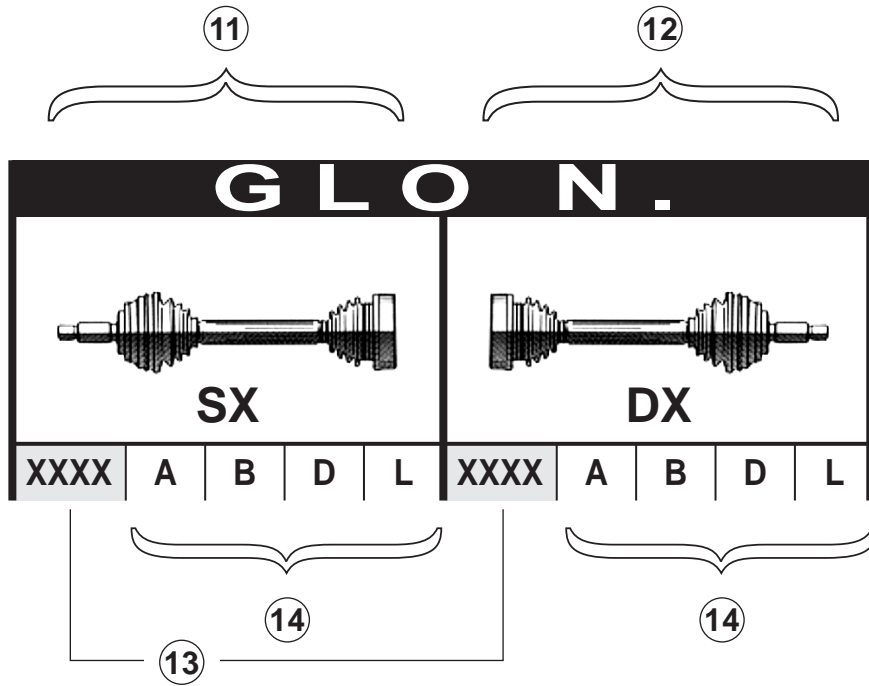

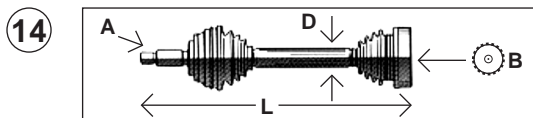

- ①① **(SX)** Semiasse sinistro - left complete shaft - Antriebswelle links - gauche transmission - izquierda semieje
- ①② **(DX)** Semiasse destro - right complete shaft - Antriebswelle rechts - droite transmission - derecho semieje
- ①③ **(XXXX)** Codice GLO - GLO part number - GLO Referenz - no. GLO - Codice GLO



- (A) Numero denti esterni - number of teeth outer spline - Anzahl Aussenzaehne - n. dents exterieures - n. de dientes externos
- (B) Numero denti interni - number of teeth inner spline - Anzahl Innerzaehne - n. dents interieures - n. de dientes internos
- (D (mm)) Diametro semiasse - diameter of shaft - Antriebswelle Durchmesser diametre transmission - diametro semieje
- (L (mm)) Lunghezza totale semiasse - total length - Gesamtlänge longueur totale - longitud total

	n. denti ruota fonica ABS	teeth of ABS ring	Zahneanzahl ABS-Tonrad	n. dents roue a impulsion ABS	n. de dientes rueda ABS
	descrizione veicolo	vehicle description	Fahrzeugbeschreibung	description véhicule	descripcion vehiculo
	anno costruzione veicolo	year vehicle construction	Baujahr	année construction véhicule	ano construccion vehiculo
	giunto lato ruota	outer constant velocity joint	Radseitiges Aussengelenk	joint extérieur coté roue	junta externa lado rueda
	semiassa	complete shaft	Antriebswelle	transmission	semieje
	giunto lato cambio	inner shifting joint	schaltgebiebeseitiges Innengelenk	joint intérieur coté boîte de vitesses	junta interna lado cambio
4WD	trazione integrale 4x4	four-wheel-drive	Vierradantrieb	traction quatre roues motrices	traccion integral
A	n. denti esterni	teeth of outer spline	Anzahl Aussenzaehne	n. dents exterieures	n. de dientes externos
A.T.	trasmissione automatica	automatic transmission	Automatikgetriebe	transmission automatique	transmision automatica
B	n. denti interni	teeth of inner spline	Anzahl Innenzaehne	n. dents interieures	n. de dientes internos
C (mm)	diametro tenuta	seal diameter	Durchmesser	diametre	diametro
CHASSIS NO.	n. telaio	chassis no	Fahrwerk Nr.	n. chassis	n. de chasis
CONV	convertibile, cabrio	convertible	Cabriolet	convertible, cabriolet	cabriole
CYL	cilindro/i	cylinder/s	Zylinder	cyindre	cilindro
DS	diesel	diesel	Diesel	diesel	diesel
DX	destro	right	rechts	droite	derecho
E (mm)	diametro esterno	outside diameter	äusserer Durchmesser	diametre extérieur	diametro esterno
FWD	trazione anteriore	front-wheel-drive	Vorderradantrieb	traction avant	traccion anterior
K	disponibile con KIT	available with KIT	verfuegbar mit Satz	disponible avec kit	disponible con kit
KIT	composto da: giunto + cuffia + dado + fascette lunga & corta + accessori	included: joint + boot + nut + long & short clamps + accessories	Inhalt: Gelenk + Manschette + Mutter + lange und kurze Laschen	Composé par: joint + soufflet + écrou + collier long + collier court	Compuesto par: junta + tuerca + guarda + abrazadera larga + abrazadera corta
LT	litri	liter	Liter	litres	litro

	Vedi pagina See page Siehe Seite Voir page Ver pagina см. страница
ACURA → HONDA	41
AIXAM	41
ALFA ROMEO	41
AMERICAN MOTORS	45
AUDI	45
AUTOBIANCHI	57
BELLIER	57
BLMC → ROVER	57
BRITISH LEYLAND → ROVER	57
BUICK (GENERAL MOTORS)	57
CADILLAC (GENERAL MOTORS)	59
CARLETTI	59
CASALINI	59
CHATENET	60
CHEVROLET (GENERAL MOTORS)	60
CHRYSLER	61
CITROËN	64
DAEWOO	66
DAIHATSU	67
DATSUN → NISSAN	67
DODGE (CHRYSLER)	68
EAGLE	72
FEAB	72
FERRARI	72
FIAT	72
FORD (AUSTRALIA)	81
FORD (BRAZIL)	81
FORD (EUROPE)	82
FORD (TAIWAN)	85
FORD (USA)	85
GEO	87
GMB (BRAZIL)	87
GMC	87
GRECAV	88
HOLDEN (AUSTRALIA)	88
HONDA	89
HYUNDAI	93
INNOCENTI	93
ISO	94
ISUZU	94
JDM	94
KIA	94
LADA	95
LAMBORGHINI	95
LANCIA	95
LEXUS	97
LIGIER	98
LINCOLN CONTINENTAL (FORD USA)	98

	Vedi pagina See page Siehe Seite Voir page Ver pagina см. страница
MASERATI	98
MAZDA	99
MERCEDES-BENZ	102
MERCURY (FORD USA)	103
MICROCAR	104
MITSUBISHI	104
MOSKVICH	108
NISSAN-DATSUN	109
OLDSMOBILE (GENERAL MOTORS)	113
OPEL (EUROPE)	114
PEUGEOT	118
PLYMOUTH (CHRYSLER)	121
PONTIAC (GENERAL MOTORS)	123
PORSCHE	125
PROTON (MITSUBISHI)	125
RENAULT	125
ROVER	127
SAAB	129
SAVEL-ERAD	131
SEAT	131
SECMA	133
SKODA	133
SUBARU	134
SUZUKI	136
TASSO	137
TOYOTA	137
VALENTINI	140
VAUXHALL	140
VOLKSWAGEN (BRAZIL)	143
VOLKSWAGEN	144
VOLVO	153
ZASTAVA	154
ZAZ	154

GLO N.	KIT	PCR	PR	A	B	C	ABS	E	P		
3006	K	P3	H	19	19	48		68	I	BLMC - BRITISH LEYLAND - ROVER	
3009	K	P3L	E	29	19	48		72	I	INNOCENTI - BLMC - BRITISH LEYLAND - ROVER	
3012	K	P2L	B	22	25	48		82,8	I	FIAT - LANCIA - SEAT	
3015	K	P2L	G	23	22	45		78,7	I	HONDA	
3017	K	M2L	L	33	29	47,7		83	E	BUICK - CADILLAC - CHEVROLET - OLDSMOBILE - PONTIAC	
3018		G1L	M	27	34	55,9		94,4	E	BUICK - CADILLAC - CHEVROLET - GMC - OLDSMOBILE	
3022		P3L	E	23	23	55		84	I	FORD (USA) - MERCURY	
3023	K	P2	E	26	23	51,1		82	I	FORD (USA) - MERCURY	
3024		P2	G	26	23	60		84	I	DODGE - PLYMOUTH	
3025		P2	G	26	23	54		84	I	DODGE - PLYMOUTH	
3026	K	M2	L	27	32	61,5		90,5	E	BUICK - CADILLAC - CHEVROLET - OLDSMOBILE - PONTIAC	
3027		M1L	H	26	23	54		90	I	CHRYSLER - DODGE - PLYMOUTH	
3028	K	P3L	G	30	22	52		78,8	M	SUBARU	
3029		G1L	L	27	34	55,9		94,4	E	CHEVROLET - GMC	
3031		G1	M	27	23	55,9		95,5	I	AMERICAN MOTORS	
3034	K	M1L	F	26	25	52		89,5	M	MAZDA	
3035	K	P2L	E	24	22	52		78,7	M	MAZDA - MERCURY - FORD (USA)	
3037	K	G1	O	27	34	55,9		94,4	M	BUICK - CADILLAC - OLDSMOBILE	
3039	K	P1	E	22	22	52		81	E	OPEL - PONTIAC - VAUXHALL	
3040		P1	J	26	22	54		84	I	CHRYSLER - DODGE - PLYMOUTH	
3042		P1	E	26	22	54		84	I	CHRYSLER - DODGE - PLYMOUTH	
3044	K	P2	E	25	22	50		78,7	M	CHRYSLER - DODGE - HYUNDAI - MITSUBISHI - PLYMOUTH - PROTON	
3045	K	P2	E	24	22	52		78,7	M	NISSAN-DATSUN	
3049	K	P2	E	26	23	56		82	I	TOYOTA	
3050	K	P3	H	26	24	56		84	I	TOYOTA	
3052	K	P1L	E	23	30	49		82,5	M	HONDA	
3054	K	P3	H	30	22	58		78,8	M	SUBARU	
3060	K	P2L	J	24	22	45		78,7	M	HONDA	
3062	K	M2L	L	26	30	55,8		85	I	FORD (USA) - MERCURY	
3063	K	M2	L	33	32	47,7		90,5	E	PONTIAC	
3065		P2	H	26	28	54		81,9	I	CHRYSLER - DODGE - PLYMOUTH	
3066		M2	L	26	29	54		83,8	E	CHRYSLER - DODGE - PLYMOUTH	
3068	K	P1	E	22	28	51,8		79,5	E	OPEL - VAUXHALL	
3069	K	P1	E	25	22	54,6		84	I	CITROEN - PEUGEOT	
3070	K	P3	L	30	23	52		82,5	M	SUBARU	
3073	K	M1L	H	26	25	56,5		90	E	AUDI - SAAB	
3076	K	G1	M	28	27	63		100	I	CITROEN - FIAT - PEUGEOT	
3078	K	M1L	J	26	32	51,1		87	I	FORD (USA) - MERCURY	
3079	K	P1	G	20	30	45,5		81	I	VOLKSWAGEN	
3080	K	P1	G	23	27	49		82,5	M	HONDA	
3082	K	P1	H	24	30	45		82,5	M	HONDA	
3083	K	P1	H	24	30	47		82,5	M	HONDA	
3084	K	P2	E	23	20	50		72	E	FORD (EUROPE)	
3085		M2	L	27	23	56		88,7	I	AMERICAN MOTORS	
3087	K	P2H	E	22	20	50		72	E	FORD (EUROPE)	
3089	K	P2H	H	20	25	45,5		77	I	AUDI - VOLKSWAGEN	
3090	K	P1	E	21	22	56		84	I	CITROEN - PEUGEOT	
3091	K	P1L	E	25	22	50		81	I	BLMC - BRITISH LEYLAND - ROVER	

GLO N.	KIT	PCR	PR	A	B	C	ABS	E	P		
3092	K	P2L	E	25	22	50		84	I	BLMC - BRITISH LEYLAND - ROVER	
3093	K	P1	G	23	22	49		81	I	BLMC - BRITISH LEYLAND - ROVER	
3094	K	M2H	L	23	25	56,3		90	E	RENAULT	
3095	K	M1	H	23	25	56,3		90	E	RENAULT	
3097	K	S1	S	27	32	71		84,8	I	AMERICAN MOTORS	
3098	K	M2L	H	27	23	56		90	I	NISSAN-DATSUN	
3099	K	M1L	H	25	25	56		90	E	SAAB	
3100	K	M2	J	33	25	52	29	90	E	OPEL - VAUXHALL	
3102	K	M2L	L	26	32	55,8		87	I	FORD (USA) - MERCURY	
3103	K	P3	G	33	30	53		81	I	AUDI	
3104	K	P2	E	26	22	49		80,5	I	BLMC - BRITISH LEYLAND - ROVER	
3105	K	P2	H	26	32	49		87	M	HONDA	
3106	K	P1H	E	26	30	49		82,5	M	HONDA	
3107	K	P1H	E	22	22	50		81	I	LADA	
3108	K	P2H	E	24	22	52		79	E	NISSAN-DATSUN	
3109	K	P2H	E	24	19	46		71,5	M	DAIHATSU	
3110	K	P1	E	25	22	52,2		82	I	NISSAN-DATSUN	
3111	K	P2H	E	21	22	48		82	I	NISSAN-DATSUN	
3112	K	M1	F	25	23	55,7		90	I	CITROËN - PEUGEOT	
3114	K	M2	L	33	23	47,6		87	I	BUICK - CHEVROLET	
3115	K	P2L	B	18	18	42		65,2	E	AIXAM - BELLIER - CARLETTI - CASALINI - CHATENET - FEAB - GRECAV - ISO JDM - LIGIER - MICROCAR - SAVEL-ERAD - SECMA - TASSO - VALENTINI	
3116	K	P2L	B	18	18	42		65,2	E	AIXAM	
3117	K	M1L	H	26	32	54		92	I	CHRYSLER - DODGE - PLYMOUTH	
3118	K	P1H	J	22	22	52	43	81	E	OPEL - VAUXHALL	
3119	K	P1L	C	22	22	45		80,6	I	SKODA	
3120	K	M3L	L	22	22	56		90	I	LADA	
3121	K	M1L	H	28	24	55		90	E	ALFA ROMEO	
3122	K	P3H	C	23	18	44		69,5	M	SUZUKI	
3124	K	M2L	H	25	25	50		89,7	M	HYUNDAI - MITSUBISHI	
3125	K	P3H	C	23	19	44		69,5	M	SUZUKI	
3126	K	P1H	J	22	22	52	29	81	E	OPEL - VAUXHALL	
3127	K	M2H	L	33	25	52	43	90	E	OPEL - VAUXHALL	
3128	K	M2	H	26	32	54		90,6	E	CHRYSLER - DODGE - PLYMOUTH	
3129	K	P2L	C	22	20	46		70	E	FIAT	
3130		M2	L	27	29	61,5		83,9	E	BUICK - CHEVROLET - OLDSMOBILE - PONTIAC	
3131		S1	S	33	29	73		83,9	E	CHEVROLET - OLDSMOBILE - PONTIAC	
3132		S1	S	33	32	73		90,3	E	BUICK - CHEVROLET - OLDSMOBILE - PONTIAC	
3133		S2	S	33	32	73	47	90,3	E	BUICK - CHEVROLET - OLDSMOBILE - PONTIAC	
3134		S1	S	33	32	61,5		90,3	E	BUICK - CADILLAC - OLDSMOBILE	
3135		S2	U	33	32	61,5	47	90,3	E	BUICK - CADILLAC - OLDSMOBILE	
3136		M2L	L	26	30	54		85	I	CHRYSLER - DODGE - PLYMOUTH	
3137		M2H	O	26	30	54	47	85	I	CHRYSLER - DODGE - PLYMOUTH	
3138	K	M3	N	33	30	53		90	I	AUDI	
3139	K	M3H	R	33	30	53	45	90	I	AUDI	
3140	K	P3H	O	33	30	53	45	81	I	AUDI	
3142	K	P2H	H	25	23	50		82,6	M	CHRYSLER - MITSUBISHI	
3143	K	M2L	L	25	23	52		90	I	NISSAN-DATSUN	

GLO N.	KIT	PCR	PR	A	B	C	ABS	E	P		
3144	K	P2	E	24	23	52		87	M	MAZDA	
3145	K	P3H	E	24	21	52		75,4	M	MAZDA	
3146	K	P3H	G	27	22	56		84	I	NISSAN-DATSUN	
3147	K	P2H	G	27	23	56		84	I	NISSAN-DATSUN	
3148	K	M3	J	27	32	56		92	I	NISSAN-DATSUN	
3149	K	P3H	G	21	19	48		71,5	I	NISSAN-DATSUN	
3150	K	P3H	G	23	19	48		71,5	I	NISSAN-DATSUN	
3154	K	M2H	O	27	32	61,5	47	90,5	E	PONTIAC	
3155	K	M2H	O	33	32	63	48	92	E	BUICK - OLDSMOBILE - PONTIAC	
3158	K	M1H	L	26	32	54	47	92	I	CHRYSLER - DODGE - PLYMOUTH	
3159		M2H	M	26	29	54	47	83,8	E	CHRYSLER - DODGE - PLYMOUTH	
3160	K	M2H	M	26	32	54	47	90,6	E	CHRYSLER - DODGE - PLYMOUTH	
3161	K	M2H	M	26	32	55,8	50	87	I	FORD (USA) - LINCOLN - MERCURY	
3162	K	P2	H	28	22	55		81	E	ALFA ROMEO	
3163	K	M2	L	28	34	60		97	M	HONDA	
3164	K	P1H	H	25	22	50		84	M	BLMC - BRITISH LEYLAND - ROVER	
3168	K	P1H	E	22	20	46	44	80,3	E	FIAT - LANCIA	
3174	K	P2	E	23	20	60		72	E	FORD (EUROPE)	
3176	K	M2	H	26	25	56		89,5	M	MAZDA - FORD	
3178	K	P1	H	26	23	52		82,6	M	MAZDA	
3179	K	P2	H	23	27	45		82,5	M	HONDA	
3180	K	M2	H	28	32	60		97	M	HONDA	
3181	K	P3	G	22	22	50		78,7	I	ISUZU	
3182	K	P3	G	22	21	50		74,5	M	ISUZU	
3188	K	M1H	L	23	24	56,3		86,8	I	RENAULT	
3189	K	M1L	H	25	25	56,6		90	E	SAAB	
3190	K	P3H	J	30	23	58		82,6	M	SUBARU	
3191	K	M3	N	30	25	58		90	M	SUBARU	
3192	K	M2	L	27	30	56		87	M	SUBARU	
3195	K	P3L	E	24	19	44		71,5	M	DAIHATSU	
3196	K	P2	E	23	19	49		71,5	I	HONDA	
3197	K	P2	E	23	21	49		75	I	HONDA	
3198	K	P3L	L	24	18	50		71,2	M	SUBARU	
3199	K	P3L	L	24	19	50		71,2	M	SUBARU	
3200	K	G1H	S	26	28	56,5	45	98	E	AUDI	
3201	K	M1H	P	26	25	56,5	45	90	E	AUDI	
3202	K	M3H	R	33	30	53	96	90	I	AUDI	
3209	K	P3H	G	21	19	48		71,5	M	NISSAN-DATSUN	
3210	K	M1H	H	25	34	55,7	48	90	I	CITROËN - PEUGEOT	
3211	K	P1H	H	26	23	49		87	M	HONDA	
3212	K	M1L	E	22	25	51		90	E	AUDI - VOLKSWAGEN	
3213	K	G2	R	38	33	60		98	I	VOLKSWAGEN	
3214	K	P1H	J	26	32	49	100	87	M	HONDA	
3215	K	M1L	H	25	24	52		90	E	ALFA ROMEO	
3216	K	P1H	H	24	22	54		79,2	M	DAIHATSU	
3217	K	M2	H	25	23	50		89,7	M	HYUNDAI - MITSUBISHI	
3218	K	P2	H	23	23	56		82	I	TOYOTA	
3219	K	P2H	H	25	30	50		82,6	M	MITSUBISHI	

GLO N.	KIT	PCR	PR	A	B	C	ABS	E	P		
3220	K	P1H	H	26	32	55		87	M	HONDA	
3221		S3	S	33	29	80		110	E	CHEVROLET - GMC	
3222		S2	S	33	35	77		101,3	E	CHEVROLET - GMC	
3223	K	M1H	O	26	25	56	46	90	E	SAAB	
3224	K	M1H	O	25	25	56	94	90	E	SAAB	
3226	K	M1L	F	25	25	53		90	E	MOSKVICH	
3228	K	P2H	H	26	23	56		82,6	M	MAZDA	
3229	K	P2H	H	27	22	56		82,6	M	SUBARU	
3230	K	G1	M	26	25	56,5		98	E	SAAB	
3231	K	G1H	O	26	25	56	46	98	E	SAAB	
3232	K	M3	N	30	25	46,9		90	E	SAAB	
3233	K	G1	O	27	25	56		100	I	NISSAN-DATSUN	
3234	K	M1H	H	22	25	50,8	96	90	I	AUDI	
3235	K	M2H	J	26	25	56		89,7	I	TOYOTA	
3236	K	P3L	C	23	19	44		71,5	E	DAEWOO	
3238	K	P2H	G	26	22	56		78,7	I	KIA - MAZDA	
3239	K	P3H	G	26	21	56		75,4	I	MAZDA	
3240	K	M1H	L	25	23	55,7	90	90	I	CITROËN - PEUGEOT	
3241	K	M1H	L	25	23	55,7	48	90	I	CITROËN	
3242	K	M1H	L	25	23	55,7	29	90	I	CITROËN	
3243	K	M1H	L	28	23	58	48	90	I	CITROËN - PEUGEOT	
3244	K	G2H	R	28	27	58	48	100	I	CITROËN - PEUGEOT	
3245	K	M1	H	27	25	56		89,8	I	FIAT - LANCIA	
3246	K	M1H	L	27	25	56	44	89,8	I	FIAT - LANCIA	
3247	K	P2H	J	22	25	48	64	81	I	FIAT	
3248	K	G1	O	27	28	56		98	E	ALFA ROMEO - LANCIA	
3250	K	G1H	O	27	28	56	44	98	E	ALFA ROMEO - LANCIA	
3251	K	M1H	L	27	25	60	44	89,8	I	LANCIA	
3252	K	G1H	O	25	28	56	44	98	E	ALFA ROMEO - FIAT	
3253	K	G1H	P	28	39	63	54	99	I	FIAT	
3254	K	S3	S	35	45	70	54	115	I	FIAT	
3256	K	P1H	E	23	22	48		81	E	FORD (EUROPE)	
3257	K	P2H	E	25	22	56,5		84	E	FORD (EUROPE)	
3258	K	P3	L	24	18	50		71,2	M	SUBARU	
3259	K	P3	L	24	19	50		71,2	M	SUBARU	
3260	K	P2	E	24	19	54		71,5	M	DAIHATSU	
3261	K	P2H	H	25	22	50		78,7	I	DODGE - MITSUBISHI	
3263	K	M2H	M	28	34	60	50	97	M	ACURA - HONDA	
3264	K	P3H	G	24	30	46		81	E	FORD (BRAZIL)	
3265	K	P3L	E	24	30	46		81	I	FORD (BRAZIL)	
3266	K	P2L	E	23	30	55		81	I	FORD (BRAZIL)	
3267	K	P2H	J	26	23	56		82,6	M	MAZDA	
3268	K	M3	J	25	23	55		90	I	NISSAN	
3269	K	M3H	L	25	23	55	42	90	I	NISSAN	
3270	K	M3	L	25	25	55		89,7	I	NISSAN	
3271	K	P2	E	25	22	55		82	I	NISSAN	
3272	K	M1	F	22	29	51,8		84	E	DAEWOO	
3273	K	M1	H	25	34	55,7		90	I	PEUGEOT	

GLO N.	KIT	PCR	PR	A	B	C	ABS	E	P		
3274	K	P1	H	23	30	45		82,5	M	HONDA	
3277	K	M1H	L	26	25	56,5	48	90	E	VOLVO	
3278	K	S3	P	35	45	70		115	I	CITROËN - FIAT - PEUGEOT	
3279	K	M1	H	26	25	56		89,5	M	MAZDA	
3280	K	G2H	S	38	27	59,5	45	98	I	AUDI - VOLKSWAGEN	
3281	K	P3	E	23	19	49		71,5	M	SUZUKI	
3283	K	M1H	O	26	25	56,5	96	90	E	AUDI	
3284	K	G2H	S	38	28	59,5	45	98	E	AUDI	
3285	K	P3	E	24	19	40		71,5	M	DAIHATSU	
3286	K	P2	G	26	30	56		82,6	I	MAZDA	
3287	K	M1H	O	27	34	59	48	90	I	CITROËN - FIAT - LANCIA - PEUGEOT	
3288	K	G1H	P	27	39	59	48	100	I	CITROËN - FIAT - LANCIA - PEUGEOT	
3289	K	P2L	E	23	22	49		78,7	M	SUZUKI	
3290	K	M1H	O	22	30	51	96	90	I	AUDI - VOLKSWAGEN	
3291	K	M3	N	38	25	59,5		90	E	AUDI	
3292	K	M3H	R	38	25	59,6	45	90	E	AUDI	
3293	K	M3	N	38	30	59,4		90	E	AUDI	
3294	K	M2	N	27	25	56		95	M	SUBARU	
3295	K	M2	L	26	27	56		89,7	I	LEXUS - TOYOTA	
3296	K	P2	E	26	23	56		82	I	TOYOTA	
3299	K	P2	J	26	30	56		82,6	I	MAZDA	
3300	K	M1	F	21	25	56,3		90	E	RENAULT	
3301	K	G1	R	26	28	56,4		98	E	AUDI	
3302	K	G2H	S	38	27	59,5	45	98	I	AUDI	
3303	K	M1	H	23	25	56,3		90	E	RENAULT	
3304	K	P1H	H	22	30	51	96	81	E	AUDI	
3305	K	M2	H	33	29	51,8		84	E	DAEWOO	
3306	K	M2	F	23	29	57,5		83,6	E	RENAULT	
3307	K	P1	H	22	30	53		81	I	SEAT - VOLKSWAGEN	
3308	K	M2H	L	25	34	55	90	90	I	CITROËN - PEUGEOT	
3309	K	M2	H	25	23	54		87	M	MITSUBISHI	
3310	K	P2	H	25	23	54		82,6	M	MITSUBISHI	
3311	K	M3H	R	38	30	59,6	45	90	E	AUDI	
3313	K	G1H	R	26	28	56,6	96	98	E	AUDI	
3314	K	M3H	L	25	25	55	42	89,7	I	NISSAN	
3315	K	P3	F	23	19	44		71,5	M	DAEWOO	
3316	K	P1	E	22	22	46		80,3	E	FIAT	
3317	K	P1H	H	22	22	46	44	80,3	E	FIAT	
3318	K	M1H	F	25	25	59	44	89,8	E	FIAT	
3320	K	P1	G	22	22	42		83	I	ZAZ	
3321	K	M2	J	28	23	56		87	I	FORD (USA) - MAZDA	
3322	K	M2	L	28	26	56		94	I	FORD (USA) - MAZDA	
3323	K	P2H	H	25	30	54	43	82	M	PROTON - MITSUBISHI	
3324	K	P3	F	24	20	44		71,5	I	DAIHATSU	
3325	K	P2	E	25	30	54		82	M	PROTON - MITSUBISHI	
3326	K	P2	E	25	22	54		79	M	PROTON - MITSUBISHI	
3328	K	M1	G	25	24	54		85,7	M	PROTON - MITSUBISHI	
3329	K	M1H	I	25	24	54	43	85,7	M	PROTON - MITSUBISHI	

GLO N.	KIT	PCR	PR	A	B	C	ABS	E	P		
3330	K	P2	E	21	30	46,3		81	E	RENAULT	
3331	K	P2	E	24	30	52		84	E	MAZDA	
3332	K	M1	E	25	30	56,5		84	I	FORD (BRAZIL) - VOLKSWAGEN	
3333	K	M1	E	25	30	56,5		90	I	FORD (BRAZIL) - VOLKSWAGEN	
3335	K	P1	E	25	31	54,6		84	I	PEUGEOT	
3336	K	P1	B	22	20	52		81	E	FIAT	
3337	K	P3	E	24	21	54		75,3	M	DAIHATSU	
3338	K	M1H	O	25	25	79	46	90	E	SAAB	
3339	K	M1H	L	26	25	79	94	90	E	SAAB	
3340	K	M1	H	36	30	53		90	I	SEAT - VOLKSWAGEN - SKODA	
3342	K	M2	H	25	22	52		90	E	FIAT	
3343	K	M2H	L	25	22	52	44	89,8	E	FIAT	
3344	K	M2	H	25	25	52		90	E	ALFA ROMEO - FIAT	
3345	K	M2H	H	25	25	52	44	89,8	E	ALFA ROMEO - FIAT	
3346	K	G2	L	25	28	56		98	E	FIAT	
3347	K	G2H	S	38	33	60	48	98	I	VOLKSWAGEN	
3348	K	M1	L	27	34	59		90	I	FIAT	
3349	K	G1	L	27	39	59		100	I	FIAT	
3350	K	G1H	O	33	25	52	29	90	E	SAAB	
3351	K	M1	J	28	23	57,7		90	I	CITROËN - PEUGEOT	
3352	K	G1	M	28	27	57,7		100	I	CITROËN - PEUGEOT	
3353	K	G1	M	28	39	63		100	I	FIAT	
3354	K	P3	E	25	22	56,6		81	E	FORD (EUROPE)	
3355	K	M1	H	25	25	56,6		90	E	FORD (EUROPE)	
3356	K	M1H	N	27	25	57	44	87	I	FORD (EUROPE)	
3357	K	M1H	L	27	30	57	44	82	I	FORD (EUROPE)	
3358	K	M1H	J	27	25	57		87	I	FORD (EUROPE)	
3359	K	P2H	G	22	28	52	29	79,5	E	OPEL - OPEL (EUROPE) - VAUXHALL	
3360	K	P2H	G	22	22	52	29	81	E	OPEL - VAUXHALL	
3363	K	P1	B	22	22	52		81	E	FIAT	
3364	K	P1H	E	22	22	52	44	81	E	FIAT	
3365	K	M2	F	23	27	56,3		90	I	RENAULT	
3366	K	M2H	I	25	27	56,3		90	I	RENAULT	
3367	K	M3	E	25	24	52,2		90	I	NISSAN	
3368	K	M3L	E	25	24	55		90	I	NISSAN	
3369	K	G2	R	38	27	60		98	I	VOLKSWAGEN	
3370	K	G2H	S	38	27	60	48	98	I	VOLKSWAGEN	
3371	K	P3L	G	24	19	52		71,2	M	MAZDA - FORD - KIA	
3372	K	P3	G	24	20	52		71,2	M	MAZDA - FORD	
3373	K	M2H	I	33	29	52	47	84	E	DAEWOO	
3374	K	P1	H	26	30	55		82,5	I	HONDA	
3375	K	M2	L	26	32	56		87	I	TOYOTA	
3376	K	P2	H	26	22	56		78,7	I	MAZDA	
3377	K	M3L	J	27	25	56		89,7	I	NISSAN	
3378	K	M3L	J	29	25	56		89,7	I	NISSAN	
3379	K	P2	E	25	30	55		87	I	NISSAN	
3380	K	P3L	E	23	22	48		78,7	I	NISSAN	
3381	K	M1H	H	33	30	53	45	90	I	AUDI - VOLKSWAGEN	

GLO N.	KIT	PCR	PR	A	B	C	ABS	E	P		
3382	K	P3L	E	20	30	48		81	I	RENAULT	
3383	K	P3L	E	20	30	48		80,7	E	RENAULT	
3384	K	M3L	L	25	25	52,3		89,7	I	NISSAN	
3385	K	P3H	H	23	22	48	42	81	I	NISSAN	
3386	K	M2L	H	33	24	47,6		87	I	BUICK (G.M.)	
3387	K	M2L	F	26	24	50		90	I	FORD (USA)	
3388	K	M2L	E	26	24	56		90	I	CHRYSLER	
3389	K	P1H	H	26	23	49		83,6	I	HONDA - ROVER	
3390	K	P3	E	27	21	50		75,3	M	SUBARU	
3391	K	P3L	F	23	22	48		80,8	I	NISSAN	
3392	K	P3L	E	23	19	48		72,3	I	NISSAN	
3393	K	P3H	H	23	19	48	42	72,3	I	NISSAN	
3394	K	G1H	R	30	34	56	48	94,3	I	TOYOTA	
3395	K	G1	P	30	34	56		94,3	I	TOYOTA	
3396	K	M2L	E	23	28	58		82	I	CHRYSLER	
3397	K	M2H	H	33	29	47,7	48	84,6	E	CHEVROLET (G.M.)	
3399	K	P3H	H	26	24	56	48	85,5	I	TOYOTA	
3400	K	M2H	H	28	32	60	50	96	M	HONDA	
3401	K	P2L	C	25	20	56,5		72	E	FORD (EUROPA)	
3402	K	P2	C	22	30	52		83	I	OPEL	
3403	K	P2H	H	22	30	52	29	83	I	OPEL	
3404	K	P2	G	22	22	50		80,5	E	VOLVO	
3405	K	P2H	L	22	22	50	44	80,5	E	VOLVO	
3406	K	M2H	J	23	28	58	56	82	I	CHRYSLER	
3407	K	M1	H	21	25	56,3	26	90	E	RENAULT	
3408	K	M3	L	29	25	56	46	89,7	I	NISSAN	
3409	K	P2H	L	26	30	56	44	82,6	I	MAZDA	
3410	K	M2H	P	28	26	56	44	94	I	MAZDA	
3411	K	P1H	J	26	32	49	27	92	I	ROVER	
3412	K	M1H	P	28	23	58	29	90	I	CITROËN - PEUGEOT	
3413	K	G2H	S	28	27	58	29	100	I	CITROËN - PEUGEOT	
3414	K	M1H	P	26	25	56	90	89,5	M	MAZDA	
3415	K	P1	H	26	30	55		87,3	M	HONDA	
3416	K	M2L	E	25	30	54		82,6	I	MITSUBISHI	
3417	K	P2L	E	25	22	49		79	M	SUZUKI	
3418	K	P3L	G	25	21	49		73,8	I	SUZUKI	
3420	K	P1L	E	21	31	56		84	I	CITROËN	
3422	K	P3H	L	27	22	56	42	84	I	NISSAN	
3423	K	P2H	L	27	23	56	42	84	I	NISSAN	
3424	K	M3H	N	27	32	56	42	92	I	NISSAN	
3425	K	P3L	C	23	18	49		68	M	HONDA	
3426	K	P2H	L	25	22	55	42	82	I	NISSAN	
3427	K	M2H	P	26	32	56	48	87	I	TOYOTA	
3428	K	P2L	J	23	21	56		80	I	TOYOTA	
3429	K	P2L	H	26	22	56		80	I	TOYOTA	
3430	K	P2H	J	26	22	56	48	80	I	TOYOTA	
3431	K	M2L	E	22	28	52		82	I	GMC	
3432	K	P1L	E	36	30	53		81	I	AUDI - SKODA - VOLKSWAGEN	

GLO N.	KIT	PCR	PR	A	B	C	ABS	E	P		
3433	K	P2H	L	26	22	49	50				ROVER
3434	K	P1H	L	26	32	55	50	91	M		HONDA
3435	K	M2H	R	25	30	54	43	82,7	I		MITSUBISHI
3436	K	M2	O	26	32	49		92	I		ROVER
3437	K	M2	H	26	30	56		85	I		TOYOTA
3438	K	M1	G	25	25	59		88	E		ALFA ROMEO
3439	K	P2H	H	23	23	56	48	82	I		TOYOTA
3440	K	P3H	H	26	28	56	44	82	I		FORD (USA)
3441	K	P3H	H	25	21	49	42				SUZUKI
3442	K	P3H	H	25	20	49	42				SUZUKI
3443	K	P2H	H	25	22	49	42	79	I		SUZUKI
3444	K	P3	E	25	19	49		71,5	I		SUZUKI
3445	K	M2H	L	26	27	56	48				TOYOTA
3446	K	M1	F	26	23	54		90	I		CHRYSLER
3447	K	M1	F	26	32	54		90	I		CHRYSLER
3448	K	M1	F	26	23	51,1		89,7	I		MERCURY (FORD USA)
3449	K	P3	F	26	22	56		76,5	I		TOYOTA
3450	K	M2	F	33	32	50		87	I		GMC
3451	K	M1	D	25	32	55		87	I		NISSAN-DATSUN
3452	K	P2	B	27	18	43		68	M		MITSUBISHI
3453	K	G2	R	27	27	60		98	I		MERCEDES
3454	K	P2H	G	25	30	50	29	83	M		HYUNDAI
3455	K	M2H	L	25	23	50	29	87	M		HYUNDAI
3456	K	M2	O	25	26	54		94,5	I		DODGE - MITSUBISHI
3457	K	P3	E	24	19	40		71	M		DAIHATSU
3458	K	P2	E	25	22	54		79	M		DODGE - EAGLE - MITSUBISHI
3459	K	M1	H	25	25	50		89,5	M		MITSUBISHI
3460	K	P2	F	25	23	54		85	I		MITSUBISHI
3461	K	M2	O	25	26	50		95	M		HYUNDAI - MITSUBISHI
3462	K	M1H	M	25	34	55,3	29	88	I		PEUGEOT
3463	K	S3	R	30	27	61,76		92,4	I		TOYOTA
3464	K	S3	R	30	24	57		104,6	I		TOYOTA
3465	K	S3	S	35	45	70	54	122	I		CITROËN - FIAT - PEUGEOT
3466	K	M2H	L	26	23	49	50	91	I		HONDA
3467	K	P2	E	24	22	54		81	I		CITROËN
3468	K	G1	R	25	28	59		98	E		ALFA ROMEO
3469	K	M1	F	25	32	55		87	I		NISSAN-DATSUN
3470	K	M1	H	26	25	65		90	M		MAZDA
3471	K	M1H	L	25	25	52	44	90	I		ALFA ROMEO
3472	K	P2H	F	23	19	46	40	76	E		DAEWOO
3473	K	G2H	S	25	39	59	48	100	I		CITROËN
3474	K	M1H	R	25	34	55,7	29	99,8	I		PEUGEOT
3475	K	M2H	R	28	32	60	50	98	I		HONDA
3476	K	P2	E	33	22	52		81	E		OPEL - VAUXHALL
3477	K	P2H	G	26	22	55	43	93	I		ROVER
3478	K	M2	H	33	25	52		90	E		OPEL - VAUXHALL
3479	K	M2H	L	33	25	52	29	90	E		OPEL - VAUXHALL
3480	K	P2	E	33	28	52		74	E		OPEL - VAUXHALL

GLO N.	KIT	PCR	PR	A	B	C	ABS	E	P		
3481	K	G2H	S	25	34	59	29	100	I	PEUGEOT	
3482	K	P1	B	22	21	51		75	M	FIAT	
3483	K	M1	H	27	25	59		90	E	ALFA ROMEO	
3484	K	P3	F	26	22	55		84	I	ROVER	
3485	K	G1	R	27	28	59		98	E	ALFA ROMEO	
3486	K	M1H	L	26	28	55	50	91	M	HONDA	
3487	K	M1H	L	25	34	59	29	90	I	CITROËN - PEUGEOT	
3488	K	M1H	L	26	22	49	43	93	I	ROVER	
3489	K	P2	C	25	22	55		82	I	NISSAN-DATSUN	
3490	K	P2	F	25	22	51		83	E	FIAT	
3491	K	M3H	L	33	30	53	45	87,9	I	AUDI	
3492	K	P1	D	22	20	51		80	E	FIAT	
3493	K	M2H	L	21	22	51	44	85	I	RENAULT	
3494	K	M1	F	33	29	52		84	E	DAEWOO	
3496	K	G1H	R	28	23	56	44	97	I	MAZDA	
3497	K	M2H	L	23	25	56,3	30	90	E	RENAULT	
3498	K	P3	F	26	30	55		80	M	HONDA	
3499	K	M3	K	28	34	60		95,6	M	HONDA	
3500	K	G2H	S	27	27	60	48	98	I	MERCEDES	
3501	K	P1L	B	20	20	43,1		81	E	AUTOBIANCHI - FIAT - FORD (BRAZIL) - INNOCENTI - LANCIA - SEAT - ZASTAVA	
3502	K	P2H	G	24	22	52	44	78,7	I	FORD	
3504	K	P1L	B	22	20	48		81	E	FIAT - LANCIA - ZASTAVA	
3505	K	P1L	C	22	30	51		81	E	VOLKSWAGEN (BRAZIL)	
3506	K	P2	E	24	21	52		75,4	I	FORD	
3507	K	G2H	R	32	34	62	50	94,5	I	NISSAN	
3508	K	P3L	G	25	20	49		73,8	M	SUZUKI	
3521	K	M1L	F	26	23	54		88,6	I	CHRYSLER - DODGE - PLYMOUTH	
3532	K	P3	E	23	19	44		70	M	SUZUKI	
3538	K	M2L	G	33	25	52		90	E	OPEL - VAUXHALL	
3547	K	M1L	E	22	30	51		90	I	AUDI - FORD (BRAZIL) - SEAT - VOLKSWAGEN	
3548	K	P1L	C	22	30	51		81	I	AUDI - FORD (BRAZIL) - SEAT - VOLKSWAGEN - VOLKSWAGEN (BRAZIL)	
3556	K	P2	E	23	22	45		78,7	M	HONDA	
3581	K	P1	G	26	32	49		87	M	HONDA	
3596	K	M2	L	26	29	56		84	E	CHEVROLET - GEO	
3667	K	P1L	E	22	20	46		80,4	E	FIAT - LANCIA	
3671	K	M1	O	25	25	52	90	89,8	I	FIAT - LANCIA	
3673	K	M1	H	25	25	52	44	89,8	I	ALFA ROMEO - FIAT - LANCIA	
3675	K	P2L	E	23	22	55		81	E	FORD (EUROPE)	
3686	K	P2	E	24	22	52		82	I	NISSAN-DATSUN	
3706	K	M1L	E	25	25	52		90	I	ALFA ROMEO - FIAT - LANCIA	
3749	K	G1H	S	27	28	56	90	98	E	ALFA ROMEO - LANCIA	
4005	K	W1	C		33	91,8				AUDI - SEAT - VOLKSWAGEN	
4015	K	W2	B	18	18	62				AIXAM - BELLIER - CARLETTI - CASALINI - CHATENET - FEAB - GRECAV - ISO JDM - LIGIER - MICROCAR - SAVEL-ERAD - SECMA - TASSO - VALENTINI	
4038	K	W3	L	34	22	84				OPEL	
4039	K	W2	P	22	22	84				OPEL	
4047	K	W2	E		33	100				VOLKSWAGEN	

GLO N.	KIT	PCR	PR	A	B	C	ABS	E	P	
4048	K	W2	E		33	100				AUDI - VOLKSWAGEN
4049	K	W2	L	23	20	75				FORD (EUROPA)
4050	K	W3	P	23	22	82				FORD (EUROPA)
4051	K	W3	H		28	108				ALFA ROMEO - AUDI - VOLKSWAGEN
4052	K	W3	P		33	100				OPEL - VAUXHALL
4053	K	W3	L		24	94				VOLVO
4060		W1	E		24	94				HOLDEN
4061		W2	E		25	100				HOLDEN
4121	K	W1	C		24	94				ALFA ROMEO
4213	K	W3	P		33	108				AUDI - VOLKSWAGEN
4283	K	W2	J		33	100				AUDI
4302	K	S2	S		28	108				FERRARI - PORSCHE
4334	K	W2	C		33	100				VOLKSWAGEN (BRAZIL)
4345	K	W2	C		25	100				ALFA ROMEO - FIAT
4369	K	W3	K		28	108				VOLKSWAGEN
4401	K	S2	S		28	108				MASERATI
4485	K	W3	K		28	108				ALFA ROMEO
4501	K	S2	S		28	108				LAMBORGHINI - MERCEDES-BENZ - OPEL (EUROPE) - VAUXHALL
4511	K	W1	C		33	94				AUDI - FIAT - SEAT - SKODA - VOLKSWAGEN
4512	K	W2	E		25	100				ALFA ROMEO - FIAT - LANCIA - FORD (EUROPE) - MOSKVICH
7001		Z1	V	22	33					VOLKSWAGEN
7002		Z1	V	22	33					VOLKSWAGEN
7003		Z1	V	22	33					VOLKSWAGEN
7004		Z1	V	22	33					VOLKSWAGEN
7005		Z1	V	22	33					VOLKSWAGEN
7006		Z1	V	22	33					VOLKSWAGEN
7007		Z1	V	22	33					VOLKSWAGEN
7008		Z1	V	22	33					VOLKSWAGEN
7009		Z1	V	22	33					AUDI - VOLKSWAGEN
7010		Z1	V	22	33					VOLKSWAGEN
7013		Z2	V	33	33					VOLKSWAGEN
7015		Z2	V	33	33					VOLKSWAGEN
7226		Z2	V	25	25					MOSKVICH

ALTERNATIVE TO OEM NO	GLO NO
ACURA	
S. 44014-SD4-950	3263
ALFA ROMEO	
700611	4121
4315132	4512
7698900	3706
9936769	4512
46307246	3468
46307301	3438
46307308	3483
46307515	4485
60559887	3471
60810018	3706
60815163	3485
82362524	3706
82486231	3706
82489521	3250
431407331-DIES	4051
431407331G	4051
431498103C	4051K
82301373	3706
82333811	3706
82362523	3706
82428432	3706
82439756	3706
82440166	3706
S. SX/DX 11646.17047.01	3706
S. SX/DX 16400.17047.01	3706
S. SX/DX 547.679	3162
S. SX/DX 547.680	3121
S. SX/DX 547.682	3121
S. SX/DX 548.135	3121
S. SX/DX 605 065 36	3121
S. SX/DX 795.283	3162
S. SX/DX 795.284	3121
AMERICAN MOTORS	
8131441	3031
8132441	3031
8132833	3031
8983500497	3085
8983500696	3097
8983500698	3097
AUDI	
7656944	3706
321498099	3505K
437407305	3283
443407311	3291
893407305	3290
171407311D	3505

ALTERNATIVE TO OEM NO	GLO NO
171407311E	3089
171407311L	3548
171407311P	3547
171407331H	4511
171407331K	4511
171407331L	4005
171498103C	4511K
171498103D	4005K
191407331	4048
191.598.099	3548K
1H0 407 311 C	3548K
1H0407331B	4048
321407271AG	7009
321407271N	7009
321407331	4511
321407331D	4048
321498099B	3548K
321498099C	3547K
321.498.099E	3548K
321.498.099F	3548K
321498103	4511K
321498103B	4048K
431407275	3073
431407311A	3073
431407311C	3301
431407331-DIES	4051
431407331G	4051
431498099A	3073K
431498099E	3073K
431498103C	4051K
437407305A	3313
437407311A	3283
441407305B	3302
441407305G	3284
443407305B	3292
443498099DX	3291
443 498 099 G	3200K
447 407 305 A	3200
4A0.407.305A	3311
4A0407305A	3293
4A0.407.305F	3311
4A0407311B	3302
4A0407311C	3293
4D0498099	3280
4A0.498.099B	3311
4A0.498.099C	3311
803498099A	3073K
811407305A	3234
811407311	3547

ALTERNATIVE TO OEM NO	GLO NO
811498099	3547K
811498099A	3234K
811.498.099F	3548K
823.407.313	3505
855407311	3212
855498099	3212K
855498099A	3212K
855498099B	3212K
861498099	3089K
893407305C	3304
893.407.305N	3139
893.407.311	3547
893407311D	3138
893498099B	3138K
893498099E	3103K
893498099F	3138K
893498099H	3138K
893.498.099P	3491
893498103	4048K
895-407-305A	3311
895407305	3140
895407305B	3139
895407311	3103
895498099A	3139K
895498099B	3140K
895498099H	3139K
ZBA407311	3505
ZBC407311	3548
ZBC407331	4511
ZBC407331F	4511
8A0.407.305G	3491
8DO.498.099B	3381
8DO.407.305G	3381
AUTOBIANCHI	
4087120	3501
4247399	3501
4308412	3501
4308413	3501
4313087	3501
4328468	3501
4465504	3501
4465504	3501
5944689	3501
5944690	3501
5944690	3501
5959385	3501
5998706	3501
5998706	3501

ALTERNATIVE TO OEM NO	GLO NO
BLMC	
03CGV1053	3104
17H8600	3006
27H7567	3009
BAU 4414	3164
BAU 4851	3093
BAU 5466	3091
BAU 5467	3092
GCV1105	3006
BRITISH LEYLAND	
03CGV1053	3104
17H8600	3006
27H7567	3009
BAU 4414	3164
BAU 4851	3093
BAU 5466	3091
BAU 5467	3092
GCV1105	3006
BUICK (GENERAL MOTORS)	
7831589	3037
7832259	3017
7835070	3018
7835075	3037
7837075	3026
7842037	3026
7843919	3026
7844793	3017
7845005	3037
7845009	3017
7845024	3026
7845070	3018
26000690	3133
26008329	3133
26008330	3132
26011523	3130
26017183	3134
26017184	3135
26017201	3134
26017202	3135
26020958	3133
26020959	3132
26020961	3134
26020962	3135
26026732	3130
26030481	3132
93412172	3114K
325604	3386
CADILLAC (GENERAL MOTORS)	
7831589	3037

ALTERNATIVE TO OEM NO	GLO NO
7832259	3017
7835070	3018
7835075	3037
7837075	3026
7842037	3026
7843919	3026
7844793	3017
7845005	3037
7845009	3017
7845024	3026
7845070	3018
26017183	3134
26017184	3135
26017201	3134
26017202	3135
26020961	3134
26020962	3135
CHEVROLET (GENERAL MOTORS)	
7832259	3017
7835070	3018
7837075	3026
7841224	3029
7842037	3026
7843919	3026
7844793	3017
7845009	3017
7845024	3026
7845070	3018
7849313	3221
7849841	3596
26000690	3133
26001362	3222
26003175	3222
26008329	3133
26008330	3132
26011523	3130
26012744	3221
26020728	3221
26020731	3222
26020958	3133
26020959	3132
26026732	3130
26026736	3131
26030481	3132
93412172	3114K
26039155	3397
CHRYSLER	
4186691	3521
4205852	3521

ALTERNATIVE TO OEM NO	GLO NO
4292382	3521K
4367001	3066
4384702	3117
4384734	3117
4641019	3128
4641021	3159
4641329	3136
4641330	3137
4670012	3160
4670013	3128
5212606	3521
5212712	3027
5212789	3027
5212830	3065
5212856	3042
5212869	3040
4284006R	3521K
325477	3446
325640	3388
326300	3447
326808	3396
326807	3406
CITROËN	
2108 2215011	3112
3272.60	3413
3272-Y3	3487
3273-Z8	3473
327200	3090
327220	3090
327355	3090
327364	3090
327365	3090
327366	3090
327367	3090
327389	3090
95598210	3090
95643689	3240
95646292	3076
95653009	3244
95653010	3243
95656595	3242
96995952	3467
9567582280	3465
9617408188 SX	3288
9617408288 DX	3288
9619947580 SX	3287
9619947680 DX	3287
S. 96141637	3210
S. DX 327210	3112

ALTERNATIVE TO OEM NO	GLO NO
S. DX 327360	3076
S. DX 327362	3076
S. DX 95606803	3076
S. DX 95606804	3076
S. SX 327318	3069
S. SX 327323	3069
S. SX 327360	3076
S. SX 327379	3112
S. SX 327483	3069
S. SX 327485	3069
S. SX 327486	3069
S. SX 95606802	3076
S.DX 3273C7	3076
DAEWOO	
510736	3494
26010774	3305
26013813	3272
96160589	3373
96273571	3472
DAIHATSU	
43460-87B82-000	3324
43470-87298-000	3224
S. DX 43400-87728	3109
S. DX 43410-87000	3109
S. DX 43410-87710	3109
S. DX 43410-87710	3109
S. DX 43410-87711	3109
S. DX 43410-87714	3109
S. DX 43410-87715	3109
S. DX 43410-87726	3109
S. DX 43410-87727	3109
S. DX 43410-87729	3109
S. DX 43410-87731	3109
S. DX 43410-87732	3109
S. DX 43410-87733	3109
S. DX 43410-87735	3109
S. SX 43420-87000	3109
S. SX 43420-87710	3109
S. SX 43420-87710	3109
S. SX 43420-87711	3109
S. SX 43420-87726	3109
S. SX 43420-87727	3109
S. SX 43420-87731	3109
S. SX 43420-87735	3109
43410-87223	3195
43420-87223	3195
43410-87225	3195
43420-87225	3195
43410-87242	3195

ALTERNATIVE TO OEM NO	GLO NO
43420-87242	3195
43410-87703	3457
43410-87706	3457
DODGE (CHRYSLER)	
4186691	3521
4186890	3025
4205852	3521
4367001	3066
4384702	3117
4384734	3117
4641019	3128
4641021	3159
4641329	3136
4641330	3137
4670012	3160
4670013	3128
5212606	3521
5212712	3027
5212789	3027
5212830	3065
5212856	3042
5212869	3040
52112591	3024
FIAT	
4087120	3501
4247399	3501
4308412	3501
4308413	3501
4313087	3501
4315132	4512
4328468	3501
4390952	3504
4393155	3012
4393157	3012
4465504	3501
4465504	3501
4475837	3504
5944689	3501
5944690	3501
5944690	3501
5959385	3501
5998706	3501
5998706	3501
7373193	3012
7611232	3247
7629457	3667
7631082	3168
7633434	3706
7656786	3504

ALTERNATIVE TO OEM NO	GLO NO
7656787	3247
7656944	3706
7656949	3673
7659161	3168
7659169	3667
7659169	3667
7688157	3673
7688157	3673
7698632	3012
7698900	3706
7698900	3706
7717273	3247
7750300	3673
7758266	3336
9936769	4512
46307032	3344
46307034	3345
46307082	3342
46307083	3343
46307094	3316
46307108	3317
46307121	3364
46307122	3363
46307234	3490
46307394	3492
46307557	3482
46429632	3318
60605055	3673
60809609	3252
60810018	3706
60811033	3673
60812880	3346
82362524	3706
82413699	3671
82443532	3671
82449123	3671
82466864	3673
82466864	3246
82466865	3245
82480859	3671
82486230	3673
82486230	3673
82486231	3706
92601903	3667
95646292	3076
9566722180	3253
9566722380	3254
9567582280	3465
7560070	3504

ALTERNATIVE TO OEM NO	GLO NO
7577041	3504
76472452A	3129
82301373	3706
82333811	3706
82362523	3706
82428432	3706
82439756	3706
82440166	3706
9617408188 SX	3288
9617408288 DX	3288
9619947580 SX	3287
9619947680 DX	3287
S. DX 327360	3076
S. DX 327362	3076
S. DX 3273C7	3076
S. DX 95606803	3076
S. DX 95606804	3076
S. SX 327360	3076
S. SX 95606802	3076
S. SX/DX 11646.17047.01	3076
S. SX/DX 16400.17047.01	3076
46307047	3336
7085573	3363
80078574	3364
FORD (BRAZIL)	
55.407.311	3265
90AU-3K183-AA	3266
BD5M-3W427A	3264
FORD (EUROPE)	
1003550	3354
1023250	3357
1493963	4512
6071774	3084
6079195	3675
6168422	3174
6483685	3257
6485414	3256
6485415	3355
7024787	3357
7024788	3357
7294547	3358
72GG-4635-BA	4512
77TT-3K187-EA	3087
79TT-3K-187-AA	3084
79TT3K187BA	3675
81AG-3K-187-AA	3675
92AG3K183BA	3257
92AG3K183M	3355
92AG3K187BA	3257

ALTERNATIVE TO OEM NO	GLO NO
92AG3K187M	3355
93BG3B413BE	3358
96AG3K183BB	3354
96BG3B413AAB	3357
1003548	3401
FORD (USA)	
6069110	3062
81AG3A187AA	3062
E2GZ-3B413-A	3022
E3FZ-3B413-B	3023
E43Z-3B413-B	3078
E6DZ-3413A/B	3062
E8DZ-3A413-A	3102
F4CZ-3B437-A	3440
G-568-22-510B	3321
G-570-22-510A	3322
GO13-25-500	3176
GO13-25-600	3176
B002-25-500	3371
B002-25-600	3371
B003-25-400/D	3371
B003-25-600/D	3371
B005-25-400	3372
B005-25-600	3372
B004-25-400/D	3372
B004-25-600/D	3372
325400	3448
325641	3387
GEO	
7849841	3596
GMC	
326763	3450
7835070	3018
7841224	3029
7845070	3018
7849313	3221
26001362	3222
26003175	3222
26012744	3221
26020728	3221
26020731	3222
HONDA	
44011-S04-951	3486
44011-SK3-E10	3466
44014-QA4-000	3274
44305-SF1-910	3220
44305-SF1-911	3220
44305-SF1-912	3220
44305-SF1-913	3220

ALTERNATIVE TO OEM NO	GLO NO
44305-SF1-914	3220
44305-SF1-G10	3220
44305-SF1-G11	3220
44305-SF1-G12	3220
44305-SF1-G13	3220
S. 44511-SEO-406	3214
S. 44014-SD4-950	3263
S. 44302-657-020	3015
S. 44305-634-023	3015
S. 44305-634-033	3015
S. 44305-659-000	3015
S. 44305-671-023	3015
S. 44305-SH9-000	3211
S. 44305-SH9-003	3211
S. 44306-634-013	3015
S. 44306-657-023	3015
S. 44306-659-010	3015
S. 44306-671-003	3015
S. 44306-671-033	3015
S. 44306-671-880	3015
S. DX 44305-634-003	3556
S. DX 44305-634-013	3556
S. DX 44305-634-023	3556
S. DX 44305-634-033	3556
S. DX 44305-671-003	3556
S. DX 44305-671-023	3556
S. DX 44305-688-000	3082
S. DX 44305-688-020	3082
S. DX 44305-689-601	3556
S. DX 44305-692-003	3556
S. DX 44305-692-671	3060
S. DX 44305-SA5-000	3082
S. DX 44305-SA5-010	3082
S. DX 44305-SA5-020	3083
S. DX 44305-SA5-620	3083
S. DX 44305-SA5-622	3581
S. DX 44305-SA5-623	3581
S. DX 44305-SA5-640	3083
S. DX 44305-SA5-641	3083
S. DX 44305-SA5-970	3581
S. DX 44305-SA5-971	3581
S. DX 44305-SAO-003	3556
S. DX 44305-SB0-621	3083
S. DX 44305-SB0-622	3083
S. DX 44305-SB0-623	3083
S. DX 44305-SB0-624	3083
S. DX 44305-SB2-000	3080
S. DX 44305-SB2-010	3080
S. DX 44305-SB2-750	3052

ALTERNATIVE TO OEM NO	GLO NO
S. DX 44305-SB2-751	3052
S. DX 44305-SB2-960	3052
S. DX 44305-SB2-961	3052
S. DX 44305-SB2-982	3581
S. DX 44305-SBO-010	3581
S. DX 44305-SBO-020	3581
S. DX 44305-SBO-030	3581
S. DX 44305-SBO-030	3581
S. DX 44305-SBO-970	3581
S. DX 44305-SBO-971	3581
S. DX 44305-SD2-010	3581
S. DX 44305-SD2-020	3581
S. DX 44305-SD2-040	3581
S. DX 44305-SD2-961	3581
S. DX 44305-SD2-962	3581
S. DX 44305-SD2-963	3581
S. DX 44305-SD2-964	3581
S. DX 44305-SD2-965	3581
S. DX 44305-SD4-010	3163
S. DX 44305-SD4-020	3163
S. DX 44305-SD4-030	3163
S. DX 44305-SE0-000	3106
S. DX 44305-SE0-010	3106
S. DX 44305-SE0-020	3106
S. DX 44305-SE0-G01	3106
S. DX 44305-SE0-G02	3106
S. DX 44305-SE0-J00	3106
S. DX 44305-SE0-J01	3106
S. DX 44305-SE0-912	3581
S. DX 44305-SE0-922	3581
S. DX 44305-SE0-923	3581
S. DX 44305-SE0-924	3581
S. DX 44305-SE0-G11	3581
S. DX 44305-SE0-G21	3581
S. DX 44305-SE0-G22	3581
S. DX 44305-SE0-G24	3581
S. DX 44305-SE0-J20	3581
S. DX 44305-SE0-J21	3581
S. DX 44305-SE0-J22	3581
S. DX 44305-SF1-915	3180
S. DX 44305-SF1-975	3180
S. DX 44305-SF4-010	3080
S. DX 44305-SF4-020	3080
S. DX 44305-SF4-900	3080
S. DX 44305-SF4-901	3080
S. DX 44305-SF4-J21	3052
S. DX 44305-SF4-J22	3052
S. DX 44305-SF4-J23	3052
S. DX 44305-SF4-J40	3052

ALTERNATIVE TO OEM NO	GLO NO
S. DX 44305-SF4-J41	3052
S. DX 44305-SF4-J42	3052
S. DX 44305-SFO-621	3581
S. DX 44305-SFO-971	3581
S. DX 44305-SFO-972	3581
S. DX 44305-SH3-000	3080
S. DX 44305-SH3-010	3080
S. DX 44305-SH3-960	3106
S. DX 44305-SH3-970	3106
S. DX 44305-SH3-971	3106
S. DX 44305-SH3-980	3106
S. DX 44305-SH3-981	3106
S. DX 44305-SH3-A00	3106
S. DX 44305-SH3-A01	3106
S. DX 44305-SH3-A21	3080
S. DX 44305-SH3-G00	3106
S. DX 44305-SH3-G01	3106
S. DX 44305-SH3-G10	3106
S. DX 44305-SH3-G11	3106
S. DX 44305-SH3-G21	3581
S. DX 44305-SH3-G23	3581
S. DX 44305-SH3-G25	3581
S. DX 44305-SH3-J00	3581
S. DX 44305-SH3-J01	3581
S. DX 44305-SH3-J10	3581
S. DX 44305-SH9-000	3581
S. DX 44305-SH9-003	3581
S. DX 44305-SM4-010	3180
S. DX 44305-SM4-020	3180
S. DX 44305-SM4-040	3180
S. DX 44305-SM4-980	3180
S. DX 44305-SM4-981	3180
S. DX 44305-SM4-983	3180
S. DX 44305-SM4-984	3180
S. DX 44306-SD4-950	3163
S. DX 44306-SD4-951	3163
S. DX 44306-SD4-952	3163
S. SX 44305-SH3-961	3106
S. SX 44306-634-013	3556
S. SX 44306-657-000	3556
S. SX 44306-657-023	3556
S. SX 44306-659-000	3556
S. SX 44306-659-010	3556
S. SX 44306-671-003	3556
S. SX 44306-671-033	3556
S. SX 44306-688-000	3082
S. SX 44306-688-020	3082
S. SX 44306-689-601	3556
S. SX 44306-692-003	3556

ALTERNATIVE TO OEM NO	GLO NO
S. SX 44306-692-671	3060
S. SX 44306-SA5-000	3082
S. SX 44306-SA5-010	3082
S. SX 44306-SA5-020	3083
S. SX 44306-SA5-020	3083
S. SX 44306-SA5-611	3581
S. SX 44306-SA5-620	3083
S. SX 44306-SA5-622	3581
S. SX 44306-SA5-623	3581
S. SX 44306-SA5-640	3083
S. SX 44306-SA5-641	3083
S. SX 44306-SA5-660	3581
S. SX 44306-SA5-950	3083
S. SX 44306-SA5-951	3083
S. SX 44306-SA5-970	3581
S. SX 44306-SA5-971	3581
S. SX 44306-SAO-013	3556
S. SX 44306-SB0-621	3083
S. SX 44306-SB0-622	3083
S. SX 44306-SB0-624	3083
S. SX 44306-SB0-670	3083
S. SX 44306-SB0-671	3083
S. SX 44306-SB2-000	3080
S. SX 44306-SB2-750	3052
S. SX 44306-SB2-751	3052
S. SX 44306-SB2-960	3052
S. SX 44306-SB2-961	3052
S. SX 44306-SB2-982	3581
S. SX 44306-SBO-010	3581
S. SX 44306-SBO-020	3581
S. SX 44306-SBO-030	3581
S. SX 44306-SBO-040	3581
S. SX 44306-SBO-650	3581
S. SX 44306-SBO-651	3581
S. SX 44306-SBO-970	3581
S. SX 44306-SBO-971	3581
S. SX 44306-SD2-010	3581
S. SX 44306-SD2-020	3581
S. SX 44306-SD2-030	3581
S. SX 44306-SD2-900	3581
S. SX 44306-SD2-901	3581
S. SX 44306-SD2-903	3581
S. SX 44306-SD2-961	3581
S. SX 44306-SD2-962	3581
S. SX 44306-SD2-963	3581
S. SX 44306-SD2-964	3581
S. SX 44306-SD2-965	3581
S. SX 44306-SD4-010	3163
S. SX 44306-SD4-020	3163

ALTERNATIVE TO OEM NO	GLO NO
S. SX 44306-SD4-030	3163
S. SX 44306-SD4-950	3163
S. SX 44306-SD4-951	3163
S. SX 44306-SD4-952	3163
S. SX 44306-SE0-000	3106
S. SX 44306-SE0-010	3106
S. SX 44306-SE0-020	3106
S. SX 44306-SE0-980	3106
S. SX 44306-SE0-981	3106
S. SX 44306-SE0-982	3106
S. SX 44306-SE0-G01	3106
S. SX 44306-SE0-G02	3106
S. SX 44306-SE0-910	3581
S. SX 44306-SE0-911	3581
S. SX 44306-SE0-920	3581
S. SX 44306-SE0-921	3581
S. SX 44306-SE0-923	3581
S. SX 44306-SE0-G10	3581
S. SX 44306-SE0-G12	3581
S. SX 44306-SE0-G20	3581
S. SX 44306-SE0-G21	3581
S. SX 44306-SE0-G23	3581
S. SX 44306-SE0-J20	3581
S. SX 44306-SE0-J21	3581
S. SX 44306-SE0-J22	3581
S. SX 44306-SE0-J23	3581
S. SX 44306-SF1-916	3180
S. SX 44306-SF1-976	3180
S. SX 44306-SF1-J71	3180
S. SX 44306-SF4-001	3080
S. SX 44306-SF4-020	3080
S. SX 44306-SF4-J21	3052
S. SX 44306-SF4-J22	3052
S. SX 44306-SF4-J23	3052
S. SX 44306-SFO-621	3581
S. SX 44306-SFO-970	3581
S. SX 44306-SFO-971	3581
S. SX 44306-SFO-973	3581
S. SX 44306-SH3-000	3080
S. SX 44306-SH3-010	3080
S. SX 44306-SH3-960	3106
S. SX 44306-SH3-961	3106
S. SX 44306-SH3-970	3106
S. SX 44306-SH3-971	3106
S. SX 44306-SH3-980	3106
S. SX 44306-SH3-981	3106
S. SX 44306-SH3-A00	3106
S. SX 44306-SH3-A01	3106
S. SX 44306-SH3-A21	3080

ALTERNATIVE TO OEM NO	GLO NO
S. SX 44306-SH3-G00	3106
S. SX 44306-SH3-G01	3106
S. SX 44306-SH3-G10	3106
S. SX 44306-SH3-G22	3581
S. SX 44306-SH3-G24	3581
S. SX 44306-SH3-G26	3581
S. SX 44306-SH3-J00	3581
S. SX 44306-SH3-J01	3581
S. SX 44306-SH3-J11	3581
S. SX 44306-SH9-J00	3581
S. SX 44306-SH9-J01	3581
S. SX 44306-SM4-010	3180
S. SX 44306-SM4-020	3180
S. SX 44306-SM4-040	3180
S. SX 44306-SM4-980	3180
S. SX 44306-SM4-981	3180
S. SX 44306-SM4-983	3180
S. SX 44306-SM4-984	3180
S. SX44306-SB2-010	3080
S. SX44306-SH3-G11	3106
44010-SR3-020	3374
44011-SR3-020	3374
44010-SR3-902	3374
44011-SR3-901	3374
44010-SR3-952	3374
44011-SR3-952	3374
44010-SR3-040	3374
44011-SR3-040	3374
44010-SR3-903	3374
44011-SR3-903	3374
44010-ST7-900	3374
44011-ST7-900	3374
44305-SD5-013	3196
44306-SD5-013	3196
44305-SD5-003	3196
44306-SD5-003	3196
44305-SD5-901	3197
44010-SD5-901	3197
44306-SD5-J01	3197
44011-SD5-J01	3197
44306-SD5-901	3197
44011-SD5-901	3197
44014-SV4-950	3400
44010-SR3-040	3415
44305-SD3-003	3425
44305-SF1-970	3434
44430-SN7-315	3475
HYUNDAI	
49508-29C00	3454

ALTERNATIVE TO OEM NO	GLO NO
49508-29H00	3455
S. 49507-21000	3044
S. 49508-21000	3044
S. DX MB 176161	3044
S. DX MB 176865	3044
S. DX MB 176867	3044
S. DX MB 178865	3044
S. DX MB 297344	3044
S. DX MB 297346	3044
S. DX MB 297348	3044
S. DX MB 297353	3044
S. DX MB 297662	3044
S. DX MB 297678	3124
S. DX MB 297699	3124
S. DX MB 297874	3044
S. DX MB 526064	3044
S. DX MB 526067	3044
S. DX MB 526118	3044
S. DX MB 526444	3044
S. DX MB 526454	3044
S. DX MB 526473	3124
S. DX MB 526548	3044
S. DX MB 526582	3044
S. DX MB 526831	3124
S. DX MB 526854	3044
S. DX MB 526866	3044
S. DX MB 526898	3044
S. DX MB 526999	3044
S. DX MB 620770	3044
S. MB 297492	3217
S. SX MB 176160	3044
S. SX MB 176866	3044
S. SX MB 297148	3044
S. SX MB 297343	3044
S. SX MB 297345	3044
S. SX MB 297347	3044
S. SX MB 297661	3044
S. SX MB 297696	3124
S. SX MB 297696	3124
S. SX MB 525577	3044
S. SX MB 526063	3044
S. SX MB 526066	3044
S. SX MB 526117	3044
S. SX MB 526443	3044
S. SX MB 526453	3044
S. SX MB 526464	3217
S. SX MB 526531	3044
S. SX MB 526547	3044
S. SX MB 526581	3044

ALTERNATIVE TO OEM NO	GLO NO
S. SX MB 526829	3217
S. SX MB 526853	3044
S. SX MB 526865	3044
S. SX MB 526897	3044
S. SX MB 526999	3044
INNOCENTI	
4087120	3501
4247399	3501
4308412	3501
4308413	3501
4313087	3501
4328468	3501
4465504	3501
5944690	3501
5998706	3501
7656786	3504
27H7567	3009
ISUZU	
8-94467-664-0	3181
8-94364-332-0	3181
8-94467-671-0	3182
8-94467-669-0	3182
KIA	
B002-25-500	3371
B002-25-600	3371
B003-25-400/D	3371
B003-25-600/D	3371
LADA	
2108-2215012	3107
S. DX 2108-2215010	3107
S. SX 2108-2215011	3107
LANCIA	
4315132	4512
4390952	3504
4393155	3012
4393157	3012
4475837	3504
5929237	3706
5929240	3706
7373193	3012
7629457	3667
7631082	3168
7633434	3706
7656944	3706
7656949	3673
7659161	3168
7659169	3667
7659169	3667
7688157	3673

ALTERNATIVE TO OEM NO	GLO NO
7698632	3012
7698900	3706
7750300	3673
7770910	3251
9936769	4512
60605055	3673
60810018	3706
60811033	3673
82301373	3706
82333811	3706
82362521	3706
82362523	3706
82362524	3706
82362524	3706
82413699	3671
82443532	3671
82449123	3671
82466864	3673
82466864	3246
82466865	3245
82480859	3671
82486230	3673
82486230	3673
82486231	3706
82489521	3250
92601903	3667
7560070	3504
7577041	3504
82301373	3706
82333811	3706
82362523	3706
82428432	3706
82439756	3706
82440166	3706
9617408188 SX	3288
9617408288 DX	3288
9619947580 SX	3287
9619947680 DX	3287
S. SX/DX 11646.17047.01	3706
S. SX/DX 16400.17047.01	3706
MAZDA	
50257017	3331
105015	3228
G-568-22-510B	3321
G-570-22-510A	3322
GO13-25-500	3176
GO13-25-600	3176
S. DX F001-25-400A	3035
S. DX F001-25-400B	3035

ALTERNATIVE TO OEM NO	GLO NO
S. DX F003-25-400A	3035
S. DX F003-25-400B	3035
S. DX F004-25-500A	3144
S. DX F004-25-500B	3144
S. DX F004-25-500C	3144
S. DX F005-25-400A	3035
S. DX F005-25-400B	3035
S. DX F005-25-400C	3035
S. DX F013-25-400	3239
S. DX F023-25-400	3239
S. DX F024-25-400	3238
S. DX G001-25-500	3178
S. DX G001-25-500A	3178
S. DX G001-25-500B	3178
S. DX G002-25-500	3034
S. DX G002-25-500A	3034
S. DX G002-25-500B	3034
S. DX G005-25-500	3178
S. DX G006-25-500	3034
S. DX G011-25-500	3178
S. DX G012-25-500A	3034
S. DX G012-25-500B	3034
S. DX G022-25-500A	3034
S. DX G022-25-500B	3034
S. DX G024-25-500	3267
S. G001-25-500D	3178
S. G001-25-600E	3178
S. G012-22-510	3144
S. SX F001-25-600A	3035
S. SX F001-25-600B	3035
S. SX F003-25-600A	3035
S. SX F003-25-600B	3035
S. SX F004-25-600A	3144
S. SX F004-25-600B	3144
S. SX F004-25-600C	3144
S. SX F005-25-600A	3035
S. SX F005-25-600B	3035
S. SX F005-25-600C	3035
S. SX F007-25-600A	3035
S. SX F013-25-600	3239
S. SX F023-25-600	3239
S. SX F024-25-600	3238
S. SX G001-25-600	3178
S. SX G001-25-600A	3178
S. SX G001-25-600B	3178
S. SX G002-25-600	3034
S. SX G002-25-600A	3034
S. SX G002-25-600B	3034
S. SX G005-25-600	3178

ALTERNATIVE TO OEM NO	GLO NO
S. SX G006-25-600	3034
S. SX G011-25-600	3178
S. SX G012-25-600	3034
S. SX G022-25-600A	3034
S. SX G024-25-600	3267
F039-22-510B	3299
F039-25-610A	3299
B002-25-500	3371
B002-25-600	3371
B003-25-400/D	3371
B003-25-600/D	3371
B005-25-400	3372
B005-25-600	3372
B004-25-400/D	3372
B004-25-600/D	3372
M070-22-510	3470
MERCEDES-BENZ	
A6383340534	3453
000 330 00 36	3500
MERCURY (FORD USA)	
6069110	3062
81AG3A187AA	3062
E2GZ-3B413-A	3022
E3FZ-3B413-B	3023
E43Z-3B413-B	3078
E6DZ-3413A/B	3062
E8DZ-3A413-A	3102
S. DX F001-25-400A	3035
S. DX F001-25-400B	3035
S. DX F003-25-400A	3035
S. DX F003-25-400B	3035
S. DX F005-25-400A	3035
S. DX F005-25-400B	3035
S. DX F005-25-400C	3035
S. SX F001-25-600A	3035
S. SX F001-25-600B	3035
S. SX F003-25-600A	3035
S. SX F003-25-600B	3035
S. SX F005-25-600A	3035
S. SX F005-25-600B	3035
S. SX F005-25-600C	3035
S. SX F007-25-600A	3035
MITSUBISHI	
MB 525577	3458
MB 526558	3458
MB 620065	3452
MB 620178	3456
MB 620440	3452
MB 896316	3435

ALTERNATIVE TO OEM NO	GLO NO
S. 49507-21000	3044
S. 49508-21000	3044
S. DX MB 176161	3044
S. DX MB 176865	3044
S. DX MB 176867	3044
S. DX MB 178865	3044
S. DX MB 297344	3044
S. DX MB 297346	3044
S. DX MB 297348	3044
S. DX MB 297353	3044
S. DX MB 297385	3142
S. DX MB 297662	3044
S. DX MB 297678	3124
S. DX MB 297699	3124
S. DX MB 297874	3044
S. DX MB 526064	3044
S. DX MB 526067	3044
S. DX MB 526118	3044
S. DX MB 526444	3044
S. DX MB 526454	3044
S. DX MB 526455	3142
S. DX MB 526473	3124
S. DX MB 526533	3142
S. DX MB 526548	3044
S. DX MB 526582	3044
S. DX MB 526831	3124
S. DX MB 526854	3044
S. DX MB 526866	3044
S. DX MB 526898	3044
S. DX MB 526999	3044
S. DX MB 620770	3044
S. MB 297492	3217
S. MB 526453	3142
S. MB 526454	3142
S. MB 526544	3219
S. MB 526551-3	3219
S. SX MB 176160	3044
S. SX MB 176866	3044
S. SX MB 297148	3044
S. SX MB 297343	3044
S. SX MB 297345	3044
S. SX MB 297347	3044
S. SX MB 297376	3142
S. SX MB 297661	3142
S. SX MB 297661	3044
S. SX MB 297696	3124
S. SX MB 297696	3124
S. SX MB 525577	3044
S. SX MB 526063	3044

ALTERNATIVE TO OEM NO	GLO NO
S. SX MB 526066	3044
S. SX MB 526117	3044
S. SX MB 526353	3142
S. SX MB 526443	3044
S. SX MB 526453	3044
S. SX MB 526456	3142
S. SX MB 526464	3217
S. SX MB 526531	3044
S. SX MB 526547	3044
S. SX MB 526581	3044
S. SX MB 526829	3217
S. SX MB 526853	3044
S. SX MB 526865	3044
S. SX MB 526897	3044
S. SX MB 526999	3044
S. SX/DX MB 176872	3142
MB 837642	3416
NISSAN-DATSUN	
39204-01B28	3149
39210-A03G0	3108K
39210-X08R0	3489
39211-24B00	3150
39211-50Y00	3271
39211-60Y00	3268
39211-60Y10	3269
39211-64Y00	3270
39211-71J25	3148
39211-73J25	3146
S. 30205-13A25	3111
S. 39112-M7225	3045
S. 39113-M7275	3045
S. 39202-13A25	3111
S. 40010-M7226	3045
S. 40011-M5626	3045
S. DX 39100-01A00	3111
S. DX 39100-01A01	3111
S. DX 39100-01E02	3098
S. DX 39100-02A00	3111
S. DX 39100-02E02	3098
S. DX 39100-03A01	3111
S. DX 39100-05E02	3233
S. DX 39100-10E02	3233
S. DX 39100-11A00	3686
S. DX 39100-11A10	3686
S. DX 39100-11A20	3686
S. DX 39100-11M00	3686
S. DX 39100-11M05	3686
S. DX 39100-12A00	3686
S. DX 39100-12A10	3686

ALTERNATIVE TO OEM NO	GLO NO
S. DX 39100-12A20	3686
S. DX 39100-13A00	3686
S. DX 39100-13A01	3686
S. DX 39100-13A10	3686
S. DX 39100-16E00	3233
S. DX 39100-16E02	3233
S. DX 39100-50A00	3110
S. DX 39100-50A10	3110
S. DX 39100-55A00	3143
S. DX 39100-61E00	3147
S. DX 39100-62E00	3147
S. DX 39100-80E05	3147
S. DX 39100-D4600	3147
S. DX 39100-M7270	3045
S. SX 39101-01A00	3111
S. SX 39101-01A01	3111
S. SX 39101-01E02	3098
S. SX 39101-02A00	3111
S. SX 39101-02E02	3098
S. SX 39101-03A00	3111
S. SX 39101-05E02	3233
S. SX 39101-10E02	3233
S. SX 39101-11A10	3686
S. SX 39101-11A20	3686
S. SX 39101-11M00	3686
S. SX 39101-11M05	3686
S. SX 39101-12A10	3686
S. SX 39101-12A20	3686
S. SX 39101-13A10	3686
S. SX 39101-16E00	3233
S. SX 39101-16E02	3233
S. SX 39101-50A00	3110
S. SX 39101-50A10	3110
S. SX 39101-55A00	3143
S. SX 39101-61E00	3147
S. SX 39101-80E05	3147
S. SX 39101-D4600	3147
S. SX 39101-M7270	3045
S. SX 39211-32R00	3147
S. SX 39211-50A00	3110
S. SX 39211-55A00	3143
S. SX 39301-10A01	3686
S. SX 39301-11A00	3686
S. SX 39301-12A00	3686
S. SX 39301-13A00	3686
S. SX 39301-13A01	3686
335712	3367
326582	3368
326905	3451

ALTERNATIVE TO OEM NO	GLO NO
S.326461	3368
S.326462	3368
39100-60A10	3384
39100-65A00	3384
39100-65A10	3384
39100-85E00	3377
39101-50Y01	3271
39101-52Y00	3271
39101-53Y00	3271
39101-60A10	3384
39101-65A10	3384
39101-85E00	3377
39210-F4125	3469
39211-4F425	3391
39211-4F125	3392
39211-4F126	3393
39211-72J25	3422
39211-73J27	3423
39211-71J26	3424
39100-51Y10	3426
OLDSMOBILE (GENERAL MOTORS)	
7831589	3037
7832259	3017
7835070	3018
7835075	3037
7837075	3026
7842037	3026
7843919	3026
7844793	3017
7845005	3037
7845009	3017
7845024	3026
7845070	3018
26000690	3133
26008329	3133
26008330	3132
26011523	3130
26017183	3134
26017184	3135
26017201	3134
26017202	3135
26020958	3133
26020959	3132
26020961	3134
26020962	3135
26026732	3130
26026736	3131
26030481	3132

ALTERNATIVE TO OEM NO	GLO NO
OPEL	
374002	3476
374003	3478
374049	3538
374061	3538
374066	3039
374092	3068
374126	3127
374147	3118
374175	3126
374176	3100
374213	3360
374218	3359
374262	3479
374263	3360
374346	3480
26032411	3359
26060700	3480
90125875	3538
90147008	3538
90157131	3039
90235271	3127K
90304775	3118
90334947	3126
90334948	3100
90345303	3360
90498406	3360
90538427	3476
90538595	3478
S. DX 07837457	3068
S. DX 374078	3068
S. SX 07837456	3068
S. SX 374077	3068
PEUGEOT	
2108 2215011	3112
3272-E3	3462
3272-F6	3462
3272-S5	3474
3272-S6	3481
3272.60	3413
3273-L1	3462
3273N2	3273
95598210	3090
95643689	3240
95646292	3076
95653009	3244
95653010	3243
9567582280	3465
9617408188 SX	3288

ALTERNATIVE TO OEM NO	GLO NO
9617408288 DX	3288
9619947580 SX	3287
9619947680 DX	3287
S SX 327485	3069
S. (L) 3272.E2	3308
S. (R) 3273.L4	3308
S. 95604719	3069
S. DX 327210	3112
S. DX 327360	3076
S. DX 327362	3076
S. DX 3273C7	3076
S. DX 95606803	3076
S. DX 95606804	3076
S. SX 327318	3069
S. SX 327323	3069
S. SX 327360	3076
S. SX 327379	3112
S. SX 327483	3069
S. SX 327486	3069
S. SX 95606802	3076
PLYMOUTH (CHRYSLER)	
4186691	3521
4186890	3025
4205852	3521
4367001	3066
4384702	3117
4384734	3117
4641019	3128
4641021	3159
4641329	3136
4641330	3137
4670012	3160
4670013	3128
5212606	3521
5212712	3027
5212789	3027
5212830	3065
5212856	3042
5212869	3040
52112591	3024
PONTIAC (GENERAL MOTORS)	
7832259	3017
7837075	3026
7842037	3026
7843919	3026
7844793	3017
7845009	3017
7845024	3026
7845332	3063

ALTERNATIVE TO OEM NO	GLO NO
26000690	3133
26003052	3154
26008329	3133
26008330	3132
26011523	3130
26020958	3133
26020959	3132
26026732	3130
26026736	3131
26030481	3132
PROTON	
MB 297344	3326
MB 896742	3325
MB 937965	3323
MR 111854	3328
MR 111856	3329
S. 49507-21000	3044
S. 49508-21000	3044
RENAULT	
1349697	3095
1498775	3094
1498918	3095
3601 13KT-X	3330
7701-349-938	3300
7701-349-955	3303
7701-349-992	3306
S. SX/DX 7701351172	3094
S. SX/DX 7701351607	3094
2-99-341X-2	3382
341-149	3383
7701351948	3497
7701352471	3493
7701469363	3407
7702096437	3366
ROVER	
03CGV1053	3104
17H8600	3006
27H7567	3009
BAU 4414	3164
BAU 4851	3093
BAU 5466	3091
BAU 5467	3092
GCV 1105	3006
GCV 1075	3411
GCV 1088	3488
GCV 1118	3484
GCV 1119	3477
SAAB	
892172	3232

ALTERNATIVE TO OEM NO	GLO NO
892173	3232
4000659	3338
4000642	3223
4002911	3339
4103255	3230
4103263	3231
8921728	3232
8942633	3189
8963571	3339
8990574	3189
9102880	3099
9103672	3224
SEAT	
4087120	3501
4247399	3501
4308412	3501
4308413	3501
4313087	3501
4328468	3501
4393155	3012
4393157	3012
4465504	3501
4465504	3501
5944689	3501
5944690	3501
5944690	3501
5959385	3501
5998706	3501
5998706	3501
7373193	3012
7698632	3012
191407311	3548
191.598.099	3548K
171407311K	3548
171498099C	3548K
191407311C	3547
191407311H	3548
191407311L	3547
191498099	3548K
191498099A	3547K
191498099F	3548
1H0 407 311 C	3548K
1H0.498.099A	3340K
321.498.099E	3548K
321.498.099F	3548K
357.498.099E	3340K
811.498.099F	3548K
893.407.311	3547
SE025141514A	3501

ALTERNATIVE TO OEM NO	GLO NO
SE025141514B	3501
SE141141514A	3501
SEO22141915A	3504
SKODA	
S. DX 115420217	3119
S. DX 441.0.7265-170.6	3119
S. SX 115420214	3119
S. SX 441.0.7265-158.6	3119
SUBARU	
28021-AA051	3294
28021-AA052	3294
28021-AA053	3294
28021-AA150	3294
28021-AA151	3294
28021-AA152	3294
S. SX/DX 23221-GA232	3190
S. SX/DX 23221-GA233	3190
S. SX/DX 23221-GA242	3054
S. SX/DX 23221-GA243	3054
S. SX/DX 23221-GA372	3191
S. SX/DX 23221-GA373	3191
S. SX/DX 23221-GA592	3191
S. SX/DX 23221-GA593	3191
S. SX/DX 23291-GA191	3191
S. SX/DX 28021-AA011	3229
S. SX/DX 28021-AA013	3229
S. SX/DX 28021-AA012	3229
S. SX/DX 28021-AA161	3229
S. SX/DX 28021-AA021	3192
S. SX/DX 28021-AA022	3192
S. SX/DX 28021-AA031	3192
S. SX/DX 28021-AA032	3192
S. SX/DX 28021-AA033	3192
S. SX/DX 28021-AA053	3192
S. SX/DX 28021-AA130	3192
S. SX/DX 28021-AA131	3192
S. SX/DX 28021-AA132	3192
S. SX/DX 28021-AA150	3192
S. SX/DX 28021-AA151	3192
S. SX/DX 28021-AA152	3192
S. SX/DX 7232-21055	3028
S. SX/DX 7232-21392	3070
S. SX/DX 7232-91001	3070
S. SX/DX 7232-91003	3070
S. SX/DX 7232-91013	3028
7232-91140	3259
7232-91130	3259
7232-91301	3259
7232-91311	3259

ALTERNATIVE TO OEM NO	GLO NO
7232-51001	3259
7232-51011	3259
28091-KA420	3198
28091-KA410	3198
28021-KA540	3198
28021-KA550	3198
28021-KA500	3198
28021-KA510	3198
28021-KA280	3198
28021-KA290	3198
28021-KA560	3198
28091-KA480	3198
28021-KA440	3199
28091-KA440	3199
28021-KA450	3199
28091-KA430	3199
28021-KA570	3199
28091-KA510	3199
28021-KA580	3199
28091-KA500	3199
7232-20041	3390
SUZUKI	
44105-78-B00-000	3236
S. 44101-82020	3532
S. 44101-82021	3532
S. 44101-82313	3532
S. 44101-82611	3532
S. 44101-86041	3532
S. 44102-82020	3532
S. 44102-82021	3532
S. 44102-82313	3532
S. 44102-82611	3532
S. 44102-86041	3532
S. DX 44101-78010	3532
S. DX 44101-78011	3532
S. DX 44101-78012	3532
S. SX 44102-78010	3532
S. SX 44102-78011	3532
S. SX 44102-78012	3532
44101-60GB0	3444
44101-60G61	3442
44102-60G22	3441
44101-63B10	3281
44102-63B10	3281
44101-63B20	3281
44102-63B20	3281
44101-60B30	3281
44102-60B30	3281
44101-70B32	3281

ALTERNATIVE TO OEM NO	GLO NO
44102-70B32	3281
44101-71C10	3289
44101-64B10	3417
TOYOTA	
43405-60015	3463
43405-60016	3463
43405-60030	3464
43405-60040	3463
43405-60050	3464
43410-10101	3439
43410-20240	3295
43410-20241	3295
43420-20190	3295
43420-20191	3295
43460-19156	3296
S. DX 43410-12020	3049
S. DX 43410-12021	3049
S. DX 43410-12040	3050
S. DX 43410-12050	3049
S. DX 43410-12060	3049
S. DX 43410-12070	3050
S. DX 43410-12080	3049
S. DX 43410-12090	3050
S. DX 43410-12130	3049
S. DX 43410-12140	3050
S. DX 43410-12150	3050
S. DX 43410-12170	3050
S. DX 43410-20010	3050
S. DX 43410-20020	3050
S. DX 43410-20031	3050
S. DX 43410-20040	3050
S. DX 43410-20060	3235
S. DX 43410-20070	3235
S. DX 43410-20100	3050
S. DX 43410-32010	3050
S. DX 43410-32011	3050
S. DX 43410-32020	3050
S. DX 43410-32021	3050
S. DX 43410-32022	3050
S. DX 43410-32030	3050
S. DX 43410-32040	3050
S. DX 43410-32060	3050
S. SX 43420-12020	3049
S. SX 43420-12021	3049
S. SX 43420-12030	3049
S. SX 43420-12040	3050
S. SX 43420-12050	3049
S. SX 43420-12060	3049
S. SX 43420-12070	3050

ALTERNATIVE TO OEM NO	GLO NO
S. SX 43420-12080	3049
S. SX 43420-12090	3049
S. SX 43420-12100	3050
S. SX 43420-12110	3050
S. SX 43420-12140	3050
S. SX 43420-20010	3050
S. SX 43420-20020	3050
S. SX 43420-20040	3235
S. SX 43420-20050	3235
S. SX 43420-20060	3050
S. SX 43420-20070	3050
S. SX 43420-20120	3050
S. SX 43420-32010	3050
S. SX 43420-32011	3050
S. SX 43420-32030	3050
S. SX 43420-32040	3050
43460-19086	3218
43410-10020	3218
43420-10020	3218
43410-10060	3218
43420-10060	3218
43410-10050	3218
43410-10090	3218
43420-10090	3218
43410-10130	3218
43420-10130	3218
302860	3394
43420-12330	3399
VAUXHALL	
374002	3476
374003	3478
374049	3538
374061	3538
374066	3039
374092	3068
374126	3127
374147	3118
374175	3126
374176	3100
374346	3480
26060700	3480
90125875	3538
90147008	3538
90157131	3039
90235271	3127K
90304775	3118
90334947	3126
90334948	3100
90538427	3476

ALTERNATIVE TO OEM NO	GLO NO
90538595	3478
S. DX 07837457	3068
S. DX 374078	3068
S. SX 07837456	3068
S. SX 374077	3068
VOLKSWAGEN	
113501331	4511
113598101	4511K
150498099	3432
150498099A	3432K
171407271	7003
171407271B	7001
171407271E	7001
171407271G	7003
171407271R	7003
171407271T	7003
171407272	7004
171407272AF	7008
171407272B	7004
171407272E	7002
171407272E	7004
171407272F	7004
171407272G	7004
171407272M	7004
171407272N	7004
171407272N	7006
171407272P	7004
171407311	3505
171407311D	3505
171407311E	3089
171407311J	3548
171407311K	3548
171407311L	3548
171407311P	3547
171407331H	4511
171407331K	4511
171407331L	4005
171498099	3505K
171498099C	3548K
171498103C	4511K
171498103D	4005K
191407271	7005
191407271A	7007
191407271B	7007
191407271C	7007
191407271N	7005
191407271P	7007
191407271Q	7007
191407271R	7007

ALTERNATIVE TO OEM NO	GLO NO
191407272	7010
191407272A	7010
191407272AA	7010
191407272AC	7010
191407272AP	7008
191407272AT	7004
191407311	3548
191407311C	3547
191407311H	3548
191407311L	3547
191407331	4048
191498099	3548K
191498099A	3547K
191498099F	3548
191.598.099	3548K
1H0 407 311 C	3548K
1H0407331B	4048
1H0.498.099A	3340K
S.SX 1J0.407.271F	3432
S.DX 1J0.407.271F	3432
211501331B	4047
211598101	4047K
251501203	7013
251501203B	7015
251501203D	7015
251598101	4047K
301501203-1	4047
321407271AG	7009
321407271N	7009
321407331	4511
321407331D	4048
321498099	3505K
321498099B	3548K
321498099C	3547K
321.498.099E	3548K
321.498.099F	3548K
321498103	4511K
321498103B	4048K
357498099E	3340K
431407331-DIES	4051
431407331G	4051
431498103C	4051K
6NO498099	3307
701.407.321D	3369
701.407.321E	3370
701.407.331B	4369
701.498.099B	3369
701.498.099C	3370
701.498.103A	4369

NUOVE APPLICAZIONI PER CODICI GIA' A CATALOGO NEW APPLICATIONS FOR PART NUMBERS IN THE CATALOGUE

AUDI 100, 100 Avant	3200
CHRYSLER Saratoga	3158
FIAT Palio, Palio Weekend	3363
HOLDEN (AUSTRALIA) Commodore	4061
KIA Sephia	3238
MAZDA Capella	3322
MAZDA MX-3	3238
MAZDA MX-3	3409
MAZDA MX-6	3176
MAZDA MX-6, 626	3322
MAZDA Protege	3409
MERCEDES-BENZ Viano	3453
OPEL (EUROPE) Kadett	3538
OPEL (EUROPE) Kadett, Vectra	3100
OPEL (EUROPE) Kadett, Vectra	3127
OPEL (EUROPE) Vectra	3360
OPEL (EUROPE) Vectra	3126
OPEL (EUROPE) Kadett	4038
OPEL (EUROPE) Kadett, Vectra	4039
PONTIAC (GENERAL MOTORS) 6000, Trans Sport	3026
PONTIAC (GENERAL MOTORS) Lemans, Optima (Canada)	3039
SUZUKI Alto	3532
SUZUKI Swift	3281
SUZUKI Swift	3532

CODICI CONSOLIDATI

PART NUMBERS FOR CONSOLIDATIONS

Abbiamo studiato per Voi e i Vostri clienti un modo per risparmiare soldi e spazio nel Vostro magazzino: l'unificazione dei giunti!

Siamo ora orgogliosi di proporVi alcuni nuovi riferimenti che consolidano due o più giunti.

Per qualche mese sulle scatole dei nuovi riferimenti unificati stamperemo anche i codici vecchi, in modo da facilitare il collegamento.

We have studied for you and your customers a way to save money and space in your warehouse: the unification of c.v. joints!

We are now very proud to offer you the following new items which are a consolidation of two or more different joints.

For some months the boxes with the new part numbers will be marked with both the new and the old numbers, to help you in identifying them in your stock.

Nuovi Codici New Part Numbers	Vecchi Codici Old Part Numbers	Applicazioni Applications
3238	3297	Mazda
3239	3298	Mazda
3302	3312	Audi
3311	3341	Audi
3322	3282	Ford (USA), Mazda
3336	3362	Fiat
3501	3001-3007	Autobianchi, Fiat, Innocenti, Seat, Zastava
3504	3004-3071-3166	Fiat, Lancia, Innocenti, Seat, Zastava
3505	3005-3011-3319	Audi, Volkswagen, Volkswagen (Brazil)
3521	3021-3113	Chrysler, Dodge, Plymouth
3532	3032-3193	Suzuki
3538	3038-3361	Opel, Vauxall, GMB Brazil
3547	3047-3086-3334	Audi, Ford (Brazil), Seat, Volkswagen
3548	3013-3036-3048-3327	Audi, Ford (Brazil), Seat, Volkswagen, Volkswagen (Brazil)
3556	3016-3056	Honda
3581	3081-3101	Honda
3596	3096-3194	Chevrolet, Geo, Toyota
3667	3072-3167	Fiat, Lancia
3671	3141-3171	Fiat, Lancia
3673	3170-3173	Fiat, Lancia
3675	3030-3175	Ford Europe, Ford Brazil
3686	3046-3186	Nissan Datsun
3706	3058-3088-3169-3206	Alfa Romeo, Fiat, Lancia
3749	3249-3276	Alfa Romeo, Lancia
4511	4010-4011	Audi, Fiat, Seat, Volkswagen
4512	4012-4023-4226	Alfa Romeo, Fiat, Ford, Lancia, Moskvich

TABELLA DI CONVERSIONE VECCHI → NUOVI

CONVERTION TABLE OLD → NEW

VECCHIO CODICE - OLD PART NUMBER	NUOVO CODICE - NEW PART NUMBER
3001	3501
3004	3504
3005	3505
3007	3501
3011	3505
3013	3548
3016	3556
3021	3521
3030	3675
3032	3532
3036	3548
3038	3538
3046	3686
3047	3547
3048	3548
3056	3556
3058	3706
3071	3504
3072	3667
3081	3581
3086	3547
3088	3706
3096	3596
3101	3581
3113	3521
3141	3671
3166	3504
3167	3667
3169	3706
3170	3673
3171	3671
3173	3673
3175	3675
3186	3686
3193	3532
3194	3596
3206	3706
3249	3749
3276	3749
3282	3322
3297	3238
3298	3239
3312	3302
3319	3505
3327	3548
3334	3547
3341	3311
3361	3538
3362	3336

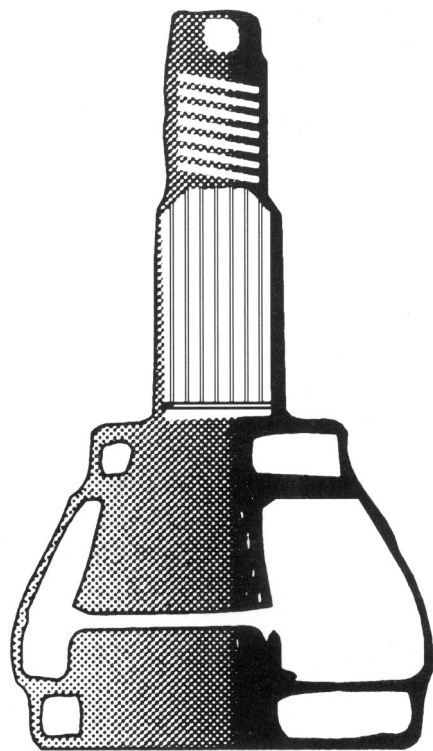

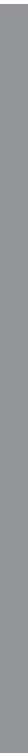

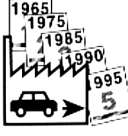
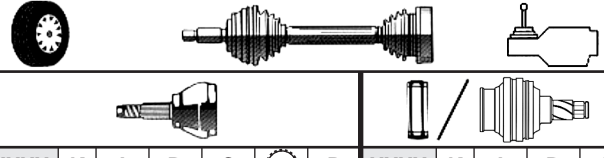

					CHASSIS →	→ CHASSIS						G L O N . 									
							XXXX	K	A	B	C	ABS	P	XXXX	K	A	B	C			
ACURA → HONDA																					
AIXAM																					
400							3115	K	18	18	42		E	4015	K	18	18	62			
400							3116	K	18	18	42		E	4015	K	18	18	62			
ALFA ROMEO																					
33																					
1.2			5 261 499	06-83	04-88		3162	K	28	22	55		E	4121	K		24	94			
1.2		5 261 500		04-88			3121	K	28	24	55		E	4121	K		24	94			
1.3			5 261 499	06-83	04-88		3162	K	28	22	55		E	4121	K		24	94			
1.3		5 261 500		04-88			3121	K	28	24	55		E	4121	K		24	94			
1.35	55/58 kW (75-79 HP)		5 261 499	06-83	04-88		3162	K	28	22	55		E	4121	K		24	94			
1.35	55/58 kW (75-79 HP)	5 261 500		04-88			3121	K	28	24	55		E	4121	K		24	94			
1.5	62/63 kW (84-85 HP)			06-83	04-88		3121	K	28	24	55		E	4121	K		24	94			
1.5 Ti	77 kW (105 HP)			04-88			3121	K	28	24	55		E	4121	K		24	94			
1.7 16V ABS	95/101 kW			01-90										4121	K		24	94			
1.7 16V, 4WD FWD ABS	95/97 kW (129-132 HP)			01-90	94		3471	K	25	25	52	44	I								
1.7 i.e.				10-86			3121	K	28	24	55		E	4121	K		24	94			
1.7 QUADR. VERDE				10-86			3121	K	28	24	55		E	4121	K		24	94			
1.7, SPORTWAGON	77/87 kW (105-118 HP)			10-86			3121	K	28	24	55		E	4121	K		24	94			
1.8 TURBO DIESEL	54 kW (74 HP)			10-86			3121	K	28	24	55		E	4121	K		24	94			
33 4x4																					
1.5 FWD	77 kW (105 HP)			07-86	12-89		3121	K	28	24	55		E	4121	K		24	94			
1.7 16V ABS	95/101 kW			01-90	09-94									4121	K		24	94			
1.7 FWD	77/87 kW (105-118 HP)			10-86	12-89									4121	K		24	94			
TT				01-88			3215	K	25	24	52		E								
75																					
1.6	77/85 kW			05-85	12-92		4121	K		24	94			4121	K		24	94			
1.8	88/90 kW			05-85	12-92		4121	K		24	94			4121	K		24	94			
2.0 TURBO DIESEL	70 kW			05-85	12-92		4121	K		24	94			4121	K		24	94			
2.0, 2.0 T.S.	104/107/109 kW			01-87	12-92		4121	K		24	94			4121	K		24	94			
2.4 TURBO DIESEL				05-85	12-92		4121	K		24	94			4121	K		24	94			
90																					
1.8	89 kW			09-84	12-88		4121	K		24	94			4121	K		24	94			
2.0	94 kW			09-84	12-88		4121	K		24	94			4121	K		24	94			
2.0 V6	97 kW			09-84	12-88		4121	K		24	94			4121	K		24	94			
2.5 V6	110/115 kW			09-84	12-88		4121	K		24	94			4121	K		24	94			



CHASSIS ↑

→ CHASSIS



G L O N .

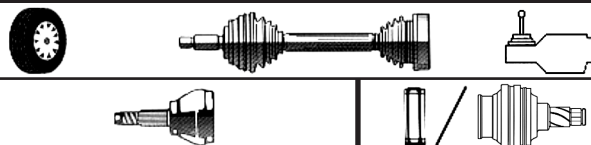



XXXX	K	A	B	C	ABS	P	XXXX	K	A	B	C
------	---	---	---	---	-----	---	------	---	---	---	---

ALFA ROMEO

145-146																	
1.3				09-94		3706	K	25	25	52		I					
1.3 ABS				09-94		3673	K	25	25	52	44	I					
1.4 16V T-SPARK	76 kW (103 HP)		0146134	97		3344	K	25	25	52		E					
1.4 16V T-SPARK ABS	76 kW (103 HP)			97		3345	K	25	25	52	44	E					
1.6				09-94		3706	K	25	25	52		I					
1.6 ABS				09-94		3673	K	25	25	52	44	I					
1.6 16V T-SPARK	88 kW (120 HP)		0146134	97		3344	K	25	25	52		E					
1.6 16V T-SPARK ABS	88 kW (120 HP)			97		3345	K	25	25	52	44	E					
1.7 16V				09-94		3706	K	25	25	52		I					
1.7 16V ABS				09-94		3673	K	25	25	52	44	I					
1.8 16V T-SPARK	103 kW (140 HP)		0146134	97		3344	K	25	25	52		E					
1.8 16V T-SPARK ABS	103 kW (140 HP)			97		3345	K	25	25	52	44	E					
1.9 TURBO DIESEL				09-94		3706	K	25	25	52		I					
1.9 TURBO DIESEL	66 kW (90 HP)		0146134	97		3344	K	25	25	52		E					
1.9 TURBO DIESEL ABS	66 kW (90 HP)			97		3345	K	25	25	52	44	E					
2.0 i.e. 16V (BRASIL)				09-94		3706	K	25	25	52		I					
2.0 i.e. 16V (ITALY) ABS				09-94		3673	K	25	25	52	44	I					
155																	
1.6 T-SPARK	88 kW (120 HP)		0166649	05-96		3706	K	25	25	52		I	4345	K		25	100
1.6 T-SPARK	88 kW (120 HP)	0166650		05-96		3344	K	25	25	52		E	4345	K		25	100
1.6 T-SPARK ABS	88 kW (120 HP)		0166649	05-96		3673	K	25	25	52	44	I	4345	K		25	100
1.6 T-SPARK ABS	88 kW (120 HP)	0166650		05-96		3345	K	25	25	52	44	E	4345	K		25	100
155 (M.T.)																	
1.6i 16V TWIN SPARK ABS	88 kW (120 HP)			07-96		3252	K	25	28	56	44	E	4512	K		25	100
1.75	83/85 kW (113-115 HP)			01-92		3706	K	25	25	52		I	4512	K		25	100
1.8	93/95 kW (126-129 HP)			01-92		3706	K	25	25	52		I	4512	K		25	100
1.9 TURBO DIESEL	66/68 kW			01-92		3706	K	25	25	52		I	4512	K		25	100
2.0 TWIN SPARK	104/105 kW (141-143 HP)	T 610 4158		01-92		3706	K	25	25	52		I	4512	K		25	100
2.0 16V TURBO Q4 ABS (4x4)	137/140 kW (187-191 HP)	Assale Anter.		01-92		3252	K	25	28	56	44	E	4512	K		25	100
2.5 TURBO DIESEL SUPER ABS	92 kW (125 HP)			04-93		3252	K	25	28	56	44	E	4512	K		25	100
2.5 V6 ABS	121/122 kW (187-191 HP)			01-92		3252	K	25	28	56	44	E	4512	K		25	100
TT ABS				01-92		3673	K	25	25	52	44	I	4512	K		25	100
156																	
1,6 TS						3438	K	25	25	59		E					
2.5 V6 24V	140 kW (190 HP)			97		3468	K	25	28	59		E	4345	K		25	100
TT (EXC. 2.5 V6)				97		3438	K	25	25	59		E	4345	K		25	100
164 (A.T.)																	
3.0 V6	132/135 kW (179-184 HP)			03-89	09-92	3248	K	27	28	56		E	4051	K		28	108
3.0 V6 ABS	132/135 kW (179-184 HP)			07-87	09-92	3749	K	27	28	56	90	E	4051	K		28	108
3.0 V6 ABS	132/135 kW (179-184 HP)			10-92	12-95	3250	K	27	28	56	44	E	4051	K		28	108
164 (M.T.)																	
2.0	105/109 kW (143-148 HP)		T 610 4158	07-87		3706	K	25	25	52		I	4512	K		25	100
2.0 T.S. (H3)	106 kW			09-92		3673	K	25	25	52	44	I	4512	K		25	100
2.0 TURBO	129 kW (175 HP)		T 610 4158	07-87		3706	K	25	25	52		I	4512	K		25	100
2.0 TWIN SPARK TURBO				01-87		3706	K	25	25	52		I	4512	K		25	100

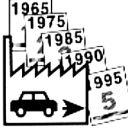

	CHASSIS →	→ CHASSIS		G L O N .											
															
				XXXX	K	A	B	C	ABS	P	XXXX	K	A	B	C
ALFA ROMEO															
2.0i V6 TURBO			01-87		3706	K	25	25	52		I	4512	K	25	100
2.5 TURBO DIESEL 84/86 kW (114-117 HP)			07-87	09-92	3248	K	27	28	56		E	4051	K	28	108
2.5 TURBO DIESEL ABS 84/86 kW (114-117 HP)		T 610 3325	07-87	12-89	3749	K	27	28	56	90	E	4051	K	28	108
2.5 TURBO DIESEL ABS 84/86 kW (114-117 HP)	T 610 3326		01-90	09-92	3749	K	27	28	56	90	E	4051	K	28	108
3.0 V6 132/135 kW (179-184 HP)			07-87	09-92	3248	K	27	28	56		E	4051	K	28	108
3.0 V6 ABS 132/135 kW (179-184 HP)			07-87	09-92	3749	K	27	28	56	90	E	4051	K	28	108
164 SUPER F.L. (A.T.)															
2.5 TURBO DIESEL ABS 92 kW (125 HP)			09-92	12-95	3250	K	27	28	56	44	E	4051	K	28	108
2.5 V6 ABS			09-92	12-95	3250	K	27	28	56	44	E	4051	K	28	108
3.0 V6 -24V ABS 132/169 kW (180-230 HP)			09-92	12-95	3250	K	27	28	56	44	E	4051	K	28	108
164 SUPER F.L. (M.T.)															
2.0 V6 TURBO ABS 148/151 kW (201-205 HP)			09-92	12-95	3250	K	27	28	56	44	E	4051	K	28	108
2.5 TURBO DIESEL ABS 92 kW (125 HP)			09-92	12-95	3250	K	27	28	56	44	E	4051	K	28	108
2.5 V6 ABS			09-92	12-95	3250	K	27	28	56	44	E	4051	K	28	108
3.0 V6-24V / Q4 ABS 132/169 kW (180-230 HP)			09-92	12-95	3250	K	27	28	56	44	E	4051	K	28	108
166															
2.0 T-SPARK 16V ABS 114 kW (155 HP)			09-98		3483	K	27	25	59		E	4345	K	25	100
2.0 V6 12V TURBO A.T. 151 kW (205 HP)			09-98		3485	K	27	28	59		E				
2.0 V6 12V TURBO M.T. (inner DX) 151 kW (205 HP)			09-98		3485	K	27	28	59		E	4051	K	28	108
2.0 V6 12V TURBO M.T. (inner SX) 151 kW (205 HP)			09-98		3485	K	27	28	59		E	4485	K	28	108
2.4 JTD A.T./M.T. 100 kW (136 HP)			09-98		3485	K	27	28	59		E				
2.5 V6 24V A.T. 140 kW (190 HP)			09-98		3485	K	27	28	59		E				
2.5 V6 24V M.T. (inner DX) 140 kW (190 HP)			09-98		3485	K	27	28	59		E	4051	K	28	108
2.5 V6 24V M.T. (inner SX) 140 kW (190 HP)			09-98		3485	K	27	28	59		E	4485	K	28	108
3.0 V6 24V A.T. 166 kW (226 HP)			09-98		3485	K	27	28	59		E				
3.0 V6 24V M.T. (inner DX) 166 kW (226 HP)			09-98		3485	K	27	28	59		E	4051	K	28	108
3.0 V6 24V M.T. (inner SX) 166 kW (226 HP)			09-98		3485	K	27	28	59		E	4485	K	28	108
1750 (M.T.)															
105,48	83 kW		03-68	07-75	4121	K		24	94			4121	K	24	94
ALFA SUD															
1.2	46/50 kW		01-72	12-83								4121	K	24	94
1.3	50/58 kW		01-72	12-83								4121	K	24	94
1.3 Ti	64 kW		01-80	12-84								4121	K	24	94
1.5	61/70 kW		01-72	12-83								4121	K	24	94
1.5 Ti	77 kW		01-80	12-84								4121	K	24	94
ALFA SUD SPRINT															
1.3	64 kW		01-80	12-84								4121	K	24	94
1.3			01-85	12-86	3121	K	28	24	55		E				
1.5	77 kW		01-80	12-84								4121	K	24	94
1.5	70/77 kW (105-115 HP)		01-83	12-86	3121	K	28	24	55		E				
1.7			01-87		3121	K	28	24	55		E				
QUADRIFOGLIO			01-87		3121	K	28	24	55		E				
ALFETTA															
1.6 GT, GTV	80 kW		01-72	12-84	4121	K		24	94			4121	K	24	94
1.8 GT, GTV	85/89 kW		01-72	12-84	4121	K		24	94			4121	K	24	94
2.0 TD	60 kW		10-79	03-83	4121	K		24	94			4121	K	24	94



CHASSIS ↑

→ CHASSIS

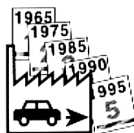

G L O N .







XXXX	K	A	B	C	ABS	P	XXXX	K	A	B	C
------	---	---	---	---	-----	---	------	---	---	---	---

ALFA ROMEO

2.0 GT, GTV	96 kW		01-72	12-84	4121	K		24	94			4121	K		24	94	
2.0 NUOVA GTV	95 kW				4121	K		24	94			4121	K		24	94	
ALFETTA AMERICANA																	
2.0			01-78	12-84	4121	K		24	94			4121	K		24	94	
ALFETTA BERLINA																	
1.6				12-84	4121	K		24	94			4121	K		24	94	
1.8				12-84	4121	K		24	94			4121	K		24	94	
2.0			01-72	12-84	4121	K		24	94			4121	K		24	94	
ARNA																	
1.2	44/50 kW (60-68 HP)		06-83	09-87	3162	K	28	22	55		E	4121	K		24	94	
1.3			06-83	09-87	3162	K	28	22	55		E	4121	K		24	94	
1,35	58 kW (79 HP)		5 261 499	06-83	09-87	3162	K	28	22	55		E	4121	K		24	94
1,35		5 261 499		09-87	04-88	3121	K	28	24	55		E	4121	K		24	94
1.35 TC			06-83	09-87	3162	K	28	22	55		E	4121	K		24	94	
1.35 Ti	63 kW (85 HP)		06-83	04-88	3121	K	28	24	55		E	4121	K		24	94	
1.5, 1.5i			06-83	09-87	3121	K	28	24	55		E	4121	K		24	94	
GIULIETTA																	
1,3			01-78	12-85	4121	K		24	94			4121	K		24	94	
1,6			01-78	12-85	4121	K		24	94			4121	K		24	94	
1,8			01-78	12-85	4121	K		24	94			4121	K		24	94	
2.0			01-78	12-85	4121	K		24	94			4121	K		24	94	
2.0 TURBO DIESEL			06-83	12-93	4121	K		24	94			4121	K		24	94	
GTV																	
1.8 16V T-SPARK ABS	106 kW (144 HP)		05-98									4345	K		25	100	
2.0 16V T-SPARK ABS M.T.	114 kW (155 HP)		05-98									4345	K		25	100	
2.0 i. 16V TWIN SPARK ABS			05-95		3673	K	25	25	52	44	I						
SPIDER																	
1.8 16V T-SPARK ABS	106 kW (144 HP)		05-95									4345	K		25	100	
2.0 16V T-SPARK ABS M.T.	114 kW (155 HP)		05-95									4345	K		25	100	
2.0 i. 16V TWIN SPARK ABS			05-95		3673	K	25	25	52	44	I						
2.0 i. V6 TURBO ABS			05-95		3252	K	25	28	56	44	E						
3.0 V6	141 kW		06-95		3252	K	25	28	56	44	E						
SPRINT																	
1.3	63 kW		01-83		3121	K	28	24	55		E	4121	K		24	94	
1.5	70/77 kW		01-83	12-86	3121	K	28	24	55		E	4121	K		24	94	
1.7	77/87 kW		01-87		3121	K	28	24	55		E	4121	K		24	94	



	CHASSIS →	← CHASSIS		G L O N .										
														
				XXXX	K	A	B	C	ABS	P	XXXX	K	A	B

AMERICAN MOTORS

EAGLE																			
4 CYL				01-80	12-87	3031		27	23	55,9		I							
6 CYL				01-80	12-83	3031		27	23	55,9		I							
6 CYL				01-84	12-87	3085		27	23	56		I							
TT				01-80	12-80	3031		27	23	55,9		I							
TT				01-86	12-88														
JEEP CHEROKEE																			
TT				01-84	12-87	3097	K	27	32	71		I							
JEEP WAGONEER																			
TT				01-84	12-87	3097	K	27	32	71		I							

AUDI

50																			
1.1-1.3	37/44 kW (50-60 HP)	865 1500 001	868 2499 999	08-74	07-78	3089	K	20	25	45,5		I	4005	K		33	91,8		
80 - 80 AVANT - 90 (A.T.)																			
1.6	51/55/63/81 kW (70-75-85-110 HP)	824 2072 774	828 2200 000	11-73	07-78	3505	K	22	30	51		E	4511	K		33	94		
1.6	48/63 kW (65-85 HP)	81-B-020 001	81-E-220 000	08-78	08-84	3548	K	22	30	51		I	4511	K		33	94		
1.6	48/63 kW (65-85 HP)	819 2100 001	81-B-020 000	09-78	08-80	3505	K	22	30	51		E	4511	K		33	94		
1.6	54/55 kW (73-75 HP)	81-F-000 001	81-H-220 000	06-84	08-86	3548	K	22	30	51		I	4511	K		33	94		
1.6	75 kW (102 HP)	8A-M-000 001	8A-N-200 000	08-90	12-91	3138	K	33	30	53		I							
1.6 ABS	75 kW (102 HP)	8A-M-000 001	8A-N-200 000	08-90	12-91	3139	K	33	30	53	45	I							
1.8	64/65/66/68 kW (87-92 HP)	81-D-079 180	81-H-299 000	01-83	03-87	3548	K	22	30	51		I	4511	K		33	94		
1.8 ABS, 1.8 S ABS	55/65/66 kW (75-88-90 HP)	89-H-300 001	89-J-373 598	09-86	01-90	3304	K	22	30	51	96	E	4048	K		33	100		
1.8 ABS, 1.8 S ABS	55/65/66 kW (75-88-90 HP)	89-J-373 599	8A-N-200 000	10-86	12-91	3139	K	33	30	53	45	I							
1.8, 1.8 S	55/65/66 kW (75-88-90 HP)	89-H-300 001	89-J-373 598	09-86	10-91	3548	K	22	30	51		I	4048	K		33	100		
1.8, 1.8 S	55/65/66 kW (75-88-90 HP)	89-J-373 599	8A-N-200 000	04-88	12-91	3138	K	33	30	53		I							
1.9	83 kW (113 HP)	89-H-300 001	89-J-373 598	09-86	07-88	3547	K	22	30	51		I	4048	K		33	100		
1.9	83 kW (113 HP)	89-J-373 599	8A-N-200 000	04-88	07-88	3138	K	33	30	53		I							
1.9 ABS	83 kW (113 HP)	89-H-300 001	89-J-373 598	09-86	04-88	3290	K	22	30	51	96	I	4048	K		33	100		
1.9 ABS	83 kW (113 HP)	89-J-373 599	8A-N-200 000	04-88	07-88	3139	K	33	30	53	45	I							
1.9, 1.9 CD 5S	85 kW (115 HP)	81-D-077 974	81-D-250 000	08-81	07-83	3547	K	22	30	51		I	4048	K		33	100		
1.9, 1.9 CD 5S	85 kW (115 HP)	81-C-000 001	81-D-077 973	08-81	07-83	3548	K	22	30	51		I	4511	K		33	94		
2.0	81/85 kW (110-115 HP)	89-H-300 001	89-J-373 598	09-86	04-88	3547	K	22	30	51		I	4048	K		33	100		
2.0 4-GEAR	66/85 kW (90-115 HP)	8C-N-000 001	8C-P-300 000	09-91	01-96	3138	K	33	30	53		I							
2.0 5S/5E	81/85 kW (110-115 HP)	81-D-250 000	81-G-220 000	08-83	08-86	3547	K	22	30	51		I	4048	K		33	100		
2.0 ABS	85 kW (115 HP)	89-H-450 420	89-J-373 598	04-87	04-88	3290	K	22	30	51	96	I	4048	K		33	100		
2.0 ABS	66/85 kW	8C-N-000 001	8C-N-360 000	09-91	08-92	3139	K	33	30	53	45	I							



CHASSIS ↑

→ CHASSIS

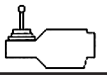
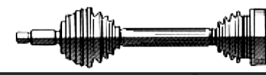



**G L O N .**

XXXX	K	A	B	C	ABS	P	XXXX	K	A	B	C
------	---	---	---	---	-----	---	------	---	---	---	---

AUDI

2.0 ABS 4-GEAR	66/85 kW (90-115 HP)	8C-N-000 001	8C-P-300 000	09-91	01-96	3139	K	33	30	53	45	I					
2.0 ABS, 2.0 E ABS	82/83/85 kW (111-113-115 HP)	8A-K-000 001	8A-N-010 640	08-88	10-91	3139	K	33	30	53	45	I					
2.0, 2.0 E	82/83/85 kW (111-113-115 HP)	8A-K-000 001	8A-N-010 640	08-88	10-91	3138	K	33	30	53		I					
2.2	77/85 kW (105-115 HP)	81-B-000 001	81-D-077 973	08-80	12-82	3548	K	22	30	51		I	4511	K		33	94
2.2	77/85 kW (105-115 HP)	81-D-077 974	81-E-007 059	12-82	08-83	3547	K	22	30	51		I	4048	K		33	100
2.3	85 kW (115 HP)	81-F-094 728	81-H-299 000	01-85	03-87	3547	K	22	30	51		I	4048	K		33	100
2.3	100 kW (136 HP)	81-F-040 647	81-H-299 000	10-84	03-87	3212	K	22	25	51		E	4051	K		28	108
2.3	100 kW (136 HP)	89-H-000 001	89-J-373 598	04-87	03-88	3547	K	22	30	51		I	4051	K		28	108
2.3 3-GEAR	100 kW (136 HP)	89-J-373 599	8A-N-200 000	04-88	12-91	3138	K	33	30	53		I					
2.3 4 GEAR	100 kW (136 HP)	8A-L-000 000	8A-N-200 000	01-89	12-91	3138	K	33	30	53		I					
2.3 ABS	100 kW (136 HP)	81-F-000 001	81-H-299 000	06-84	03-87	3234	K	22	25	50,8	96	I	4051	K		28	108
2.3 ABS	85 kW	81-F-094 728	81-H-299 000	01-85	03-87	3234	K	22	25	50,8	96	I	4051	K		28	108
2.3 ABS	100 kW (136 HP)	81-H-000 001	89-J-373 598	09-86	04-88	3290	K	22	30	51	96	I	4051	K		28	108
2.3 ABS 3-GEAR	100 kW (136 HP)	89-J-373 599	8A-N-200 000	04-88	12-91	3139	K	33	30	53	45	I					
2.3 ABS 4-GEAR	100 kW (136 HP)	8A-L-000 000	8A-N-200 000	01-89	12-91	3139	K	33	30	53	45	I					
2.3 AIR COND.	100 kW (136 HP)	89-H-429 200	89-K-420 000	04-87	07-89	3138	K	33	30	53		I	4051	K		28	108
2.6 V6 ABS	106/110 kW (144-150 HP)	8C-N-237 404	8C-P-300 000	07-92	12-94	3302	K	38	27	59,5	45	I					
2.8 V6 ABS, E ABS	128 kW (174 HP)	8C-N-000 001	8C-P-300 000	09-91	12-94	3302	K	38	27	59,5	45	I					
80 - 80 AVANT - 90 (M.T.)																	
1.3	40/44 kW (54-60 HP)	823 2000 001	81-B-020 000	05-72	08-80	3505	K	22	30	51		E	4511	K		33	94
1.3	40/44 kW (54-60 HP)	81-B-020-001	81-H-299 000	08-80	03-87	3548	K	22	30	51		I	4511	K		33	94
1.5	55/63 kW (75-85 HP)	823 2198 265	825 2110 429	05-72	08-75	3505	K	22	30	51		E	4511	K		33	94
1.6	40/81 kW (54-110 HP)	819 2100 001	81-B-020 000	08-78	08-80	3505	K	22	30	51		E	4511	K		33	94
1.6	48/63 kW (65-85 HP)	81-B-020 001	81-H-299 000	08-80	03-87	3548	K	22	30	51		I	4511	K		33	94
1.6	51/55 kW (70-75 HP)	89-H-300 001	89-J-373 598	09-86	09-91	3548	K	22	30	51		I	4511	K		33	94
1.6	51/55 kW (70-75 HP)	89-J-373 599	8A-N-200 000	04-88	12-91	3103	K	33	30	53		I					
1.6	73 kW (100 HP)	8C-N-170 008	8C-R-061 858	08-90	10-93	3138	K	33	30	53		I	4051	K		28	108
1.6	75 kW (102 HP)	8A-M-063 598	8A-N-200 000	08-90	12-91	3138	K	33	30	53		I					
1.6	51 kW (70 HP)	8C-N-086 135	8C-P-300 000	01-92	07-94	3138	K	33	30	53		I	4511	K		33	94
1.6 ABS	51/55 kW (70-75 HP)	89-H-300 001	89-J-373 598	09-86	09-91	3304	K	22	30	51	96	E	4511	K		33	94
1.6 ABS	51/55 kW (70-75 HP)	89-J-373 599	8A-N-200 000	04-88	12-91	3140	K	33	30	53	45	I					
1.6 ABS	75 kW (102 HP)	8A-M-063 598	8A-N-200 000	08-90	12-91	3139	K	33	30	53	45	I					
1.6 ABS	51 kW (70 HP)	8C-N-110 685	8C-P-300 000	01-92	07-94	3139	K	33	30	53	45	I					
1.6 ABS	73 kW (100 HP)	8C-N-170 008	8C-R-300 000	01-92	07-94	3139	K	33	30	53	45	I	4051	K		28	108
1.6, 1.6 GLE	51/81 kW (70-110 HP)	823 2198 265	828 2200 000	09-73	06-82	3505	K	22	30	51		E	4511	K		33	94
1.8	65/66/68 kW (88-90-92 HP)	81-D-079 180	81-H-299 000	01-83	03-87	3548	K	22	30	51		I	4511	K		33	94
1.8	82 kW (112 HP)	89-H-300 001	89-J-373 598	09-86	04-88	3547	K	22	30	51		I	4048	K		33	100
1.8 ABS, 1.8 E ABS	82 kW (112 HP)	89-H-300 001	89-J-373 598	06-86	08-91	3290	K	22	30	51	96	I	4048	K		33	100
1.8 ABS, 1.8 E ABS	82 kW (112 HP)	89-J-373 599	8A-N-200 000	04-88	12-91	3139	K	33	30	53	45	I					
1.8 ABS, 1.8 S ABS	55/65/66 kW (75-88-90 HP)	89-H-300 001	89-J-373 598	09-86	04-90	3304	K	22	30	51	96	E	4511	K		33	94
1.8 ABS, 1.8 S ABS	55/65/66 kW (75-88-90 HP)	89-J-373 599	8A-N-200 000	10-86	12-91	3140	K	33	30	53	45	I					
1.8, 1.8 E	82 kW (112 HP)	89-J-373 599	8A-N-200 000	06-86	12-91	3138	K	33	30	53		I					
1.8, 1.8 S	55/65/66 kW (75-88-90 HP)	89-H-300 001	89-J-373 598	09-86	04-90	3548	K	22	30	51		I	4511	K		33	94
1.8, 1.8 S	55/65/66 kW (75-88-90 HP)	89-J-373 599	8A-N-200 000	04-88	12-91	3103	K	33	30	53		I					
1.9	85 kW (115 HP)	89-H-300 001	89-J-373 598	09-86	04-88	3547	K	22	30	51		I	4048	K		33	100
1.9	83 kW (113 HP)	89-J-373 599	8A-N-200 000	04-88	07-88	3138	K	33	30	53		I					



	CHASSIS →	→ CHASSIS		G L O N .									
													
				XXXX	K	A	B	C	ABS	P	XXXX	K	A

AUDI

1.9 ABS	83 kW (113 HP)	89-H-300 001	89-J-373 598	09-86	07-88	3290	K	22	30	51	96	I	4048	K		33	100
1.9 ABS	83 kW (113 HP)	89-J-373 599	8A-N-200 000	04-88	07-88	3139	K	33	30	53	45	I					
1.9, 1.9 CD 5S	85 kW (115 HP)	81-C-000 001	81-D-077 973	08-81	07-83	3548	K	22	30	51		I	4511	K		33	94
1.9, 1.9 CD 5S	85 kW (115 HP)	81-D-077 974	81-D-250 000	08-81	07-83	3547	K	22	30	51		I	4048	K		33	100
2.0	81/85 kW (110 -115 HP)	81-D-250 000	81-H-299 000	08-83	03-87	3547	K	22	30	51		I	4048	K		33	100
2.0	118 kW (160 HP)	8A-K-000 001	8A-N-200 000	08-88	12-91	3138	K	33	30	53		I	4051	K		28	108
2.0	101/103 kW (137-140 HP)	8A-L-202 350	8C-P-300 000	03-90	07-94	3138	K	33	30	53		I	4051	K		28	108
2.0	66/85 kW (90-115 HP)	8C-0-041 926	8C-P-300 000	11-91	07-94	3138	K	33	30	53		I					
2.0 ABS	85 kW (115 HP)	89-H-450 420	89-J-373 598	04-87	04-88	3290	K	22	30	51	96	I	4048	K		33	100
2.0 ABS	85 kW (115 HP)	89-H-450 420	89-J-373 598	04-87	04-88	3290	K	22	30	51	96	I	4048	K		33	100
2.0 ABS	118 kW (160 HP)	8A-K-000 001	8A-N-200 000	08-88	12-91	3139	K	33	30	53	45	I	4051	K		28	108
2.0 ABS	101/103 kW (137-140 HP)	8A-L-202 350	8C-P-300 000	03-90	07-94	3139	K	33	30	53	45	I	4051	K		28	108
2.0 ABS	66/85 kW (90-115 HP)	8C-0-041 926	8C-P-300 000	09-91	07-94	3139	K	33	30	53	45	I					
2.0 ABS AIR COND.	85 kW (115 HP)	89-J-373 599	8A-N-200 000	04-88	12-91	3139	K	33	30	53	45	I					
2.0 ABS, 2.0 E ABS	83/85 kW (113-115 HP)	89-J-373 599	8C-P-300 000	04-88	07-94	3139	K	33	30	53	45	I					
2.0 AIR COND.	85 kW (115 HP)	89-H-450 420	8A-N-200 000	04-87	12-91	3138	K	33	30	53		I					
2.0, 2.0 E	82/83/85 kW (111-113-115 HP)	89-J-373 599	8C-P-300 000	04-88	07-94	3138	K	33	30	53		I					
2.2	79/85 kW (107-115 HP)	81-B-000 001	81-D-077 973	08-80	12-82	3548	K	22	30	51		I	4511	K		33	94
2.2	79/85 kW (107-115 HP)	81-D-077 974	81-E-007 059	12-82	08-83	3547	K	22	30	51		I	4048	K		33	100
2.3	100 kW	81-F-040 647	81-H-299 000	10-84	03-87	3212	K	22	25	51		E	4051	K		28	108
2.3	85 kW (115 HP)	81-F-094 728	81-H-299 00	01-85	03-87	3547	K	22	30	51		I	4048	K		33	100
2.3	100 kW	89-H-429 200	89-J-373 598	04-87	03-88	3547	K	22	30	51		I	4051	K		28	108
2.3 ABS	100 kW	81-F-000 001	81-H-299 000	06-84	03-87	3234	K	22	25	50,8	96	I	4051	K		28	108
2.3 ABS	100 kW	89-H-429 200	89-J-373 598	04-87	04-88	3290	K	22	30	51	96	I	4051	K		28	108
2.3 ABS	125 kW (170 HP)	89-K-000 001	8A-N-200 000	08-88	12-91	3302	K	38	27	59,5	45	I	4051	K		28	108
2.3 ABS AIR COND.	100 kW (136 HP)	89-H-429 200	89-J-373 598	04-87	04-88	3290	K	22	30	51	96	I	4051	K		28	108
2.3 ABS AIR COND.	100 kW (136 HP)	89-J-373 599	89-K-420 000	04-88	07-89	3139	K	33	30	53	45	I	4051	K		28	108
2.3 ABS, 2.3 E ABS	98/100 kW (133-136 HP)	89-J-373 599		04-88	12-94	3139	K	33	30	53	45	I	4051	K		28	108
2.3 AIR COND.	100 kW (136 HP)	89-H-429 200	89-J-373 598	04-87	04-88	3138	K	33	30	53		I	4051	K		28	108
2.3, 2.3 E	98/100 kW (133-136 HP)	89-J-373 599		04-88	12-94	3138	K	33	30	53		I	4051	K		28	108
2.6 V6 ABS	106/110 kW (144-150 HP)	8C-N-237 404	8C-P-300 000	07-92	12-94	3302	K	38	27	59,5	45	I					
2.8 V6 ABS, E ABS	128 kW (174 HP)	8C-N-000 001	8C-P-300 000	09-91	12-94	3302	K	38	27	59,5	45	I					
80 DIESEL - 80 AVANT DIESEL - 90 DIESEL (A.T.)																	
1.6 D	40 kW (54 HP)	81-B-000 001	81-B-020 000	08-80	09-80	3505	K	22	30	51		E	4511	K		33	94
1.6 D	40 kW (54 HP)	81-B-020 001	81-H-299 000	09-80	08-91	3548	K	22	30	51		I	4511	K		33	94
1.6 TURBO DIESEL	51 kW (70 HP)	81*-C-117 462	81-H-299 000	08-81	03-87	3548	K	22	30	51		I	4511	K		33	94
1.6 TURBO DIESEL	59 kW (80 HP)	8A-L-000 001	8A-N-200 000	08-86	12-91	3138	K	33	30	53		I					
1.6 TURBO DIESEL ABS	59 kW (80 HP)	8A-L-000 001	8A-N-200 000	08-86	12-91	3139	K	33	30	53	45	I					
1.9 D	55 kW (75 HP)	8C-N-041 926	8C-N-360 001	11-91	07-94	3138	K	33	30	53		I					
1.9 D ABS	55 kW (75 HP)	8C-N-041 926	8C-P-300 000	11-91	07-94	3139	K	33	30	53	45	I					
80 DIESEL - 80 AVANT DIESEL - 90 DIESEL (M.T.)																	
1.6 D	40 kW (54 HP)	81-B-000 001	81-B-020 000	08-80	09-80	3505	K	22	30	51		E	4511	K		33	94
1.6 D	40 kW (54 HP)	81-B-020 001	89-J-373 598	09-80	08-91	3548	K	22	30	51		I	4511	K		33	94
1.6 D	40 kW (54 HP)	89-J-373 599	89-K-520 000	09-86	08-91	3103	K	33	30	53		I					
1.6 TURBO DIESEL	51 kW (70 HP)	81-C-117 462	89-J-373 598	08-81	04-88	3548	K	22	30	51		I	4511	K		33	94
1.6 TURBO DIESEL	59 kW (80 HP)	89-J-373 599	89-N-200 000	08-89	12-91	3103	K	33	30	53		I					



CHASSIS ↑

→ CHASSIS



G L O N .

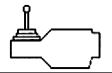
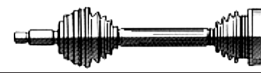







XXXX	K	A	B	C	ABS	P	XXXX	K	A	B	C
------	---	---	---	---	-----	---	------	---	---	---	---

AUDI

1.9 D	48/50 kW (65-68 HP)	8A-L-000 001	8A-N-200 000	08-89	12-91	3103	K	33	30	53		I						
1.9 D	66 kW (90 HP)	8C-N-066 274	8C-P-300 000	11-91	07-94	3138	K	33	30	53		I						
1.9 D ABS	48/50 kW (65-68 HP)	8A-L-000 001	8A-N-200 000	08-89	12-91	3140	K	33	30	53	45	I						
1.9 TURBO DIESEL	55 kW (75 HP)	8C-N-041 926	8C-P-300 000	11-91	07-94	3138	K	33	30	53		I						
1.9 TURBO DIESEL ABS	55 kW (75 HP)	8C-N-041 926	8C-P-300 000	11-91	07-94	3139	K	33	30	53	45	I						
1.9 TURBO DIESEL ABS	66 kW (90 HP)	8C-N-066 274	8C-P-300 000	11-91	07-94	3139	K	33	30	53	45	I						
80 - 80 AVANT QUATTRO - 90 QUATTRO FWD (M.T.)																		
1.8 ABS, 1.8 QUATTRO	65/66/82/83 kW (88-90-111-113 HP)	89-H-300 001	89-J-351 000	08-86	09-91	3290	K	22	30	51	96	I	4048	K		33	100	
1.8 ABS, 1.8 QUATTRO	65/66/82/83 kW (88-90-111-113 HP)	89-H-351 001	89-H-200 000	09-86	09-91	3139	K	33	30	53	45	I	4048	K		33	100	
1.8, 1.8 QUATTRO	65/66/82/83 kW (88-90-111-113 HP)	89-H-351 000	89-J-351 000	08-86	09-91	3547	K	22	30	51		I	4048	K		33	100	
2.0	118 kW (160 HP)	89-J-261272	89-J-351 000	01-88	03-88	3547	K	22	30	51		I	4048	K		33	100	
2.0 ABS	118 kW (160HP)	89-J-261 272	89-J-351 000	01-88	03-88	3290	K	22	30	51	96	I	4048	K		33	100	
2.0 ABS	(113-160-107-140HP)	89-H-351 001		01-88		3139	K	33	30	53	45	I	4048	K		33	100	
2.0 ABS	83/118 kW (107-140 HP)	89-N-140 001		03-92		3311	K	38	30	59,6	45	E	4048	K		33	100	
2.2 ABS	169 kW (230 HP)	8C-P-180 797		03-88		3302	K	38	27	59,5	45	I	4051	K		28	108	
2.3	100 kW (136 HP)	89-H-300 001	89-J-351 000	09-86	03-88	3547	K	22	30	51		I	4048	K		33	100	
2.3 AIR COND.	100 kW (136 HP)	89-H-450 000	89-J-351 000	03-87	03-88	3138	K	33	30	53		I	4048	K		33	100	
2.3 ABS	100 kW (136 HP)	89-H-450 000	89-J-351 000	03-87	03-88								4048	K		33	100	
2.3 ABS	(113-133-160 HP)	89-H-351001		03-88		3139	K	33	30	53	45	I	4048	K		33	100	
2.3 ABS	125 kW (170 HP)	89-H-401 412	89-N-200 000	06-88	09-91	3311	K	38	30	59,6	45	E	4048	K		33	100	
2.6 ABS	102/110 kW (139-150 HP)	8C-N-140 001		03-92		3311	K	38	30	59,6	45	E	4048	K		33	100	
2.8 ABS	128 kW (174 HP)	8C-N-140 001		03-92		3311	K	38	30	59,6	45	E	4048	K		33	100	
TT				08-82	07-86	3547	K	22	30	51		I	4048	K		33	100	
TT		89-J-260 000	89-J-260 000	08-86	12-87								4048	K		33	100	
TT ABS			89-J-260 000	08-82	07-86								4048	K		33	100	
TT ABS		89-J-260 001		01-88		3139	K	33	30	53	45	I	4048	K		33	100	
TT ABS		89-J-400 001		05-88		3140	K	33	30	53	45	I	4511	K		33	94	
80 - 80 AVANT QUATTRO - 90 QUATTRO RWD (M.T.)																		
1.8 ABS	66/83 kW (90-113 HP)	89-J-351 000	89-N-200 000	03-88	09-91	3140	K	33	30	53	45	I	4511	K		33	94	
2.0 ABS	83 kW (113 HP)	89-J-351 000	89-N-200 000	03-88	09-91	3140	K	33	30	53	45	I	4511	K		33	94	
2.0 ABS	118 kW (160 HP)	89-J-351 000	8A-N-200 000	03-88	09-91	3139	K	33	30	53	45	I	4048	K		33	100	
2.0 ABS	103 kW (140 HP)	8A-L-202 351	8A-N-200 000	03-90	09-91	3139	K	33	30	53	45	I	4048	K		33	100	
2.0 ABS (AVANT)	101/103 kW (137-140 HP)	8C-N-140 001		02-93		3292	K	38	25	59,6	45	E	4283	K		33	100	
2.0 ABS (LIMOUS.)	79/103 kW (107-140 HP)	8C-N-000 001	8C-P-300 000	09-91	07-93	3140	K	33	30	53	45	I	4511	K		33	94	
2.0 ABS (LIMOUS.)	79/103 kW (107-140 HP)	8C-R-000 001		07-93									4048	K		33	100	
2.2 ABS (LIMOUS.)	169 kW (230 HP)	8C-P-180 797		02-93		3292	K	38	25	59,6	45	E	4051	K		28	108	
2.3 20V ABS		89-J-400-001		01-89	12-91								4005	K		33	91,8	
2.3 ABS	100 kW (136 HP)	89-J-351 000	8A-L-360 000	04-87	07-90	3139	K	33	30	53	45	I	4511	K		33	94	
2.3 ABS	125 kW (170 HP)	89-J-401 413	8A-N-200 000	06-88	09-91	3139	K	33	30	53	45	I	4511	K		33	94	
2.3 ABS	100 kW (136 HP)	8A-L-360 001	8A-N-200 000	07-90	09-91	3140	K	33	30	53	45	I	4511	K		33	94	
2.3 ABS (AVANT))	98 kW (133 HP)	8C-N-140 001		02-93		3292	K	38	25	59,6	45	E	4283	K		33	100	
2.3 ABS (LIMOUS.)				01-88		3202	K	33	30	53	96	I	4511	K		33	94	
2.3 ABS (LIMOUS.)	98 kW (133 HP)	8C-N-000 001	8C-P-300 000	07-90	07-93	3140	K	33	30	53	45	I	4511	K		33	94	
2.3 ABS (LIMOUS.)	98 kW (126 HP)	8C-R-000 001		07-93									4048	K		33	100	
2.6 ABS (AVANT))	102/110 kW (139-150 HP)	8C-N-140 001		02-93		3292	K	38	25	59,6	45	E	4283	K		33	100	
2.6 ABS (LIMOUS.)	102/110 kW (139-150 HP)	8C-R-000 001		07-93									4048	K		33	100	



	CHASSIS →	→ CHASSIS		G L O N .  											
															
				XXXX	K	A	B	C	ABS	P	XXXX	K	A	B	C

AUDI

2.8 ABS (AVANT)	128 kW (174 HP)	8C-N-140 001		02-93		3292	K	38	25	59,6	45	E	4283	K		33	100
2.8 ABS (LIMOUS.)	128 kW (174 HP)	8C-R-000 001		07-93									4048	K		33	100
4-CYL.		89-J-350000	89-J-400 000	04-85	04-88	3073	K	26	25	56,5		E	4511	K		33	94
4-CYL. (2.3 L) ABS				01-89	12-91	3201	K	26	25	56,5	45	E	4511	K		33	94
4-CYL. ABS		89-J-350000	89-J-400 000	04-85	04-88	3283	K	26	25	56,5	96	E	4511	K		33	94
5-CYL.		89-J-350000	89-J-400 000	04-85	04-88	3073	K	26	25	56,5		E	4283	K		33	100
5-CYL. ABS		89-J-350000	89-J-400 000	04-85	04-88	3283	K	26	25	56,5	96	E	4283	K		33	100
TT				08-82	03-85	3301	K	26	28	56,4		E	4051	K		28	108
TT ABS				08-82	03-85	3313	K	26	28	56,6	96	E	4051	K		28	108
100 - 100 AVANT (A.T.)																	
1.6	63 kW (85 HP)	437 2007 746	43-C-090 315	08-76	07-82	3073	K	26	25	56,5		E	4511	K		33	94
1.8	74 kW (100 HP)	51 000 088	61 077 763	08-74	08-76	3073	K	26	25	56,5		E	4511	K		33	94
1.8	55 kW (75 HP)	44-D-000 001	44-G-300 000	08-82	07-86	3073	K	26	25	56,5		E	4511	K		33	94
1.8	65/66 kW (88-90 HP)	44-D-090 541	44-M-050 000	03-83	12-90	3073	K	26	25	56,5		E	4283	K		33	100
1.8 ABS	65/66 kW (88-90 HP)	44-F-000 001	44-J- 200 099	08-84	12-87	3283	K	26	25	56,5	96	E	4283	K		33	100
1.8 ABS	65/66 kW (88-90 HP)	44-J-200 100	44-M-050 000	01-88	12-90	3292	K	38	25	59,6	45	E	4283	K		33	100
1.8 ABS	65/66 kW (88-90 HP)	44-J-200100	44-M-050000	03-83	11-90	3201	K	26	25	56,5	45	E					
1.9	82 kW (112 HP)	51 000 088	61 077 763	08-74	08-76	3073	K	26	25	56,5		E					
2.0	77/85 kW (105-115 HP)	437 2000 001	438 2300 000	06-76	07-78	3073	K	26	25	56,5		E					
2.0	83/85 kW (113-115 HP)	43-A-078 194	44-M-050 000	08-86	12-90	3073	K	26	25	56,5		E	4051	K		28	108
2.0	83/85 kW (113-115 HP)	4A-M-000 001	4A-R-120 000	12-90	07-94	3293	K	38	30	59,4		E					
2.0 ABS	83/85 kW (113-115 HP)	44-F-000 001	44-J-200 099	08-86	12-87	3283	K	26	25	56,5	96	E	4051	K		28	108
2.0 ABS	83/85 kW (113-115 HP)	44-J-200 100	44-M-050 000	01-88	12-90								4051	K		28	108
2.0 ABS	85 kW (116 HP)			01-88	11-90	3201	K	26	25	56,5	45	E	4051	K		28	108
2.0 ABS	83/85 kW (112-115 HP)	4A-M-000 001	4A-R-120 000	12-90	07-94	3311	K	38	30	59,6	45	E					
2.0 DIESEL ABS	51 kW (69 HP)	44-J-200100	44-K-300000	08-82	07-88	3201	K	26	25	56,5	45	E	4051	K		28	108
2.2	85/100 kW (115-136 HP)	437 2000 001	43-A-078 193	06-76	11-79	3073	K	26	25	56,5		E					
2.2	85/100 kW (115-136 HP)	43-A-078 194	44-E-300 000	11-79	07-84	3073	K	26	25	56,5		E	4051	K		28	108
2.2 ABS 3-SPEED	100/101 kW (136-137 HP)	44-J-200100	44-K-300000	84	11-90	3201	K	26	25	56,5	45	E	4051	K		28	108
2.2 ABS	85/100 kW (115-136 HP)	44-D-000 001	44-E-300 000	08-82	07-84	3283	K	26	25	56,5	96	E	4051	K		28	108
2.2 TURBO ABS	121 kW (164 HP)	44-J-200100		08-86	11-90	3200	K	26	28	56,5	45	E					
2.23	121 kW (165 HP)	44-H-000 001	44-K-300 000	08-86	07-89	3301	K	26	28	56,4		E	4051	K		28	108
2.23	85/101 kW (115-137 HP)	44-H-000 001	44-K-300 000	08-86	07-89	3073	K	26	25	56,5		E	4051	K		28	108
2.23 ABS	121 kW (165 HP)	44-H-000 001	44-J-200 099	08-86	12-87	3313	K	26	28	56,6	96	E	4051	K		28	108
2.23 ABS	85/101 kW (115-137 HP)	44-H-000 001	44-K-300 000	08-86	12-87	3283	K	26	25	56,5	96	E	4051	K		28	108
2.23 ABS	121 kW (165 HP)	44-J-200 100	44-M-200 099	01-88	12-89								4051	K		28	108
2.23 ABS 4-SPEED	85/101 kW (133-137 HP)	44-L-000 001	44-M-050 000	08-89	12-90	3292	K	38	25	59,6	45	E					
2.3	85/101 kW (115-137 HP)	44-F-000 001	44-K-300 000	08-84	07-89	3073	K	26	25	56,5		E	4051	K		28	108
2.3	85/101 kW (115-137 HP)	44-F-000 001	44-G-300 000	12-90	07-94	3293	K	38	30	59,4		E					
2.3 ABS 3-SPEED	98/100 kW (133-135 HP)	44-J-200100		86	11-90	3201	K	26	25	56,5	45	E	4051	K		28	108
2.3 3-SPEED	100 kW (136 HP)	44-L-000 001	44-M-050 000	08-89	12-90	3073	K	26	25	56,5		E	4051	K		28	108
2.3 ABS	85/101 kW (115-137 HP)	44-F-000 001	44-J-200 099	08-84	12-87	3283	K	26	25	56,5	96	E	4051	K		28	108
2.3 ABS	98/101 kW (133-137 HP)	44-F-000 001	44-K-300 000	08-84	07-89								4051	K		28	108
2.3 ABS	85 kW (115 HP)	44-F-000 001	44-G-300 000	08-84	07-86								4051	K		28	108
2.3 ABS	85/101 kW (115-137 HP)	44-M-000 001	44-R-120 000	01-88	07-89								4051	K		28	108
2.3 ABS	85/101 kW (115-138 HP)	4A-M-000 001	4A-R-120 000	12-90	07-94	3311	K	38	30	59,6	45	E					



CHASSIS ↑

→ CHASSIS

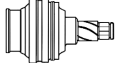





**G L O N .**

XXXX	K	A	B	C	ABS	P	XXXX	K	A	B	C
------	---	---	---	---	-----	---	------	---	---	---	---

AUDI

2.3 ABS 3-SPEED	85/101 kW (115-137 HP)	44-L-000 001	44-M-050 000	08-89	12-90	3292	K	38	25	59,6	45	E	4051	K		28	108
2.3 ABS 4-SPEED	85/101 kW (133-137 HP)	44-L-000 001	44-M-050 000	08-89	12-90	3292	K	38	25	59,6	45	E					
2.6	104/110 kW (142-150 HP)	4A-N-115 189	4A-R-120 000	04-92	07-94	3293	K	38	30	59,4		E					
2.6 ABS	104/110 kW (142-150 HP)	4A-N-115 189	4A-R-120 000	04-92	07-94	3311	K	38	30	59,6	45	E					
2.8 ABS (gear AEM)	128 kW (174 HP)	4A-M-000 001	4A-N-250 000	12-90	07-92	3302	K	38	27	59,5	45	E					
2.8 ABS (gear TURBO DIESEL)	128 kW (174 HP)	4A-N-101 453	4A-R-120 000	03-92	07-94	3302	K	38	27	59,5	45	E					
100 - 100 AVANT (M.T.)																	
1.6	63 kW (85 HP)	51 000 051	61 077 763	08-74	08-76	3073	K	26	25	56,5		E	4511	K		33	94
1.6	102 kW (139 HP)	4A-N-101 453	4A-R-120 000	03-92	07-94	3293	K	38	30	59,4		E	4051	K		28	108
1.6 ABS	102 kW (139 HP)	4A-N-101 453	4A-R-120 000	03-92	07-94	3311	K	38	30	59,6	45	E	4051	K		28	108
1.8	63/74 kW (85-100 HP)	51 000 051	61 077 763	08-74	08-76	3073	K	26	25	56,5		E	4511	K		33	94
1.8	55 kW (75 HP)	44-D-000 001	44-J-200 099	08-82	12-87	3073	K	26	25	56,5		E	4511	K		33	94
1.8	65/66 kW (88-90 HP)	44-D-090 541	44-J-200 099	03-83	12-87	3073	K	26	25	56,5		E	4511	K		33	94
1.8	65/66 kW (88-90 HP)	44-J-200 100	44-M-050 000	01-88	12-90	3291	K	38	25	59,5		E					
1.8 ABS	55 kW (75 HP)	44-F-000 001	44-J-200 099	08-84	12-87	3283	K	26	25	56,5	96	E	4511	K		33	94
1.8 ABS	65/66 kW (88-90 HP)	44-F-000 001	44-J-200 099	08-84	12-87	3283	K	26	25	56,5	96	E	4283	K		33	100
1.8 ABS	65/66 kW (88-90 HP)	44-J-200 100	44-M-050 000	01-88	12-90	3292	K	38	25	59,6	45	E	4283	K		33	100
1.9	82 kW (112 HP)	51 000 051	61 077 763	08-74	08-76	3073	K	26	25	56,5		E					
1.9	74 kW (100 HP)	43-B-000 001	44-E-300 000	08-80	07-84	3073	K	26	25	56,5		E	4051	K		28	108
2.0	77/85 kW (105-115 HP)	437 2000 001	438 2300 000	06-76	07-78	3073	K	26	25	56,5		E					
2.0	83/85 kW (113-115 HP)	44-F-000 001	44-J-200 099	08-86	12-87	3073	K	26	25	56,5		E	4051	K		28	108
2.0	85 kW (115 HP)	44-J-200 100	44-M-050 000	01-88	12-90	3291	K	38	25	59,5		E	4051	K		28	108
2.0	74/101 kW (100-137 HP)	4A-M-000 001	4A-R-120 000	12-90	07-94	3293	K	38	30	59,4		E	4051	K		28	108
2.0 ABS	83/85 kW (113-115 HP)	44-F-000 001	44-J-200 099	08-86	12-87	3283	K	26	25	56,5	96	E	4051	K		28	108
2.0 ABS	85 kW (115 HP)	44-J-200 100	44-M-050 000	01-88	12-90	3292	K	38	25	59,6	45	E	4051	K		28	108
2.0 ABS	74/85/101 kW (100-137 HP)	4A-M-000 001	4A-R-120 000	12-90	07-94	3311	K	38	30	59,6	45	E	4051	K		28	108
2.2	85/100 kW (115-136 HP)	437 2000 001	43-A-0040 621	06-76	10-79	3073	K	26	25	56,5		E					
2.2	85/100 kW (115-136 HP)	43-A-0040 622	44-E-300 000	10-79	07-84	3073	K	26	25	56,5		E	4051	K		28	108
2.2 ABS	85/100 kW (115-136 HP)	44-D-000 001	44-E-300 000	08-82	07-84	3283	K	26	25	56,5	96	E	4051	K		28	108
2.23	121 kW (165 HP)	44-H-000 001	44-K-300 000	08-86	12-87	3301	K	26	28	56,4		E	4051	K		28	108
2.23	85/101 kW (115-137 HP)	44-H-000 001	44-J-200 099	08-86	12-87	3073	K	26	25	56,5		E	4051	K		28	108
2.23	121 kW (165 HP)	44-J-200 100	44-M-050 000	01-88	12-90								4051	K		28	108
2.23	101 kW (137 HP)	44-J-200 100	44-M-050 000	01-88	12-90	3291	K	38	25	59,5		E	4051	K		28	108
2.23 ABS	121 kW (165 HP)	44-H-000 001	44-J-200 099	08-86	12-87	3313	K	26	28	56,6	96	E	4051	K		28	108
2.23 ABS	85/101 kW (115-137 HP)	44-H-000 001	44-J-200 099	08-86	12-87	3283	K	26	25	56,5	96	E	4051	K		28	108
2.23 ABS	121 kW (165 HP)	44-H-200 100	44-M-050 000	01-88	12-90								4051	K		28	108
2.23 ABS	101 kW (137 HP)	44-J-200 100	44-M-050 000	01-88	12-90	3292	K	38	25	59,6	45	E	4051	K		28	108
2.3	98/101 kW (133-137 HP)	44-E-034 756	44-E-300 000	10-83	07-84	3073	K	26	25	56,5		E	4051	K		28	108
2.3	98/101 kW (133-137 HP)	44-F-000 001	44-J-200 099	04-84	12-87	3073	K	26	25	56,5		E	4051	K		28	108
2.3	98/101 kW (133-137 HP)	44-J-200 100	44-M-050 000	01-88	12-90	3291	K	38	25	59,5		E	4051	K		28	108
2.3	98/101 kW (133-137 HP)	4A-M-000 001	4A-R-120 000	12-90	07-94	3293	K	38	30	59,4		E	4051	K		28	108
2.3 ABS	98/101 kW (133-137 HP)	44-E-034 756	44-E-300 000	10-83	12-87	3283	K	26	25	56,5	96	E	4051	K		28	108
2.3 ABS	98/101 kW (133-137 HP)	44-J-200 100	44-M-050 000	01-88	12-90	3292	K	38	25	59,6	45	E	4051	K		28	108
2.3 ABS	98/101 kW (133-138 HP)	4A-M-000 001	4A-R-120 000	12-90	07-94	3311	K	38	30	59,6	45	E	4051	K		28	108
2.3 TAXI	101 kW (137 HP)	44-E-034 756	44-E-300 000	10-83	07-84	3073	K	26	25	56,5		E	4051	K		28	108
2.3 TAXI ABS	101 kW (137 HP)	44-E-034 756	44-E-300 000	10-83	07-84								4051	K		28	108



	CHASSIS →	← CHASSIS		G L O N .											
															
				XXXX	K	A	B	C	ABS	P	XXXX	K	A	B	C

AUDI

2.6	104/110 kW (142-150 HP)	4A-N-115 189	4A-R-120 000	04-92	07-94	3293	K	38	30	59,4		E				
2.6 ABS	104/110 kW (142-150 HP)	4A-N-115 189	4A-R-120 000	04-92	07-94	3311	K	38	30	59,6	45	E				
100 - 100 AVANT DIESEL (A.T.)																
2.0 D	51 kW (70 HP)	43-C-000 001	44-K-300 000	08-81	07-89	3073	K	26	25	56,5		E	4051	K		28 108
2.0 D ABS	51 kW (70 HP)	44-F-000 001	44-J-200 099	08-84	12-87	3283	K	26	25	56,5	96	E	4051	K		28 108
2.0 D ABS	51 kW (70 HP)	44-J-200 100	44-K-300 000	01-88	07-89								4051	K		28 108
2.0 TURBO DIESEL	66 kW (90 HP)	43-C-031 546	44-J-200 099	11-81	12-87	3073	K	26	25	56,5		E	4051	K		28 108
2.0 TURBO DIESEL ABS	66 kW (90 HP)	44-F-000 001	44-J-200 099	08-84	12-87	3283	K	26	25	56,5	96	E	4051	K		28 108
2.4 D	60 kW (82 HP)	4A-M-000 001	4A-R-120 000	12-90	07-94	3293	K	38	30	59,4		E				
100 - 100 AVANT DIESEL (M.T.)																
2.0 D	51 kW (70 HP)	439 2045 830	43-A-0040 621	10-78	10-79	3073	K	26	25	56,5		E				
2.0 D	51 kW (70 HP)	43-A-0040 622	44-J-200 099	10-79	12-87	3073	K	26	25	56,5		E	4051	K		28 108
2.0 D ABS	51 kW (70 HP)	43-D-000 001	44-K-300 000	08-82	12-87	3283	K	26	25	56,5	96	E	4051	K		28 108
2.0 D ABS	51 kW (70 HP)	44-J-200 100	44-K-300 00	01-88	07-89	3311	K	38	30	59,6	45	E	4051	K		28 108
2.0 D ABS	51 kW (70 HP)	44-J-300 000	44-K-300 000	01-88	07-89	3292	K	38	25	59,6	45	E	4051	K		28 108
2.0 D TAXI	121 kW			10-78	07-82	3073	K	26	25	56,5		E	4051	K		28 108
2.0 D TAXI	51 kW (70 HP)	439 2045 830	43-A-0109 324	10-78	01-80	3301	K	26	28	56,4		E	4051	K		28 108
2.0 D TAXI	51 kW (70 HP)	43-A-0109 325	43-C-090 315	02-80	07-82	3073	K	26	25	56,5		E	4051	K		28 108
2.0 TURBO DIESEL	66 kW (90 HP)	43-C-031 546	44-J-200 099	11-81	12-87	3073	K	26	25	56,5		E	4051	K		28 108
2.0 TURBO DIESEL ABS	66 kW (90 HP)	43-D-000 001	44-J-200 099	08-82	12-87	3283	K	26	25	56,5	96	E	4051	K		28 108
2.0 TURBO DIESEL ABS	75 kW (102 HP)	44-J-224 409	44-M-050 000	03-88	12-90	3311	K	38	30	59,6	45	E	4051	K		28 108
2.0 TURBO DIESEL ABS	75 kW (102 HP)	44-J-224 409	44-M-050 000	03-88	12-90	3292	K	38	25	59,6	45	E	4051	K		28 108
2.4 D	60 kW (82 HP)	4A-L-000 001	4A-M-050 000	08-89	12-90	3291	K	38	25	59,5		E				
2.4 D	60 kW (82 HP)	4A-M-000 001	4A-R-120 000	01-91	07-94	3293	K	38	30	59,4		E				
2.4 TURBO DIESEL ABS	60 kW (82 HP)	44-L-000 001	44-M-050 000	08-89	12-90	3292	K	38	25	59,6	45	E				
2.5 TURBO DIESEL ABS	88 kW (120 HP)	44-I-046 514	44-M-050 000	01-90	12-90	3284	K	38	28	59,5	45	E				
2.5 TURBO DIESEL ABS	85 kW (115 HP)	4A-M-000 001	4A-R-120 000	01-91	07-94	3302	K	38	27	59,5	45	E				
100 - 100 AVANT QUATTRO FWD (A.T.)																
2.2 ABS	169 kW (230 HP)	4A-N-000 001	4A-R-150 000	08-91	07-94	3302	K	38	27	59,5	45	E				
2.8 ABS	128 kW (174 HP)	4A-M-000 001	4A-R-150 000	12-90	07-94	3302	K	38	27	59,5	45	E				
100 - 100 AVANT QUATTRO FWD (M.T.)																
1.8	65/66 kW (88-90 HP)	44-F-023 308	44-J-200 099	10-84	12-87	3073	K	26	25	56,5		E	4051	K		28 108
1.8 ABS	65/66 kW (88-90 HP)	44-F-023 308	44-J-200 099	10-84	12-87	3283	K	26	25	56,5	96	E	4051	K		28 108
1.8 ABS	65/66 kW (88-90 HP)	44-J-200 100	44-M-050 000	01-88	12-90	3292	K	38	25	59,6	45	E				
2.0 ABS	85 kW (115 HP)	4A-M-000 001	4A-N-200 000	12-90	07-92	3311	K	38	30	59,6	45	E				
2.0 ABS	103 kW (140 HP)	4A-P-000 001	4A-R-150 000	08-92	08-94	3311	K	38	30	59,6	45	E				
2.2	85 kW (115 HP)	44-G-000 001	44-G-300 000	08-85	07-86	3073	K	26	25	56,5		E	4051	K		28 108
2.2 TURBO ABS	169 kW (230 HP)	4A-N-000 001	4A-R-150 000	08-91	07-94	3302	K	38	27	59,5	45	E	4051	K		28 108
2.2 ABS	85 kW (115 HP)	44-G-000 001	44-G-300 000	08-85	07-86	3283	K	26	25	56,5	96	E	4051	K		28 108
2.2 TURBO	121 kW (165 HP)	44-G-102 130	44-J-200 099	03-86	12-87	3301	K	26	28	56,4		E	4051	K		28 108
2.2 TURBO ABS	121 kW (165 HP)	44-G-102 130	44-M-050 000	03-86	12-87	3313	K	26	28	56,6	96	E	4051	K		28 108
2.2 TURBO ABS	121 kW (165 HP)	44-J-200 100	44-M-050 000	01-88	12-90	3284	K	38	28	59,5	45	E	4051	K		28 108
2.23	101 kW (137 HP)	44-F-023 308	44-J-200 099	10-84	12-87	3073	K	26	25	56,5		E	4051	K		28 108
2.23 ABS	101 kW (137 HP)	44-F-023 308	44-J-200 099	10-84	12-87	3283	K	26	25	56,5	96	E	4051	K		28 108
2.3	101 kW	44-F-023 308	44-J-200 099	10-84	12-87	3073	K	26	25	56,5		E	4051	K		28 108
2.3	98/101 kW (133-137 HP)	44-F-023 308	44-J-200 099	10-84	12-87	3073	K	26	25	56,5		E	4051	K		28 108



CHASSIS ↑

→ CHASSIS

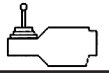
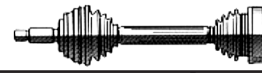





**G L O N .**

XXXX	K	A	B	C	ABS	P	XXXX	K	A	B	C

AUDI

2.3 ABS	98/101 kW (133-137 HP)	44-F-023 308	44-M-050 000	10-84	12-87	3283	K	26	25	56,5	96	E	4051	K		28	108
2.3 ABS	98/101 kW (133-137 HP)	44-J-200 100	44-M-050 000	01-88	12-90	3292	K	38	25	59,6	45	E	4051	K		28	108
2.3 ABS	98/101 kW (133-137 HP)	4A-M-000 001	4A-R-150 000	12-90	07-94	3311	K	38	30	59,6	45	E	4283	K		33	100
2.6 ABS	110 kW (150 HP)	4A-N-101- 453	4A-R-150 000	03-92	07-94	3311	K	38	30	59,6	45	E	4283	K		33	100
2.8 ABS	128 kW (174 HP)	4A-M-000 001	4A-R-150 000	12-90	07-94	3302	K	38	27	59,5	45	E	4051	K		28	108
4.2 ABS	206 kW (280 HP)	4A-P-040 001	4A-R-150 000	10-92	07-94	3302	K	38	27	59,5	45	E	4051	K		28	108
100 - 100 AVANT QUATTRO RWD (M.T.-A.T.)																	
1.8		44-F-023 308	44-J-200 099	10-84	12-87	3073	K	26	25	56,5		E	4051	K		28	108
1.8 ABS		44-F-023 308	44-J-200 099	10-84	12-87	3283	K	26	25	56,5	96	E	4051	K		28	108
1.8 ABS		44-J-200 100	44-M-050 000	01-88	12-90	3292	K	38	25	59,6	45	E	4051	K		28	108
2.0 ABS		4A-M-000 001	4A-N-200 000	12-90	07-92	3292	K	38	25	59,6	45	E					
2.0 ABS		4A-P-000 001	4A-R-150 000	08-92	08-94	3292	K	38	25	59,6	45	E					
2.2		44-F-023 308	44-J-200 099	10-84	12-87	3073	K	26	25	56,5		E	4051	K		28	108
2.2 ABS		44-F-023 308	44-G-300 000	10-84	07-86	3283	K	26	25	56,5	96	E	4051	K		28	108
2.2 ABS		44-H-000 001	44-J-200 099	08-86	12-87	3283	K	26	25	56,5	96	E	4051	K		28	108
2.2 ABS		4A-J-200 100	4A-R-150 000	01-88	07-94	3292	K	38	25	59,6	45	E	4051	K		28	108
2.23		44-F-023 308	44-J-200 099	10-84	12-87	3073	K	26	25	56,5		E	4051	K		28	108
2.23 ABS		44-F-023 308	44-J-200 099	10-84	12-87	3283	K	26	25	56,5	96	E	4051	K		28	108
2.23 ABS		44-J-200 100	44-M-050 000	01-88	12-90	3292	K	38	25	59,6	45	E	4051	K		28	108
2.3		44-F-023 308	44-J-200 099	10-84	12-87	3073	K	26	25	56,5		E	4051	K		28	108
2.3 ABS		44-F-023 308	44-J-200 099	10-84	12-87	3283	K	26	25	56,5	96	E	4051	K		28	108
2.3 ABS		44-J-200 100	44-M-050 000	01-88	12-90	3292	K	38	25	59,6	45	E	4051	K		28	108
2.3 ABS		44-J-200 100	44-M-050 000	12-90	07-94	3292	K	38	25	59,6	45	E					
2.6 ABS		4A-N-101 453	4A-R-150 000	03-92	07-94	3292	K	38	25	59,6	45	E					
2.8 ABS		4A-M-000 001	4A-R-150 000	12-90	07-94	3292	K	38	25	59,6	45	E	4051	K		28	108
4.2 ABS		4A-P-040 001	4A-R-150 000	10-92	07-94								4051	K		28	108
200 - 200 AVANT (A.T.)																	
2.23 ABS	121/147 kW (165-200 HP)	44-J-200 100	44-M-050 000	01-88	11-90								4051	K		28	108
2.23	101 kW (138 HP)	44-F-000 001	44-F-300 000	08-84	07-85	3073	K	26	25	56,5		E	4051	K		28	108
2.23	121 kW (165 HP)	44-G-000 001	44-J-200 099	08-85	12-87	3301	K	26	28	56,4		E	4051	K		28	108
2.23 ABS	101 kW (138 HP)	44-F-000 001	44-F-300 000	08-84	07-85	3283	K	26	25	56,5	96	E	4051	K		28	108
2.23 ABS	121 kW (165 HP)	44-G-000 001	44-J-200 099	08-85	12-87	3313	K	26	28	56,6	96	E	4051	K		28	108
5E 2.2	100 kW (136 HP)	43-A-0045 129	44-F-300 000	10-79	07-85	3073	K	26	25	56,5		E	4051	K		28	108
5E 2.2 ABS	100 kW (136 HP)	43-A-0045 129	44-F-300 000	10-79	07-85	3283	K	26	25	56,5	96	E	4051	K		28	108
5T 2.2	125/134 kW (170-182 HP)	43-A-0045 129	44-J-200 099	10-79	01-88	3301	K	26	28	56,4		E	4051	K		28	108
5T 2.2 ABS	125/134 kW (170-182 HP)	43-A-0045 129	44-J-200 099	10-79	01-88	3313	K	26	28	56,6	96	E	4051	K		28	108
200 - 200 AVANT (M.T.)																	
2.23	101 kW (138 HP)	44-F-000 001	44-F-300 000	08-84	07-85	3073	K	26	25	56,5		E	4051	K		28	108
2.23	121 kW (165 HP)	44-G-000 001	44-J-200 099	08-85	12-87	3301	K	26	28	56,4		E	4051	K		28	108
2.23 ABS	101 kW (138 HP)	44-F-000 001	44-F-300 000	08-84	07-85	3283	K	26	25	56,5	96	E	4051	K		28	108
2.23 ABS	121 kW (165 HP)	44-G-000 001	44-J-200 099	08-85	12-87	3313	K	26	28	56,6	96	E	4051	K		28	108
2.23 ABS	121/147 kW (165-200 HP)	44-J-200 100	44-M-050 000	01-88	11-90	3284	K	38	28	59,5	45	E	4051	K		28	108
5E 2.2	100 kW (136 HP)	43-A-0045 129	44-F-300 000	10-79	07-85	3073	K	26	25	56,5		E	4051	K		28	108
5E 2.2 ABS	100 kW (136 HP)	43-A-0045 129	44-F-300 000	10-79	07-85	3283	K	26	25	56,5	96	E	4051	K		28	108
5T 2.2	125/134 kW (170-182 HP)	43-A-0045 129	44-J-200 099	10-79	01-88	3301	K	26	28	56,4		E	4051	K		28	108
5T 2.2 ABS	125/134 kW (170-182 HP)	43-A-0045 129	44-J-200 099	10-79	01-88	3313	K	26	28	56,6	96	E	4051	K		28	108



	CHASSIS →	← CHASSIS		G L O N .										
				  			XXXX	K	A	B	C	ABS	P	XXXX

AUDI

200 - 200 AVANT QUATTRO FWD (M.T.)																	
2.2	134 kW (182 HP)	44-F-047 749	44-J-200 099	11-84	01-88	3301	K	26	28	56,4		E	4051	K		28	108
2.2 ABS	134 kW (182 HP)	44-F-047 749	44-J-200 099	11-84	01-88	3313	K	26	28	56,6	96	E	4051	K		28	108
2.2 TURBO ABS				01-89	12-91	3200	K	26	28	56,5	45	E	4051	K		28	108
2.23 ABS	121/147 kW (165-200 HP)	44-J-200 100	44-M-050 000	08-85	12-90	3284	K	38	28	59,5	45	E	4051	K		28	108
2.3 ABS	162 kW (220 HP)	44-J-200 100	44-M-050 000	02-88	12-90	3284	K	38	28	59,5	45	E	4051	K		28	108
200 - 200 AVANT QUATTRO RWD (M.T.-A.T.)																	
2.2	134 kW (182 HP)	44-F-047 749	44-J-200 099	11-84	01-88	3073	K	26	25	56,5		E	4051	K		28	108
2.2 ABS	134 kW (182 HP)	44-F-047 749	44-J-200 099	11-84	01-88	3283	K	26	25	56,5	96	E	4051	K		28	108
2.2 TURBO ABS				01-89	12-91	3200	K	26	28	56,5	45	E	4051	K		28	108
2.23 ABS	121/147 kW (165-200 HP)	44-J-200 100	44-M-050 000	02-88	12-90	3292	K	38	25	59,6	45	E	4051	K		28	108
2.3 ABS	162 kW (220 HP)	44-J-200 100	44-M-050 000	02-88	12-90	3292	K	38	25	59,6	45	E	4051	K		28	108
4000 (A.T.)																	
4 CYL				12-79	12-80	3505	K	22	30	51		E	4511	K		33	94
4 CYL				01-81	12-87	3548	K	22	30	51		I	4511	K		33	94
5 CYL COUPE'			85D-077-972	01-81	12-83	3548	K	22	30	51		I	4511	K		33	94
5 CYL COUPE'		85D-077-973		01-83	12-87	3547	K	22	30	51		I					
4000 D & TURBO DIESEL																	
TT				01-81	12-83	3301	K	26	28	56,4		E					
4000 (M.T.)																	
4 CYL				01-81	12-87	3548	K	22	30	51		I	4511	K		33	94
4 CYL (USA)				12-79	12-80	3505	K	22	30	51		E	4511	K		33	94
5 CYL COUPE'			85D-077-972	01-81	12-83	3548	K	22	30	51		I	4511	K		33	94
5 CYL COUPE'		85D-077-973		01-83	12-87	3547	K	22	30	51		I	4005	K		33	91,8
4000 QUATTRO																	
2.3 FWD				01-83	12-87	3547	K	22	30	51		I					
2.3 RWD				01-83	12-87	3301	K	26	28	56,4		E					
5000 (A.T.)																	
2,3		43-A-078-194		01-88	12-88	3073	K	26	25	56,5		E					
GAS		43A-0040-622		01-80	12-87	3073	K	26	25	56,5		E					
TURBO DIESEL				01-82	12-83	3073	K	26	25	56,5		E					
5000 (M.T.)																	
2.0 ABS	85 kW (115 HP)	8G-P-003 752		01-93		3139	K	33	30	53	45	I					
DIESEL-TURBO DIESEL				01-79	12-83	3301	K	26	28	56,4		E					
GAS		43A-0040-622		01-78	12-88	3073	K	26	25	56,5		E					
QUATTRO FWD (USA)				01-83	12-85	3301	K	26	28	56,4		E					
TT ABS		89-J-400 001		05-88		3139	K	33	30	53	45	I					
TURBO FWD			44-J-200-099	01-80	12-88	3301	K	26	28	56,4		E					
A3																	
1.6 M.T.	74 kW (101 HP)			12-96		3432	K	36	30	53		I	4511	K		33	94
A4 - A4 AVANT (M.T.)																	
1.6 ABS	74 kW (101 HP)	8D-S-000 001		11-94		3381	K	33	30	53	45	I	4283	K		33	100
1.8 ABS	92/110 kW (125-150 HP)	8D-S-000 001		11-94		3381	K	33	30	53	45	I	4051	K		28	108
1.9 TURBO DIESEL ABS	66 kW	8D-S-000 001		11-94		3381	K	33	30	53	45	I	4283	K		33	100
2.6 V6 ABS	110 kW(150 HP)	8D-S-000 001		11-94		3280	K	38	27	59,5	45	I					
2.8 V6 ABS	120/128 kW (163-174 HP)	8D-S-000 001		11-94		3280	K	38	27	59,5	45	I					



↑
CHASSIS

→
CHASSIS



G L O N .

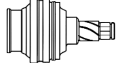
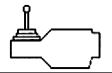







XXXX	K	A	B	C	ABS	P	XXXX	K	A	B	C
------	---	---	---	---	-----	---	------	---	---	---	---

AUDI

A4 - A4 AVANT (A.T.)														
1.6 ABS	74 kW (101 HP)	8D-S-000 001	11-94	3381	K	33	30	53	45	I	4283	K	33	100
1.8 ABS	92/110 kW (125-150 HP)	8D-S-000 001	11-94	3381	K	33	30	53	45	I	4051	K	28	108
1.9 TURBO DIESEL ABS	66 kW	8D-S-000 001	11-94	3381	K	33	30	53	45	I	4283	K	33	100
2.8 V6 ABS	120/128 kW (163-174 HP)	8D-S-000 001	11-94	3280	K	38	27	59,5	45	I				
A4 - A4 AVANT QUATTRO FWD (M.T.)														
1.8 ABS	92/110 kW (125-150 HP)	8D-S-000 001	11-94	3381	K	33	30	53	45	I	4283	K	33	100
2.6 V6 ABS	110 kW (150 HP)	8D-S-000 001	11-94								4283	K	33	100
2.8 V6 ABS	120/128 kW (163-174 HP)	8D-S-000 001	11-94								4283	K	33	100
A4 - A4 AVANT QUATTRO														
1.8 ABS RWD M.T.	88/92/110 kW (120-125-149 HP)		01-95	3491	K	33	30	53	45	I				
2.6 ABS RWD M.T.	110 kW (149 HP)		01-95	3491	K	33	30	53	45	I				
2.8, 30V ABS RWD M.T.	128/142 kW (174-193 HP)		01-95	3491	K	33	30	53	45	I				
A6 - A6 AVANT (A.T.)														
2.0 ABS (LEFT STEER.)	74/101 kW (101-137 HP)	4A-S-000 001	06-94	3311	K	38	30	59,6	45	E				
2.0 ABS (RIGHT STEER.)	74/101 kW (101-137 HP)	4A-S-000 001	06-94	3311	K	38	30	59,6	45	E				
2.6 ABS	102/110 kW (139-150 HP)	4A-S-000 001	06-94	3311	K	38	30	59,6	45	E				
2.8 ABS	120/128 kW (163-174 HP)	4A-S-000 001	06-94	3302	K	38	27	59,5	45	E				
A6 - A6 AVANT (M.T.)														
2.0 ABS	74/101 kW (101-137 HP)	4A-S-000 001	06-94	3311	K	38	30	59,6	45	E	4051	K	28	108
2.3 ABS	98 kW (133 HP)	4A-S-000 001	06-94	3311	K	38	30	59,6	45	E	4051	K	28	108
2.6 ABS	102/110 kW (139-150 HP)	4A-S-000 001	06-94	3311	K	38	30	59,6	45	E				
2.8 ABS	120/128 kW (163-174 HP)	4A-S-000 001	06-94	3302	K	38	27	59,5	45	E				
A6 - A6 AVANT DIESEL (A.T.)														
2.5 TURBO DIESEL ABS	85 kW (115 HP)	4A-S-000 001	06-94	3302	K	38	27	59,5	45	E				
A6 - A6 AVANT DIESEL (M.T.)														
2.5 TURBO DIESEL ABS	85 kW (115 HP)	4A-S-000 001	06-94	3302	K	38	27	59,5	45	E				
A6 - A6 AVANT QUATTRO FWD (A.T.)														
2.2 ABS (S6)	169 kW (230 HP)	4A-S-000 001	06-94	3302	K	38	27	59,5	45	E				
2.8 ABS	128 kW (174 HP)	4A-S-000 001	06-94	3302	K	38	27	59,5	45	E				
4.2 ABS (S6)	213 kW (290 HP)	4A-S-000 001	06-94	3302	K	38	27	59,5	45	E				
A6 - A6 AVANT QUATTRO FWD (M.T.)														
2.0 ABS	103 kW (140 HP)	4A-S-000 001	06-94	3311	K	38	30	59,6	45	E				
2.2 ABS (S6)	169 kW (230 HP)	4A-S-000 001	06-94	3302	K	38	27	59,5	45	E	4051	K	28	108
2.6 ABS	102/110 kW (139-150 HP)	4A-S-000 001	06-94	3311	K	38	30	59,6	45	E				
2.8 ABS	128 kW (174 HP)	4A-S-000 001	06-94	3302	K	38	27	59,5	45	E	4051	K	28	108
4.2 ABS (S6)	213 kW (290 HP)	4A-S-000 001	06-94	3302	K	38	27	59,5	45	E	4051	K	28	108
A6 - A6 AVANT QUATTRO RWD (M.T.- A.T.)														
2.0 ABS	103 kW (140 HP)	4A-S-000 001	06-94	3311	K	38	30	59,6	45	E				
2.2 ABS (S6)	169 kW (230 HP)	4A-S-000 001	06-94	3302	K	38	27	59,5	45	E	4051	K	28	108
2.6 ABS	102/110 kW (139-150 HP)	4A-S-000 001	06-94	3311	K	38	30	59,6	45	E				
2.8 ABS	128 kW (174 HP)	4A-S-000 001	06-94	3302	K	38	27	59,5	45	E	4051	K	28	108
4.2 ABS (S6)	213 kW (290 HP)	4A-S-000 001	06-94	3302	K	38	27	59,5	45	E	4051	K	28	108
A8 (M.T. - A.T.)														
2.8 ABS	128 kW (174 HP)	4D-R-000 001	06-94	3280	K	38	27	59,5	45	I				



	CHASSIS →	→ CHASSIS		G L O N .										
														
														
XXXX	K	A	B	C	ABS	P	XXXX	K	A	B	C			

AUDI

AUDI												
A8 QUATTRO FWD (M.T.)												
2.8 ABS	128 kW (174 HP)	4D-R-000 001		06-94			3280	K	38	27	59,5	45
4.2 ABS	220 kW (300 HP)	4D-R-000 001		06-94			3280	K	38	27	59,5	45
CABRIO (A.T.)												
2.0	85 kW	8G-P-003 752		01-93			3138	K	33	30	53	
2.0 ABS	85 kW (115 HP)	8G-P-003 752		01-93			3139	K	33	30	53	45
2.6 ABS	110 kW (150 HP)	8G-R-005 001		01-94			3302	K	38	27	59,5	45
2.8 ABS	128 kW (174 HP)	8G-P-003 323		11-92			3302	K	38	27	59,5	45
CABRIO (M.T.)												
2.0	85 kW	8G-P-003 752		01-93			3138	K	33	30	53	
2.0 ABS	85 kW (115 HP)	8G-P-003 752		01-93			3139	K	33	30	53	45
2.3	98 kW	8G-N-000 001		06-91			3138	K	33	30	53	4051 K 28 108
2.3 ABS	98 kW (133 HP)	8G-N-000 001		06-91			3139	K	33	30	53	45 4051 K 28 108
2.6 ABS	110 kW (150 HP)	8G-R-005 001		01-94			3302	K	38	27	59,5	45
2.8 ABS	128 kW (174 HP)	8G-P-003 323		11-92			3302	K	38	27	59,5	45
COUPE' (A.T.)												
1.8	55 kW	85-B-076 536	85-D-000 000	02-81	08-82		3548	K	22	30	51	4511 K 33 94
1.8	64/68 kW (87-93 HP)	85-D-019 465	85-J-010 000	09-82	07-88		3548	K	22	30	51	4511 K 33 94
1.9	85 kW (115 HP)	85-B-000 001	85-D-079 180	10-80	12-82		3548	K	22	30	51	4511 K 33 94
2.0	81/85 kW (111-115 HP)	85-E-000 001	85-G-220 000	08-83	07-86		3547	K	22	30	51	4048 K 33 100
2.0 3-SPEED	85 kW (115 HP)	8B-K-010 381	8B-M-020 000	05-89	07-91		3138	K	33	30	53	
2.0 ABS 3-SPEED	85 kW (115 HP)	8B-K-010 381	8B-M-020 000	05-89	07-91		3139	K	33	30	53	45 4051 K 28 108
2.0 ABS 4-SPEED	85 kW (115 HP)	8B-N-001 461		09-91			3139	K	33	30	53	45
2.23	85 kW (115 HP)	85-F-094 729	85-J-010 000	01-85	07-88		3547	K	22	30	51	4048 K 33 100
2.23	100 kW (136 HP)	85-F-020 411	85-J-010 000	09-84	07-88		3212	K	22	25	51	E 4051 K 28 108
2.23 ABS	100 kW (136 HP)	85-F-020 411	85-J-010 000	09-84	07-88		3234	K	22	25	50,8	96 4051 K 28 108
2.3	98/100 kW (133-136 HP)	85-H-025 684	85-J-010 000	02-87	07-88		3212	K	22	25	51	E 4051 K 28 108
2.3 ABS	98/100 kW (133-136 HP)	85-H-025 684	85-J-010 000	02-87	07-88		3234	K	22	25	50,8	96 4051 K 28 108
2.3 ABS	125 kW (170 HP)	8B-L-000 001	8B-M-020 000	08-89	07-91		3302	K	38	27	59,5	45
2.6 ABS	110 kW (150 HP)	8B-N-015 001		08-92			3302	K	38	27	59,5	45
2.8 ABS	128 kW (174 HP)	8B-N-001 461		09-91			3302	K	38	27	59,5	45
4 CYL		85-B-000 001		10-80			3548	K	22	30	51	4511 K 33 94
5 CYL		85-B-000 001	85-D-077 973	10-80	12-82		3548	K	22	30	51	
5 CYL	85 kW	85-D-077-974		01-83			3547	K	22	30	51	
5 CYL	96 kW	85-F-000 001		07-84			3212	K	22	25	51	E 4051 K 28 108
5 CYL ABS	96 kW	85-F-000 001		07-84			3234	K	22	25	50,8	96 4051 K 28 108
COUPE' (M.T.)												
1.8	55 kW	85-B-076 536	85-D-000 000	02-81	08-82		3548	K	22	30	51	4511 K 33 94
1.8	64/68 kW (87-93 HP)	85-D-019 465	85-J-010 000	09-82	07-88		3548	K	22	30	51	4511 K 33 94
1.8	79/82 kW (108-112 HP)	85-H-000 001	85-J-010 000	08-86	07-88		3547	K	22	30	51	4048 K 33 100
1.8	82 kW (112 HP)	8B-K-000 001	8B-M-020 000	11-88	07-91		3138	K	33	30	53	
1.8 ABS	82 kW (112 HP)	8B-K-000 001	8B-M-020 000	11-88	07-91		3139	K	33	30	53	45
1.9	85 kW (115 HP)	85-B-000 001	85-D-079 180	10-80	12-82		3548	K	22	30	51	4511 K 33 94
2.0	81/85 kW (111-115 HP)	85-E-000 001	85-G-220 000	08-83	07-86		3547	K	22	30	51	4048 K 33 100
2.0	85 kW (115 HP)	8B-K-010 381		05-89			3138	K	33	30	53	
2.0	118 kW (160 HP)	8B-J-020 001	8B-M-020 000	08-89	07-91		3138	K	33	30	53	4051 K 28 108



CHASSIS ↑

→ CHASSIS



G L O N .

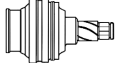
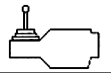
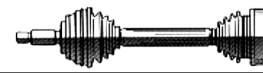

XXXX	K	A	B	C	ABS	P	XXXX	K	A	B	C
------	---	---	---	---	-----	---	------	---	---	---	---

AUDI

2.0	101/103 kW (137-140 HP)	8B-N-005 693		01-92		3138	K	33	30	53		I	4051	K		28	108
2.0 ABS	85 kW (115 HP)	8B-K-010 381		05-89		3139	K	33	30	53	45	I					
2.0 ABS	118 kW (160 HP)	8B-J-020 001	8B-M-020 000	08-89	07-91	3139	K	33	30	53	45	I	4051	K		28	108
2.0 ABS	101/103 kW (137-140 HP)	8B-N-005 693		01-92		3139	K	33	30	53	45	I	4051	K		28	108
2.2	77/85 kW (105-115 HP)	85-B-076 537	85-C-250 000	02-81	08-82	3548	K	22	30	51		I	4511	K		33	94
2.2	96 kW (130 HP)	85-C-013 212	85-E-220 000	09-81	07-84	3212	K	22	25	51		E	4051	K		28	108
2.23	100 kW (136 HP)	85-F-020 411	85-J-010 000	09-84	07-88	3212	K	22	25	51		E	4051	K		28	108
2.23	85 kW (115 HP)	85-F-094 729	85-J-010 000	01-85	07-88	3547	K	22	30	51		I	4048	K		33	100
2.23	100 kW (136 HP)	8B-K-000 001	8B-M-020 000	11-88	07-91	3138	K	33	30	53		I	4051	K		28	108
2.23 ABS	100 kW (136 HP)	85-F-020 411	85-J-010 000	09-84	07-88	3234	K	22	25	50,8	96	I	4051	K		28	108
2.23 ABS	100 kW (136 HP)	8B-K-000 001	8B-M-020 000	11-88	07-91	3139	K	33	30	53	45	I	4051	K		28	108
2.3	98/100 kW (133-136 HP)	85-H-025 684	85-J-010 000	02-87	07-88	3212	K	22	25	51		E	4051	K		28	108
2.3	98/100 kW (133-136 HP)	8B-K-000 001		11-88		3138	K	33	30	53		I	4051	K		28	108
2.3 ABS	98/100 kW (133-136 HP)	85-H-025 684	85-J-010 000	02-87	07-88	3234	K	22	25	50,8	96	I	4051	K		28	108
2.3 ABS	98/100 kW (133-136 HP)	8B-K-000 001		11-88		3139	K	33	30	53	45	I	4051	K		28	108
2.3 ABS	125 kW (170 HP)	8B-L-000 001	8B-M-020 000	08-89	07-91	3302	K	38	27	59,5	45	I	4051	K		28	108
2.6 ABS	110 kW (150 HP)	8B-N-015 001		08-92		3302	K	38	27	59,5	45	I					
2.8 ABS	128 kW (174)	8B-N-001 461		09-91		3302	K	38	27	59,5	45	I					
4 CYL		85-B-000 001		10-80		3548	K	22	30	51		I	4511	K		33	94
5 CYL	96 kW	85-F-000 001		07-84		3212	K	22	25	51		E	4051	K		28	108
5 CYL ABS	96 kW			07-84		3234	K	22	25	50,8	96	I	4051	K		28	108
FOX (A.T.)																	
TT				01-74	12-79	3505	K	22	30	51		E	4511	K		33	94
FOX (M.T.)																	
TT				01-73	12-79	3505	K	22	30	51		E	4511	K		33	94
QUATTRO FWD (A.T.-M.T.)																	
2.2-2.3	119/225 (162-306 HP)	85-A-900 001	85-M-000 999	07-80	07-91								4051	K		28	108
2.2-2.3 ABS	119/225 (162-306 HP)	85-A-900 708	85-M-000 999	01-86	07-91								4051	K		28	108
V8 RWD (A.T. & M.T.)																	
TT		44-K-000 001	4C-R-005 000	10-88	11-93								4051	K		28	108



	CHASSIS →	→ CHASSIS		G L O N .											
				XXXX	K	A	B	C	ABS	P	XXXX	K	A	B	C

AUTOBIANCHI

A 112 (M.T.)															
0,9	30/31 kW (40-42 HP)	01-69	12-79	3501	K	20	20	43,1		E					
0,9	30/31 kW (40-42 HP)	01-80	12-86	3501	K	20	20	43,1		E					
1.0	35 kW (48 HP)	11-77	12-79	3501	K	20	20	43,1		E					
1.0	35 kW (48 HP)	01-80	12-86	3501	K	20	20	43,1		E					
1.05	51 kW (70 HP)	01-80	12-86	3501	K	20	20	43,1		E					
Y 10 (M.T.)															
1.0	33 kW (45 HP)	01-85	06-96	3501	K	20	20	43,1		E					
1.1	41 kW (55 HP)	01-85	06-96	3501	K	20	20	43,1		E					
1.3	53/54 kW (72-74 HP)	01-85	06-96	3501	K	20	20	43,1		E					
Y 10 4WD, FWD (M.T.)															
1.0	32/37 kW (44-50 HP)	09-86	12-89	3501	K	20	20	43,1		E					
1.1	37/38 kW (50-51 HP)	12-89	06-96	3501	K	20	20	43,1		E					

BELLIER

VX				3115	K	18	18	42		E	4015	K	18	18	62
----	--	--	--	------	---	----	----	----	--	---	------	---	----	----	----

BLMC → ROVER

BRITISH LEYLAND → ROVER

BUICK (GENERAL MOTORS)

CENTURY (COUPE - SEDAN - WAGON)															
2.2, 3 SPEED, A.T.		01-93	12-93	3130		27	29	61,5		E					
2.5, 3 SPEED, A.T.		01-90	12-92	3130		27	29	61,5		E					
2.5, 4 CYL, 3 SPEED, A.T. 24 MM DIA SPINDLE THREAD		01-89	12-89	3130		27	29	61,5		E					
4 CYL ".785" OUTBOARD JOINT THREADED END"		01-89	12-89	3017	K	33	29	47,7		E					
4 CYL ".940" OUTBOARD JOINT THREADED END"		01-89	12-89	3130		27	29	61,5		E					
4 CYL		01-90	12-90	3130		27	29	61,5		E					
4 CYL, 3 SPEED, A.T		01-91	12-92	3130		27	29	61,5		E					
4 CYL, 3 SPEED, A.T. ".785" OUTBOARD JOINT THREADED END"		01-88	12-88	3017	K	33	29	47,7		E					
CENTURY, CENTURY SS (MEXICO)		01-83	12-85	3114	K	33	23	47,6		I					



CHASSIS ↑

→ CHASSIS

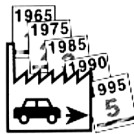
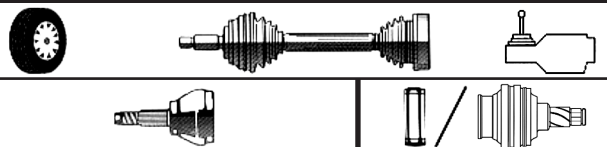





**G L O N .**

XXXX K A B C ABS P XXXX K A B C

BUICK (GENERAL MOTORS)

TT			01-82	12-82	3017	K	33	29	47,7	E									
TT	“.940” OUTBOARD JOINT THREADED END		01-83	12-83	3026	K	27	32	61,5	E									
TT	20 MM DIA SPINDLE THREAD		01-83	12-83	3017	K	33	29	47,7	E									
TT	24 MM DIA SPINDLE THREAD		01-83	12-83	3026	K	27	32	61,5	E									
TT			01-86	12-88	3386	K	33	24	47,6	I									
TT, 3 SPEED, A.T.	“.940” OUTBOARD JOINT THREADED END		01-84	12-84	3026	K	27	32	61,5	E									
TT, 3 SPEED, A.T.	20 MM DIA SPINDLE THREAD		01-84	12-84	3017	K	33	29	47,7	E									
TT, 3 SPEED, A.T.	24 MM DIA SPINDLE THREAD		01-84	12-84	3026	K	27	32	61,5	E									
TT, 3 SPEED, A.T.	“.785” OUTBOARD JOINT THREADED END		01-85	12-87	3017	K	33	29	47,7	E									
TT, 4 SPEED A.T.	20 MM DIA SPINDLE THREAD		01-84	12-84	3017	K	33	29	47,7	E									
TT, 4 SPEED A.T.	24 MM DIA SPINDLE THREAD		01-84	12-84	3026	K	27	32	61,5	E									
TT, 4 SPEED, A.T.	“.940” OUTBOARD JOINT THREADED END		01-84	12-84	3026	K	27	32	61,5	E									
ELECTRA																			
TT	NO RWD ESTATE WAGON		01-85	12-85	3026	K	27	32	61,5	E									
PARK AVENUE																			
TT	DESIGN I		01-85	12-85	3026	K	27	32	61,5	E									
REATA																			
TT			01-91	12-91	3135		33	32	61,5	47	E								
TT ABS			01-90	12-91	3135		33	32	61,5	47	E								
TT NO ABS			01-90	12-90	3134		33	32	61,5		E								
REGAL																			
TT			01-88	12-92	3132		33	32	73		E								
TT ABS			01-88	12-92	3133		33	32	73	47	E								
RIVIERA																			
TT		4Z57R9E107255	01-79	12-79	3037	K	27	34	55,9		M								
TT		4Z57R9E107256	01-79	12-79	3018		27	34	55,9		E								
TT			01-80	12-84	3018		27	34	55,9		E								
TT			01-89	12-90	3134		33	32	61,5		E								
TT ABS			01-89	12-91	3135		33	32	61,5	47	E								
SKYHAWK																			
TT, A.T.			01-85	12-89	3017	K	33	29	47,7		E								
TT, M.T.	NO '87 TURBO		01-85	12-89	3017	K	33	29	47,7		E								
SKYLARK																			
4 CYL, A.T.			01-85	12-85	3017	K	33	29	47,7		E								
TT			01-88	12-91	3017	K	33	29	47,7		E								
TT ABS			01-92	12-92	3155	K	33	32	63	48	E								
TT V6, A.T.			01-85	12-85	3017	K	33	29	47,7		E								
TT, A.T.			01-86	12-87	3017	K	33	29	47,7		E								
TT, M.T.			01-85	12-85	3017	K	33	29	47,7		E								
SOMERSET & SOMERSET REGAL																			
TT, A.T.			01-85	12-87	3017	K	33	29	47,7		E								



	CHASSIS →	→ CHASSIS		G L O N .												
																
																
					XXXX	K	A	B	C	ABS	P	XXXX	K	A	B	C

CADILLAC (GENERAL MOTORS)

ALLANTE																
TT ABS			01-89	12-92	3135		33	32	61,5	47	E					
CIMARRON																
TT			01-82	12-88	3017	K	33	29	47,7		E					
DE VILLE																
TT	DESIGN I		01-85	12-85	3026	K	27	32	61,5		E					
TT NO ABS	HEAVY DUTY BRAKES		01-91	12-93	3134		33	32	61,5		E					
ELDORADO																
TT		6L57B9E609659	01-79	12-79	3018		27	34	55,9		E					
TT		6L57B9E609658	01-79	12-79	3037	K	27	34	55,9		M					
TT			01-80	12-84	3018		27	34	55,9		E					
TT ABS			01-89	12-91	3135		33	32	61,5	47	E					
TT NO ABS			01-89	12-90	3134		33	32	61,5		E					
FLEETWOOD																
TT	DESIGN I		01-85	12-85	3026	K	27	32	61,5		E					
TT NO ABS	HEAVY DUTY BRAKES		01-91	12-93	3134		33	32	61,5		E					
SEVILLE																
TT			01-80	12-84	3018		27	34	55,9		E					
TT ABS			01-89	12-91	3135		33	32	61,5	47	E					
TT NO ABS			01-89	12-90	3134		33	32	61,5		E					

CARLETTI

TOP 500					3115	K	18	18	42		E	4015	K	18	18	62

CASALINI

SULKYDEA 500					3115	K	18	18	42		E	4015	K	18	18	62



CHASSIS →

→ CHASSIS

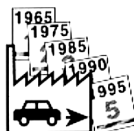

G L O N .



XXXX K A B C ABS P XXXX K A B C

CHATENET

STELLA 214					3115	K	18	18	42		E	4015	K	18	18	62

CHEVROLET (GENERAL MOTORS)

ASTRO VAN 4WD																
TT		01-90	12-91		3222		33	35	77		E					
BERETTA																
TT 4 CYL		01-87	12-88		3017	K	33	29	47,7		E					
TT 4 CYL (NO QUAD 4)		01-89	12-90		3017	K	33	29	47,7		E					
TT 4 CYL (NO QUAD 4)		01-91	12-91		3017	K	33	29	47,7		E					
TT V6 A.T.		01-87	12-91		3017	K	33	29	47,7		E					
CAVALIER																
TT		01-82	12-82		3017	K	33	29	47,7		E					
TT 4 CYL		01-91	12-91		3017	K	33	29	47,7		E					
TT 4 CYL M.T.		01-85	12-90		3017	K	33	29	47,7		E					
TT A.T.		01-85	12-90		3017	K	33	29	47,7		E					
TT ABS		01-92			3397	K	33	29	47,7	48	E					
TT V6 A.T.		01-91	12-91		3017	K	33	29	47,7		E					
CELEBRITY (COUPE - SEDAN - WAGON)																
2.5, 3 SPEED, A.T.		01-90	12-90		3130		27	29	61,5		E					
4 CYL, 3 SP, A.T. 24 MM DIA SPINDLE THREAD		01-89	12-89		3130		27	29	61,5		E					
4 CYL, A.T. 20 MM DIA SPINDLE THREAD		01-84	12-87		3017	K	33	29	47,7		E					
4 CYL, A.T. 24 MM DIA SPINDLE THREAD		01-84	12-84		3026	K	27	32	61,5		E					
TT		01-82	12-82		3017	K	33	29	47,7		E					
TT 20 MM DIA SPINDLE THREAD		01-83	12-83		3017	K	33	29	47,7		E					
TT 24 MM DIA SPINDLE THREAD		01-83	12-84		3026	K	27	32	61,5		E					
TT (MEXICO)		01-82	12-85		3114	K	33	23	47,6		I					
TT, 3 SPEED, A.T. 20 MM DIA SPINDLE THREAD		01-84	12-87		3017	K	33	29	47,7		E					
CHEVY																
TT ABS		01-96			3431	K	22	28	52		I					
CITATION & CITATION II																
TT		01-80	12-85		3017	K	33	29	47,7		E					
TT (MEXICO)		01-82	12-85		3114	K	33	23	47,6		I					
CORSICA																
TT 4 CYL		01-87	12-88		3017	K	33	29	47,7		E					
TT 4 CYL (NO QUAD 4)		01-89	12-91		3017	K	33	29	47,7		E					
TT V6 A.T.		01-87	12-91		3017	K	33	29	47,7		E					
LUMINA																
2.5, 3 SPEED, A.T.		01-90	12-92		3131		33	29	73		E					
3.1, 3 SPEED, A.T. ABS		01-90	12-91		3133		33	32	73	47	E					



	CHASSIS →	← CHASSIS		G L O N .									
				XXXX	K	A	B	C	ABS	P	XXXX	K	A

CHEVROLET (GENERAL MOTORS)

3.1, 3 SPEED, A.T. NO ABS			01-90	12-91	3132		33	32	73		E								
3.1, 4 SPEED, A.T. ABS			01-90	12-92	3133		33	32	73	47	E								
3.1, 4 SPEED, A.T. NO ABS			01-90	12-92	3132		33	32	73		E								
3.4, 4 SPEED, A.T. ABS			01-92	12-92	3133		33	32	73	47	E								
3.4, 4 SPEED, A.T. NO ABS			01-92	12-92	3132		33	32	73		E								
3.4, 5 SPEED, M.T. ABS			01-91	12-92	3133		33	32	73	47	E								
3.4, 5 SPEED, M.T. NO ABS			01-91	12-92	3132		33	32	73		E								
NOVA																			
TT (NO '88 TWIN CAM)			01-85	12-88	3596	K	26	29	56		E								
PICK UP 1/2 TON 4WD & SUBURBAN																			
TT			01-88	12-92	3222		33	35	77		E								
PICK UP 3/4 TON 4WD & SUBURBAN																			
TT			01-88	12-88	3222		33	35	77		E								
TT (7200 GVWR)			01-89	12-92	3222		33	35	77		E								
TT (8600 GVWR)			01-89	12-92	3221		33	29	80		E								
PICK UP 1 TON 4WD & CHASSIS CAB																			
TT			01-88	12-92	3221		33	29	80		E								
S10 BLAZER 4WD & PICK UP																			
TT			01-83	12-84	3029														
TT			01-85	12-90	3018		27	34	55,9		E								

CHRYSLER

DART, LEBARON, MAGNUM, NEW YORKER, VOLARE																			
TT			01-84	12-87	3521	K	26	23	54		I								
DART, LEBARON, NEW YORKER, VOLARE																			
			84	86	3446	K	26	23	54		I								
CHAMP																			
TT			01-78	12-82	3044	K	25	22	50		M								
COLT																			
1.4 - 1.6			01-79	12-84	3044	K	25	22	50		M								
1.6 TURBO			01-84	12-86	3142	K	25	23	50		M								
COLT VISTA																			
2.0 FWD			01-84	12-87	3142	K	25	23	50		M								
IMPERIAL																			
3.0	GKN DESIGN		01-90	12-90	3117	K	26	32	54		I								
LASER																			
2.2	CITROEN DESIGN		01-84	12-85	3027		26	23	54		I								



CHASSIS ↑

→ CHASSIS



G L O N .

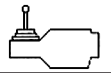





XXXX	K	A	B	C	ABS	P	XXXX	K	A	B	C
------	---	---	---	---	-----	---	------	---	---	---	---

CHRYSLER

2.2	SAGINAW DESIGN		01-86	12-86	3066		26	29	54		E								
2.2 (NO TURBO)	ACI DESIGN		01-84	12-86	3065		26	28	54		I								
2.2 (NO TURBO)	GKN DESIGN		01-84	12-86	3040		26	22	54		I								
2.2 ABS	SAGINAW DESIGN		02-86	12-86	3159		26	29	54	47	E								
2.2 TURBO	CITROEN DESIGN		03-86	12-86	3027		26	23	54		I								
2.5	GKN DESIGN		01-86	12-86	3521	K	26	23	54		I								
2.5	SAGINAW DESIGN		01-86	12-86	3066		26	29	54		E								
2.5	CITROEN DESIGN		01-86	12-86	3027		26	23	54		I								
2.5 ABS	SAGINAW DESIGN		01-86	12-86	3159		26	29	54	47	E								
LE BARON & LE BARON GTS (INCL. TOWN & COUNTRY WAGON)																			
2.2	GKN DESIGN		05-83	12-83	3042		26	22	54		I								
2.2	SAGINAW DESIGN		01-86	12-88	3065		26	28	54		I								
2.2	ACI DESIGN		01-87	12-88	3117	K	26	32	54		I								
2.2	GKN DESIGN		01-87	12-88	3117	K	26	32	54		I								
2.2 (NO TURBO)	ACI DESIGN		01-84	12-86	3065		26	28	54		I								
2.2 (NO TURBO)	CITROEN DESIGN		01-84	12-85	3027		26	23	54		I								
2.2 (NO TURBO)	GKN DESIGN		01-84	12-86	3040		26	22	54		I								
2.2 ABS	SAGINAW DESIGN		01-86	12-88	3159		26	29	54	47	E								
2.2 TURBO	CITROEN DESIGN		01-84	12-86	3027		26	23	54		I								
2.5	CITROEN DESIGN		01-86	12-86	3066		26	29	54		E								
2.5	GKN-1 DESIGN		01-86	12-87	3521	K	26	23	54		I								
2.5	SAGINAW DESIGN		01-86	12-88	3066		26	29	54		E								
2.5	GKN-2 DESIGN		01-87	12-88	3065		26	28	54		I								
2.5 A.T.	GKN DESIGN		01-92	12-93	3136		26	30	54		I								
2.5 A.T. ABS	GKN DESIGN		01-92	12-93	3137		26	30	54	47	I								
2.5 ABS	SAGINAW DESIGN		01-86	12-88	3159		26	29	54	47	E								
2.5 TURBO A.T.	GKN DESIGN		01-92	12-92	3136		26	30	54		I								
2.5 TURBO A.T. ABS	GKN DESIGN		01-92	12-92	3137		26	30	54	47	I								
2.6	CITROEN DESIGN		01-84	12-85	3027		26	23	54		I								
2.6	GKN DESIGN		01-85	12-85	3521	K	26	23	54		I								
3.0 A.T.	GKN DESIGN		01-92	12-93	3136		26	30	54		I								
3.0 A.T. ABS	GKN DESIGN		01-92	12-93	3137		26	30	54	47	I								
COUPE' & CONVERTIBLE ABS (NO 2.5 NON TURBO A.T.)			01-91	12-91	3160	K	26	32	54	47	E								
COUPE' & CONVERTIBLE, 2.5 NON TURBO A.T.			01-91	12-91	3117	K	26	32	54		I								
COUPE' & CONVERTIBLE, ABS			01-91	12-91	3066		26	29	54		E								
COUPE' & CONVERTIBLE, ABS, 2.5 NON TURBO A.T.			01-91	12-91	3159		26	29	54	47	E								
TT	CITROEN DESIGN		01-82	12-83	3027		26	23	54		I								
TT	GKN DESIGN		01-82	12-82	3521	K	26	23	54		I								
TT (NO 2.2 05/83>)	GKN DESIGN		01-83	12-83	3521	K	26	23	54		I								
TT (NO TURBO)	ACI DESIGN		01-89	12-90	3117	K	26	32	54		I								
TT (NO TURBO)	GKN DESIGN		01-89	12-90	3066		26	29	54		E								
TT (NO TURBO) ABS	SAGINAW DESIGN		01-89	12-90	3159		26	29	54	47	E								
TT (NO TURBO), ABS	SAGINAW DESIGN		01-89	12-90	3117	K	26	32	54		I								
TT 4 DOOR SEDANS ABS			01-91	12-91	3158	K	26	32	54	47	I								
TT 4 DOOR SEDANS, ABS			01-91	12-92	3158	K	26	32	54	47	I								
TT FWD TOWN & COUNTRY VAN			01-90	12-90	3128	K	26	32	54		E								



	CHASSIS →	→ CHASSIS		G L O N .														
																		
				XXXX	K	A	B	C	ABS	P	XXXX	K	A	B	C	XXXX	K	A

CHRYSLER

Model	Design	Start	End	Code	K	A	B	C	ABS	P	XXXX	K	A	B	C
TT TURBO	GKN DESIGN	01-89	12-90	3066		26	29	54		E					
TT TURBO	SAGINAW DESIGN	01-89	12-90	3117	K	26	32	54		I					
TT TURBO, ABS	SAGINAW DESIGN	01-89	12-90	3159		26	29	54	47	E					
NEW YORKER, E CLASS, EXECUTIVE SEDAN, FIFTH AVENUE, LIMOUSINE & SALON															
2.2	GKN DESIGN	05-83	12-83	3042		26	22	54		I					
2.2 (NO TURBO)	ACI DESIGN	01-84	12-84	3065		26	28	54		I					
2.2 (NO TURBO)	CITROEN DESIGN	01-84	12-84	3027		26	23	54		I					
2.2 (NO TURBO)	GKN DESIGN	01-84	12-84	3040		26	22	54		I					
2.2 TURBO		01-84	12-84	3027		26	23	54		I					
2.6		01-84	12-84	3027		26	23	54		I					
TT	CITROEN DESIGN	01-83	12-83	3027		26	23	54		I					
TT	GKN DESIGN	01-89	12-90	3117	K	26	32	54		I					
TT	SAGINAW DESIGN	01-89	12-89	3066		26	29	54		E					
TT		01-91	12-92	3128	K	26	32	54		E					
TT ABS	SAGINAW DESIGN	01-89	12-89	3159		26	29	54	47	E					
TT (NO 2.2 05/83>)	GKN DESIGN	01-83	12-83	3521	K	26	23	54		I					
TT (NO TURBO)	CITROEN DESIGN	01-85	12-86	3027		26	23	54		I					
TT (NO TURBO)	GKN DESIGN	01-85	12-86	3521	K	26	23	54		I					
TT (NO TURBO)	SAGINAW DESIGN	01-85	12-87	3066		26	29	54		E					
TT (NO TURBO)	GKN-1 DESIGN	01-87	12-87	3521	K	26	23	54		I					
TT (NO TURBO)	GKN-2 DESIGN	01-87	12-87	3117	K	26	32	54		I					
TT (NO TURBO)		01-88	12-88	3117	K	26	32	54		I					
TT (NO TURBO), ABS	SAGINAW DESIGN	01-85	12-87	3159		26	29	54	47	E					
TT (NO TURBO), ABS		01-88	12-88	3158	K	26	32	54	47	I					
TT ABS		01-91	12-92	3160	K	26	32	54	47	E					
TT TURBO	CITROEN DESIGN	01-85	12-87	3027		26	23	54		I					
TT TURBO	SAGINAW DESIGN	01-85	12-88	3066		26	29	54		E					
TT TURBO	GKN DESIGN	01-87	12-88	3117	K	26	32	54		I					
TT TURBO, ABS	SAGINAW DESIGN	01-85	12-88	3159		26	29	54	47	E					
NEW YORKER, PHANTOM, SHADOW, SPIRIT															
		90	95	3447	K	26	32	54		I					
NEON															
TT		01-94		3396	K	23	28	58		I					
TT ABS		01-94		3406	K	23	28	58	56	I					
SARATOGA (A.T)															
3.0i	Eng. V6 Body 104 kW (141 HP)			3158	K	26	32	54	47	I					
VOYAGER															
2.5 DIESEL GS YN2M C	85kW (115 HP)	96		3158	K	26	32	54	47	I					



CHASSIS ↑

→ CHASSIS

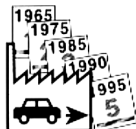

G L O N .

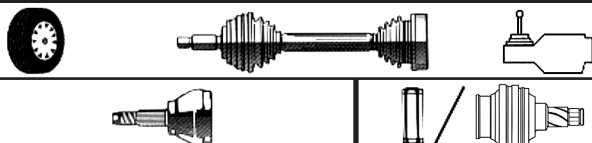









XXXX	K	A	B	C	ABS	P	XXXX	K	A	B	C
------	---	---	---	---	-----	---	------	---	---	---	---

CITROËN

AXEL																			
1,1			84	90	3467	K	24	22	54		I								
1,2			84	90	3467	K	24	22	54		I								
BERLINGO																			
1.8 ABS	Gear BE3 66 kW (90 HP)		07-97		3487	K	25	34	59	29	I								
1.9 DIESEL ABS	Gear BE3 50 kW (68 HP)		10-96		3487	K	25	34	59	29	I								
BX																			
1,1	40kW		05-88		3069	K	25	22	54,6		I								
1.4 (XB/ER/B/FG/H/D/DA/ES)	50/59 kW gear MA		05-88		3069	K	25	22	54,6		I								
1.5 RE	gear BE1/3		09-82		3069	K	25	22	54,6		I								
1.5, 1.6 ABS			07-85	04-87	3240	K	25	23	55,7	90	I								
1.6 (S/RS/TRS)	53/68 kW gear BE1/3		10-82		3069	K	25	22	54,6		I								
1.7 D, 1.9 D, 1.9 TURBO DIESEL ABS			07-85	04-87	3240	K	25	23	55,7	90	I								
1.7 DIESEL	gear BE1/3		09-82		3069	K	25	22	54,6		I								
1.9 GTi, 1.9 GTi 16V			07-85	04-87	3112	K	25	23	55,7		I								
1.9 GTi, 1.9 GTi 16V ABS			07-85	04-87	3240	K	25	23	55,7	90	I								
1.9 RD, 1.9 TRD	47/51 kW gear BE 1/3		09-83		3069	K	25	22	54,6		I								
1.9 TURBO DIESEL			03-88		3112	K	25	23	55,7		I								
1.9 TURBO, 1.9 TURBO DIESEL			07-85	04-87	3273	K	25	34	55,7		I								
1.9 TURBO, 1.9 TURBO DIESEL ABS			07-85	06-87	3308	K	25	34	55	90	I								
C 15																			
1.0			01-87		3090	K	21	22	56		I								
1.1			01-87		3090	K	21	22	56		I								
1.4			01-87		3090	K	21	22	56		I								
1.8 D			01-84		3420	K	21	31	56		I								
C 25																			
TT				07-87	3076	K	28	27	63		I								
EVASION																			
1.9 TURBO DIESEL	68 kW (92 HP)		03-95		3349	K	27	39	59		I								
1.9 TURBO DIESEL ABS	68 kW (92 HP)		03-95		3288	K	27	39	59	48	I								
2.0i.	89 kW (121 HP)		08-94		3348	K	27	34	59		I								
2.0i. ABS	89 kW (121 HP)		08-94		3287	K	27	34	59	48	I								
2.0i. TURBO	108 kW (147 HP)		08-94		3349	K	27	39	59		I								
2.0i. TURBO ABS	108 kW (147 HP)		08-94		3288	K	27	39	59	48	I								
2.1 TURBO DIESEL 12V	80 kW (109 HP)		08-96		3349	K	27	39	59		I								
2.1 TURBO DIESEL 12V ABS	80 kW (109 HP)		08-96		3288	K	27	39	59	48	I								
JUMPER																			
10-14 Q			01-94		3353	K	28	39	63		I								
10-14 Q ABS			01-94		3253	K	28	39	63	54	I								
18 Q			03-94		3278	K	35	45	70		I								
18 Q ABS			01-94		3254	K	35	45	70	54	I								
18 Q ABS	5235558		01-94		3465	K	35	45	70	54	I								
JUMPY																			
1.6, 1.9 DIESEL, ABS	51/58 kW (69-79 HP)		96		3287	K	27	34	59	48	I								
1.9 TURBO DIESEL ABS	66/68 kW (90-92 HP)		96		3288	K	27	39	59	48	I								





	CHASSIS →	→ CHASSIS		G L O N .											
															
															
				XXXX	K	A	B	C	ABS	P	XXXX	K	A	B	C





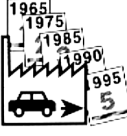



CITROËN

CITROËN															
Model	Year	Year	XXXX	K	A	B	C	ABS	P	XXXX	K	A	B	C	
VISA															
TT DIESEL	04-84	12-86	3090	K	21	22	56		I						
XANTIA															
1.6i 16V	07-95		3112	K	25	23	55,7		I						
1.6i ABS	03-93		3241	K	25	23	55,7	48	I						
1.6i, 1.8i, 2.0i, 2.0i 16V	03-93		3112	K	25	23	55,7		I						
1.8i, 2.0i ABS	03-93		3210	K	25	34	55,7	48	I						
1.9 D, 1.9 TURBO DIESEL	03-93		3112	K	25	23	55,7		I						
2.0 TURBO ABS 108 kW (147 HP)	06-95	01-98	3473	K	25	39	59	48	I						
2.1 TURBO DIESEL 12V ABS 80 kW (109 HP)	06-95	01-98	3473	K	25	39	59	48	I						
XM (M.T.)															
2.0i 16V, 2.0i TURBO	01-90		3351	K	28	23	57,7		I						
2.0i 16V, 2.0i TURBO ABS (BENDIX)	01-90		3243	K	28	23	58	48	I						
2.0i 16V, 2.0i TURBO ABS (BOSCH)	01-90		3412	K	28	23	58	29	I						
2.0i TURBO BREAK	01-90		3351	K	28	23	57,7		I						
2.0i TURBO BREAK ABS (BENDIX)	01-90		3243	K	28	23	58	48	I						
3.0i V6, 3.0i V6 BREAK	01-90		3352	K	28	27	57,7		I						
3.0i V6, 3.0i V6 BREAK ABS (BENDIX)	01-90		3244	K	28	27	58	48	I						
3.0i V6, 3.0i V6 BREAK ABS (BOSCH)	01-90		3413	K	28	27	58	29	I						
XM (A.T.)															
2.0i 16V, 2.0i TURBO	01-90		3351	K	28	23	57,7		I						
2.0i 16V, 2.0i TURBO ABS (BENDIX)	01-90		3243	K	28	23	58	48	I						
2.0i TURBO BREAK	01-90		3351	K	28	23	57,7		I						
2.0i TURBO BREAK ABS (BENDIX)	01-90		3243	K	28	23	58	48	I						
3.0i V6, 3.0i V6 BREAK	01-90		3352	K	28	27	57,7		I						
3.0i V6, 3.0i V6 BREAK ABS (BENDIX)	01-90		3244	K	28	27	58	48	I						
XSARA															
1.8i, 16V ABS Gear BE3 66/81 kW (90-110 HP)	07-97		3487	K	25	34	59	29	I						
1.9 DIESEL, TURBO DIESEL, ABS Gear BE3 50/66 kW (68-90 HP)	07-97		3487	K	25	34	59	29	I						
ZX															
1.6i w/ABS	03-91		3241	K	25	23	55,7	48	I						
1.9 TURBO DIESEL	07-92		3112	K	25	23	55,7		I						
1.9i, 2.0i, 2.0i 16V	03-91		3112	K	25	23	55,7		I						
TT GEAR BE1	03-91		3069	K	25	22	54,6		I						
TURBO DIESEL & INJ. ABS	03-91		3242	K	25	23	55,7	29	I						



	CHASSIS ↑	→ CHASSIS		G L O N .											
															
				XXXX	K	A	B	C	ABS	P	XXXX	K	A	B	C
DAEWOO															
CIELO															
1,5	80 HP		01-94		3272	K	22	29	51,8		E				
ESPERO															
1.8 CD, GL, GLX (Exc. JL9) M.T.	66/70 kW (90-95 HP)		05-92	03-95	3494	K	33	29	52		E				
1.8 GL, GLX A.T.	66/70 kW (90-95 HP)		03-95	07-95	3494	K	33	29	52		E				
1.8i CD			05-92		3305	K	33	29	51,8		E				
1.8i CD			09-95		3373	K	33	29	52	47	E				
2.0 CD, GL, GLX (Exc. JL9) M.T.	77 kW (105 HP)		05-92	03-95	3494	K	33	29	52		E				
2.0 GL, GLX A.T.	77 kW (105 HP)		03-95	07-95	3494	K	33	29	52		E				
2.0i CD			05-92		3305	K	33	29	51,8		E				
2.0i CD			09-95		3373	K	33	29	52	47	E				
LEMANS															
1,5			01-87		3272	K	22	29	51,8		E				
1,6			01-89		3272	K	22	29	51,8		E				
2.0			01-89		3272	K	22	29	51,8		E				
MATIZ															
0.8 ABS	38 kW (52 HP)		09-98		3472	K	23	19	46	40	E				
NEXIA															
1.5i			09-95		3272	K	22	29	51,8		E				
1.5i 16V			09-95		3272	K	22	29	51,8		E				
RACER															
1,5	80 HP		01-89	12-93	3272	K	22	29	51,8		E				
1,5	80 HP		01-94		3305	K	33	29	51,8		E				
1.8 CD, GL, GLX (Exc. JL9) M.T.	66/70 kW (90-95 HP)		05-92	03-95	3494	K	33	29	52		E				
1.8 GL, GLX A.T.	66/70 kW (90-95 HP)		03-95	07-95	3494	K	33	29	52		E				
2.0			01-89	12-93	3272	K	22	29	51,8		E				
2.0			01-94		3305	K	33	29	51,8		E				
2.0 CD, GL, GLX (Exc. JL9) M.T.	77 kW (105 HP)		05-92	03-95	3494	K	33	29	52		E				
2.0 GL, GLX A.T.	77 kW (105 HP)		03-95	07-95	3494	K	33	29	52		E				
TICO (ALGERIA)															
TT			05-92		3315	K	23	19	44		M				
TICO (BULGARIA)															
TT	(SNAP RING INSTALLED)		05-92		3236	K	23	19	44		E				



	CHASSIS →	→ CHASSIS		G L O N .														
				  				XXXX	K	A	B	C	ABS	P	XXXX	K	A	B

DAIHATSU

APPLAUSE																			
1.3			01-89	12-94	3216	K	24	22	54		M								
1.6			01-89	12-94	3216	K	24	22	54		M								
1.6 16V	77 kW (105 HP)		01-90		3216	K	24	22	54		M								
CHARADE (AUSTRALIA)																			
1.0 (G11-G30)	CB-CL10		10-83	03-87	3285	K	24	19	40		M								
1.0 D (G-30)	CL		10-83	03-87	3285	K	24	19	40		M								
1.0 T (G11-G30)	CB (Australia)		01-83	05-87	3285	K	24	19	40		M								
1.0 TURBO DIESEL	A.T./M.T. Mod. G30 Eng. CL 60 34 kW (46 HP)		02-85	03-87	3457	K	24	19	40		M								
CHARADE																			
1.0			10-89		3337	K	24	21	54		M								
1.0 A.T./M.T.	Mod. G11 Eng. CB 20 38 kW (52 HP)		10-83	03-87	3457	K	24	19	40		M								
1.0 D			10-89		3337	K	24	21	54		M								
1.0 DIESEL	A.T./M.T. Mod. G30 Eng. CL 10 27 kW (37 HP)		10-83	03-87	3457	K	24	19	40		M								
1.0 T			10-89		3337	K	24	21	54		M								
1.0 TURBO	A.T./M.T. Mod. G11 Eng. CB 60		10-83	03-87	3457	K	24	19	40		M								
75 LAC (USA)			01-88	12-92	3109	K	24	19	46		M								
G 100	CB		01-87	12-89	3109	K	24	19	46		M								
G 100 M.T. (NO GT)	CB		01-87		3109	K	24	19	46		M								
G 101	Eng. CL		03-87	03-89	3109	K	24	19	46		M								
G 102 (R)	HC		01-88	12-89	3109	K	24	19	46		M								
G 102 (L)	HC 1300 (A.T.)		01-89		3337	K	24	21	54		M								
G 102 (L)	HC 1300 (M.T.)		01-89		3337	K	24	21	54		M								
G 102 (R)	HC 1300 (A.T.)		01-89		3260	K	24	19	54		M								
G 102 (R)	HC 1300 (M.T.)		01-89		3260	K	24	19	54		M								
NEW G 100	CB 1000(A.T./M.T.)		01-89	12-90	3260	K	24	19	54		M								
CUORE - MIRA																			
L200S - L200V	EFCL-EFHL (M.T.)		01-92		3324	K	24	20	44		I								
L201	ED		01-90	12-95	3324	K	24	20	44		I								
L70V - L70S	EB550		01-85	12-90	3195	K	24	19	44		M								
L70V - L70S	EB550 (A.T.)		01-87	01-88	3195	K	24	19	44		M								
KANCIL																			
TT			01-90		3324	K	24	20	44		I								

DATSUN → NISSAN



CHASSIS ↑

→ CHASSIS

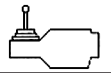

**G L O N .**

XXXX K A B C ABS P XXXX K A B C

DODGE (CHRYSLER)

Model		Design	Start	End	Code	K	A	B	C	ABS	P	XXXX	K	A	B	C
ARIES																
2,2	CITROEN DESIGN		05-83	12-85	3027		26	23	54		I					
2,2	GKN DESIGN		05-83	12-83	3042		26	22	54		I					
2,2	ACI DESIGN		01-84	12-88	3065		26	28	54		I					
2,2	GKN DESIGN		01-84	12-86	3040		26	22	54		I					
2,2	SAGINAW DESIGN		01-86	12-88	3066		26	29	54		E					
2,2	GKN-1 DESIGN		01-87	12-87	3521	K	26	23	54		I					
2,2	GKN-2 DESIGN		01-87	12-87	3117	K	26	32	54		I					
2,5	CITROEN DESIGN		01-86	12-86	3027		26	23	54		I					
2,5	GKN DESIGN		01-86	12-86	3521	K	26	23	54		I					
2,5	SAGINAW DESIGN		01-86	12-88	3066		26	29	54		E					
2,5	GKN DESIGN		01-88	12-88	3117	K	26	32	54		I					
2,6	CITROEN DESIGN		01-84	12-85	3027		26	23	54		I					
2,6	GKN DESIGN		01-85	12-85	3521	K	26	23	54		I					
TT	CITROEN DESIGN		01-81	12-82	3027		26	23	54		I					
TT	GKN DESIGN		01-81	12-82	3521	K	26	23	54		I					
TT	ACI DESIGN		01-89	12-89	3065		26	28	54		I					
TT	GKN DESIGN		01-89	12-89	3117	K	26	32	54		I					
TT	SAGINAW DESIGN		01-89	12-89	3066		26	29	54		E					
TT (NO 2.2 05/83>)	CITROEN DESIGN		01-83	12-83	3027		26	23	54		I					
TT (NO 2.2 05/83>)	GKN DESIGN		01-83	12-83	3521	K	26	23	54		I					
TT ABS	SAGINAW DESIGN		01-89	12-89	3159		26	29	54	47	E					
CARAVAN & RAM VAN, GRAND CARAVAN & CARAVAN C/V (FWD), VOYAGER																
2.5 A.T.	GKN DESIGN		01-92	12-93	3136		26	30	54		I					
4 CYL, A.T.			01-91	12-91	3117	K	26	32	54		I					
4 CYL, M.T.			01-92	12-92	3117	K	26	32	54		I					
4 CYL, M.T. (DX)			01-91	12-91	3117	K	26	32	54		I					
4 CYL, M.T. (SX)			01-91	12-91	3128	K	26	32	54		E					
TT			01-84	12-86	3027		26	23	54		I					
TT	CITROEN DESIGN		01-87	12-87	3027		26	23	54		I					
TT	GKN DESIGN		01-87	12-87	3117	K	26	32	54		I					
TT			01-88	12-90	3117	K	26	32	54		I					
TT			01-91	12-91	3117	K	26	32	54		I					
TT ABS			01-91	12-91	3158	K	26	32	54	47	I					
V-6			01-91	12-92	3117	K	26	32	54		I					
V-6 ABS			01-92	12-92	3158	K	26	32	54	47	I					
COLT VISTA																
4WD WAGON	Mod.100 LAC		88	91	3456	K	25	26	54		I					
COLT (NO VISTA)																
1,5			93	95	3458	K	25	22	54		M					
TT			01-79	12-83	3044	K	25	22	50		M					
TT			01-89	12-92	3261	K	25	22	50		I					
TT (NO TURBO)			01-84	12-86	3044	K	25	22	50		M					
TT (NO TURBO)			01-87	12-88	3261	K	25	22	50		I					
DAYTONA																
2,2	ACI DESIGN		01-86	12-87	3065		26	28	54		I					

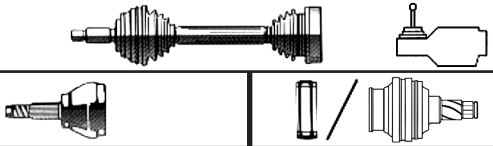

	CHASSIS →	→ CHASSIS		G L O N .									
													
				XXXX	K	A	B	C	ABS	P	XXXX	K	A

DODGE (CHRYSLER)

2.2	GKN DESIGN			01-86	12-86	3040		26	22	54		I							
2.2	SAGINAW DESIGN			01-86	12-87	3066		26	29	54		E							
2.2	CITROEN DESIGN			01-87	12-87	3027		26	23	54		I							
2.2 (NO TURBO)	ACI DESIGN			01-84	12-85	3065		26	28	54		I							
2.2 (NO TURBO)	CITROEN DESIGN			01-84	12-85	3027		26	23	54		I							
2.2 (NO TURBO)	GKN DESIGN			01-84	12-85	3040		26	22	54		I							
2.2 TURBO	CITROEN DESIGN			01-84	12-86	3027		26	23	54		I							
2.2 TURBO	SAGINAW DESIGN			01-86	12-86	3066		26	29	54		E							
2.5	CITROEN DESIGN			01-86	12-86	3027		26	23	54		I							
2.5	GKN DESIGN			01-86	12-86	3521	K	26	23	54		I							
2.5	SAGINAW DESIGN			01-86	12-87	3066		26	29	54		E							
2.5	GKN-1 DESIGN			01-87	12-87	3521	K	26	23	54		I							
2.5	GKN-2 DESIGN			01-87	12-87	3117	K	26	32	54		I							
2.5 A.T. (NO TURBO)				01-91	12-92	3066		26	29	54		E							
2.5 A.T. (NO TURBO), ABS				01-91	12-92	3159		26	29	54	47	E							
TT	SAGINAW DESIGN			01-88	12-90	3066		26	29	54		E							
TT (NO 2.5 NON-TURBO, A.T. & '92 2.2 TURBO)				01-91	12-92	3128	K	26	32	54		E							
TT (NO 2.5 NON-TURBO, A.T. & '92 2.2 TURBO), ABS				01-91	12-92	3160	K	26	32	54	47	E							
TT (NO TURBO)	GKN DESIGN			01-88	12-90	3117	K	26	32	54		I							
TT ABS	SAGINAW DESIGN			01-88	12-90	3159		26	29	54	47	E							
TT TURBO	GKN DESIGN			01-88	12-90	3117	K	26	32	54		I							
DYNASTY																			
4 CYL				01-91	12-92	3066		26	29	54		E							
4 CYL, ABS				01-91	12-92	3159		26	29	54	47	E							
TT	GKN DESING			01-88	12-90	3117	K	26	32	54		I							
TT	SAGINAW DESIGN			01-88	12-90	3066		26	29	54		E							
TT ABS	GKN DESING			01-88	12-90	3158	K	26	32	54	47	I							
V-6				01-91	12-92	3128	K	26	32	54		E							
LANCER																			
2.2	ACI DESIGN			01-86	12-88	3065		26	28	54		I							
2.2	GKN DESIGN			01-86	12-86	3040		26	22	54		I							
2.2	SAGINAW DESIGN			01-86	12-88	3066		26	29	54		E							
2.2	CITROEN DESING			01-87	12-87	3027		26	23	54		I							
2.2	GKN DESIGN			01-88	12-88	3117	K	26	32	54		I							
2.2 TURBO	CITROEN DESIGN			01-86	12-86	3027		26	23	54		I							
2.5	CITROEN DESIGN			01-86	12-86	3027		26	23	54		I							
2.5	GKN DESIGN			01-86	12-86	3521	K	26	23	54		I							
2.5	SAGINAW DESIGN			01-86	12-88	3066		26	29	54		E							
2.5	GKN-1 DESIGN			01-87	12-87	3521	K	26	23	54		I							
2.5	GKN-2 DESIGN			01-87	12-87	3117	K	26	32	54		I							
2.5	GKN DESIGN			01-88	12-88	3117	K	26	32	54		I							
TT	CITROEN DESIGN			01-85	12-85	3027		26	23	54		I							
TT	GKN DESIGN			01-89	12-89	3117	K	26	32	54		I							
TT	SAGINAW DESIGN			01-89	12-89	3066		26	29	54		E							
TT (NO TURBO)	ACI DESIGN			01-85	12-85	3065		26	28	54		I							
TT (NO TURBO)	GKN DESIGN			01-85	12-85	3040		26	22	54		I							



CHASSIS ↑

→ CHASSIS



G L O N .

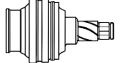
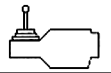
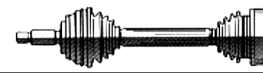

XXXX	K	A	B	C	ABS	P	XXXX	K	A	B	C
------	---	---	---	---	-----	---	------	---	---	---	---

DODGE (CHRYSLER)

TT (NO TURBO)	ACI DESIGN			01-89	12-89	3065		26	28	54		I							
TT ABS	SAGINAW DESIGN			01-89	12-89	3159		26	29	54	47	E							
MONACO																			
2.5 TURBO, M.T., ABS				01-90	12-91	3117	K	26	32	54		I							
OMNI, CHARGER & 024, MISER & SHELBY																			
1.6				05-83	12-83	3042		26	22	54		I							
1.7				01-81	12-83	3025		26	23	54		I							
2.2				05-83	12-83	3042		26	22	54		I							
2.2				01-81	12-83	3521	K	26	23	54		I							
2.2 SPECIAL HIGH OUTPUT				01-85	12-86	3027		26	23	54		I							
TT				01-79	12-80	3024		26	23	60		I							
TT				01-84	12-84	3042		26	22	54		I							
TT (NO SPECIAL HIGH OUTPUT & TURBO)				01-85	12-86	3042		26	22	54		I							
TT A.T.	GKN DESIGN			01-87	12-90	3042		26	22	54		I							
TT A.T.	ACI DESIGN			01-88	12-90	3065		26	28	54		I							
TT M.T.				01-88	12-90	3042		26	22	54		I							
TT M.T. (NO TURBO)				01-87	12-87	3042		26	22	54		I							
TURBO				01-85	12-86	3027		26	23	54		I							
TURBO M.T.				01-87	12-87	3027		26	23	54		I							
RAMPAGE																			
TT				01-82	05-83	3521	K	26	23	54		I							
TT				05-83	12-84	3042		26	22	54		I							
SHADOW																			
2,2	SAGINAW DESIGN			01-88	12-88	3066		26	29	54		E							
2,2	ACI DESIGN			01-88	12-88	3065		26	28	54		I							
2,2	GKN DESIGN			01-88	12-88	3117	K	26	32	54		I							
2,5	GKN DESIGN			01-88	12-88	3117	K	26	32	54		I							
2,5	SAGINAW DESIGN			01-88	12-88	3066		26	29	54		E							
TT	ACI DESIGN			01-87	12-87	3065		26	28	54		I							
TT	CITROEN DESING			01-87	12-87	3027		26	23	54		I							
TT	SAGINAW DESIGN			01-87	12-87	3066		26	29	54		E							
TT	GKN DESIGN			01-89	12-90	3117	K	26	32	54		I							
TT	SAGINAW DESIGN			01-89	12-90	3066		26	29	54		E							
TT (NO TURBO)	ACI DESIGN			01-89	12-90	3065		26	28	54		I							
TT A.T. (NO TURBO)				01-91	12-92	3066		26	29	54		E							
TT A.T. (NO TURBO), ABS				01-91	12-92	3159		26	29	54	47	E							
TT ABS	SAGINAW DESIGN			01-89	12-90	3159		26	29	54	47	E							
TT M.T.				01-91	12-92	3128	K	26	32	54		E							
TT M.T. , ABS				01-91	12-92	3160	K	26	32	54	47	E							
SPIRIT																			
2.2 TURBO III	ACI DESIGN			01-92	12-93	3136		26	30	54		I							
2.2 TURBO III ABS	ACI DESIGN			01-92	12-92	3137		26	30	54	47	I							
2.5	ACI DESIGN			01-92	12-93	3136		26	30	54		I							
2.5 ABS	ACI DESIGN			01-92	12-93	3137		26	30	54	47	I							
2.5 TC TURBO A.T.	ACI DESIGN			01-92	12-92	3136		26	30	54		I							
2.5 TC TURBO A.T. ABS	ACI DESIGN			01-92	12-92	3137		26	30	54	47	I							



	CHASSIS →	→ CHASSIS		G L O N .											
				XXXX	K	A	B	C	ABS	P	XXXX	K	A	B	C

DODGE (CHRYSLER)

2.5 TURBO			01-93	12-93	3136		26	30	54		I					
2.5 TURBO ABS	ACI DESIGN		01-93	12-93	3137		26	30	54	47	I					
3.0 A.T.	ACI DESIGN		01-92	12-93	3136		26	30	54		I					
3.0 A.T. ABS	ACI DESIGN		01-92	12-92	3137		26	30	54	47	I					
TT			01-87	12-90	3388	K	26	24	56		I					
TT	GKN DESIGN		01-89	12-90	3117	K	26	32	54		I					
TT	SAGINAW DESIGN		01-89	12-90	3066		26	29	54		E					
TT A.T.			01-91	12-91	3117	K	26	32	54		I					
TT A.T. ABS			01-91	12-91	3158	K	26	32	54	47	I					
TT ABS	SAGINAW DESIGN		01-89	12-90	3159		26	29	54	47	E					
TT M.T. (DX)			01-91	12-91	3117	K	26	32	54		I					
TT M.T. (SX)			01-91	12-91	3128	K	26	32	54		E					
TT M.T. , ABS (DX)			01-91	12-91	3158	K	26	32	54	47	I					
400 & 600																
2.2	GKN DESIGN		05-83	12-83	3042		26	22	54		I					
2.2	SAGINAW DESIGN		01-86	12-88	3066		26	29	54		E					
2.2	ACI DESIGN		01-87	12-88	3065		26	28	54		I					
2.2	CITROEN DESIGN		01-87	12-87	3027		26	23	54		I					
2.2	GKN DESIGN		01-88	12-88	3117	K	26	32	54		I					
2.2 (NO TURBO)	ACI DESIGN		01-84	12-86	3065		26	28	54		I					
2.2 (NO TURBO)	CITROEN DESIGN		01-84	12-85	3027		26	23	54		I					
2.2 (NO TURBO)	GKN DESIGN		01-84	12-86	3040		26	22	54		I					
2.2 ABS	SAGINAW DESIGN		01-86	12-88	3159		26	29	54	47	E					
2.2 TURBO	CITROEN DESIGN		01-84	12-86	3027		26	23	54		I					
2.5	CITROEN DESIGN		01-86	12-86	3027		26	23	54		I					
2.5	GKN DESIGN		01-86	12-86	3521	K	26	23	54		I					
2.5	SAGINAW DESIGN		01-86	12-88	3066		26	29	54		E					
2.5	GKN-1 DESIGN		01-87	12-87	3521	K	26	23	54		I					
2.5	GKN-2 DESIGN		01-87	12-87	3117	K	26	32	54		I					
2.5	GKN DESIGN		01-88	12-88	3117	K	26	32	54		I					
2.5 ABS	SAGINAW DESIGN		01-86	12-88	3159		26	29	54	47	E					
2.6			01-84	12-84	3027		26	23	54		I					
2.6	CITROEN DESIGN		01-85	12-85	3027		26	23	54		I					
2.6			01-85	12-85	3521	K	26	23	54		I					
TT	CITROEN DESIGN		01-82	12-82	3027		26	23	54		I					
TT	GKN DESIGN		01-82	12-82	3521	K	26	23	54		I					
TT	CITROEN DESIGN		01-83	12-83	3027		26	23	54		I					
TT (NO 2.2 05/83>)	GKN DESIGN		01-83	12-83	3521	K	26	23	54		I					



CHASSIS ↑

→ CHASSIS

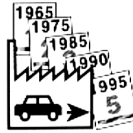

G L O N .

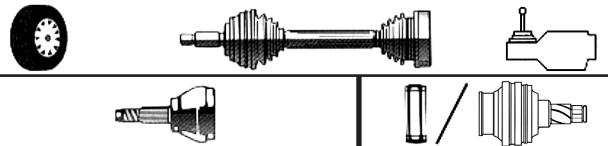

XXXX	K	A	B	C	ABS	P	XXXX	K	A	B	C
------	---	---	---	---	-----	---	------	---	---	---	---

EAGLE

SUMMIT

Model	Mod.	93	95	XXXX	K	A	B	C	ABS	P	XXXX	K	A	B	C
1.5 (Exc. Wagon)	Mod. 82AC	93	95	3458	K	25	22	54		M					

FEAB

Model	XXXX	K	A	B	C	ABS	P	XXXX	K	A	B	C
JASTER 315	3115	K	18	18	42		E	4015	K	18	18	62







FERRARI

Model	XXXX	K	A	B	C	ABS	P	XXXX	K	A	B	C
F355 GTB, GTS, SPIDER (differential gear side)								4302	K		28	108

FIAT

Model	Power	Code	93	95	XXXX	K	A	B	C	ABS	P	XXXX	K	A	B	C
BARCETTA																
1.8 16V ABS M.T.	96 kW (130 HP)	43319	05-99		3344	K	25	25	52		E	4345	K		25	100
1.8i 16V	96 kW (131 HP)		09-95		3706	K	25	25	52		I	4345	K		25	100
1.8i 16V ABS	96 kW (131 HP)		04-95		3673	K	25	25	52	44	I	4345	K		25	100
BRAVO - BRAVA (M.T.)																
1.4i 12V	55 kW (75 HP)		09-95		3667	K	22	20	46		E					
1.4i 12V ABS	55 kW (75 HP)		09-95		3168	K	22	20	46	44	E					
1.6	66 kW (90 HP)		06-95	10-95	3667	K	22	20	46		E					
1.6	66 kW (90 HP)		10-95		3316	K	22	22	46		E					
1.6 ABS	66 kW (90 HP)		06-95	10-95	3168	K	22	20	46	44	E					
1.6 ABS	66 kW (90 HP)		10-95		3317	K	22	22	46	44	E					
1.8i 16V GT	83 kW (113 HP)		09-95		3706	K	25	25	52		I	4345	K		25	100
1.8i 16V GT ABS	83 kW (113 HP)		09-95		3673	K	25	25	52	44	I	4345	K		25	100
1.9 DIESEL	48 kW (65 kW)		09-95		3667	K	22	20	46		E					



	CHASSIS →	→ CHASSIS		G L O N .											
								XXXX	K	A	B	C	ABS	P	XXXX

FIAT

1.9 DIESEL ABS	48 kW (65 kW)		09-95		3168	K	22	20	46	44	E							
BRAVO - BRAVA (A.T.)																		
1.6	66 kW (90 HP)		06-95	10-95	3667	K	22	20	46		E							
1.6	66 kW (90 HP)		10-95		3316	K	22	22	46		E							
1.6 ABS	66 kW (90 HP)		06-95	10-95	3168	K	22	20	46	44	E							
1.6 ABS	66 kW (90 HP)		10-95		3317	K	22	22	46	44	E							
BRAVO - BRAVA																		
1.9 TD	55/74 kW (75-100 HP)		96	98	3344	K	25	25	52		E							
1.9 TD ABS	55/74 kW (75-100 HP)		96	98	3345	K	25	25	52	44	E							
105 1.9 JTD	77 kW (105 HP)		12-98		3344	K	25	25	52		E	4345	K		25	100		
75-100 S 1.9 TURBO DIESEL	55/74 kW (75-101 HP)		98		3344	K	25	25	52		E	4345	K		25	100		
80 1.2 16V	60 kW (82 HP)		98		3492	K	22	20	51		E	4345	K		25	100		
BRAVA																		
100 1.6 16V (Inc. Turkey, Brazil)	76 kW (103 HP)		04-99		3490	K	25	22	51		E	4345	K		25	100		
BRAVO																		
HGT 20V ABS			09-95		3318	K	25	25	59	44	E	4345	K		25	100		
100 1.6 16V (Inc. Brazil)	76 kW (103 HP)		04-99		3490	K	25	22	51		E	4345	K		25	100		
CAMPAGNOLA																		
TORPEDO 1197 AD 1C 1, 5C 1					4512	K		25	100			4512	K		25	100		
CINQUECENTO																		
700 CC	23 kW (31 HP)		07-94		3129	K	22	20	46		E							
900 CC	30 kW (41 HP)		07-91		3129	K	22	20	46		E							
COUPE'																		
1,8			01-96		3706	K	25	25	52		I							
1.8 ABS			01-96		3673	K	25	25	52	44	I							
2.0 16V			01-96		3706	K	25	25	52		I							
2.0 16V ABS	102kW		03-94		3673	K	25	25	52	44	I							
2.0 TURBO ABS	140kW		03-94		3252	K	25	28	56	44	E							
CROMA (M.T.)																		
1.6	61/63 kW (83-85)		12-85	12-91	3706	K	25	25	52		I	4512	K		25	100		
2.0	66/89 kW (90-120 HP)		0189806	12-85	3706	K	25	25	52		I	4512	K		25	100		
2.0	72/89 kW (98-120 HP)	0189807		01-93	3706	K	25	25	52		I	4512	K		25	100		
2.0 ABS	66/89 kW (90-120 HP)		0189806	12-85	3671	K	25	25	52	90	I	4512	K		25	100		
2.0 ABS	74/87 kW (100-119 HP)			01-93	3673	K	25	25	52	44	I							
2.0 ABS	72/89 kW (98-120 HP)	0189807		01-93	3671	K	25	25	52	90	I	4512	K		25	100		
2.0 IE			11-92		3245	K	27	25	56		I							
2.0 IE ABS			11-92		3246	K	27	25	56	44	I							
2.0 TURBO	110/114 kW (150-155 HP)		0189806	12-85	3706	K	25	25	52		I	4512	K		25	100		
2.0 TURBO	110/116 kW (150-158 HP)	0189807		01-93	3706	K	25	25	52		I	4512	K		25	100		
2.0 TURBO ABS	110/114 kW (150-155 HP)		0189806	12-85	3671	K	25	25	52	90	I	4512	K		25	100		
2.0 TURBO ABS	110/116 kW (150-158 HP)			01-93	3673	K	25	25	52	44	I							
2.0 TURBO ABS	110/116 kW (150-158 HP)	0189807		01-93	3671	K	25	25	52	90	I	4512	K		25	100		
2.0 TURBO I.E.			11-92		3245	K	27	25	56		I							
2.0 TURBO I.E. ABS			11-92		3246	K	27	25	56	44	I							
2.5 V6			11-92		3245	K	27	25	56		I							
2.5 V6 ABS			11-92		3246	K	27	25	56	44	I							



CHASSIS ↑

→ CHASSIS

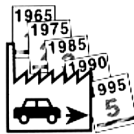

G L O N .

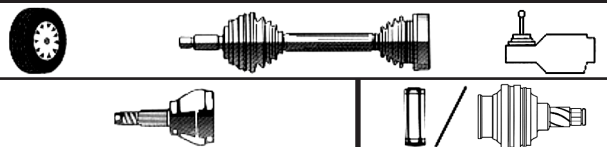

XXXX	K	A	B	C	ABS	P	XXXX	K	A	B	C
------	---	---	---	---	-----	---	------	---	---	---	---

FIAT

CHT			01-92		3706	K	25	25	52		I					
CHT, I.E., TURBO I.E.			12-85		3706	K	25	25	52		I	4512	K		25	100
CROMA DIESEL (M.T.)																
1.9 TURBO DIESEL	66/68 kW (90-92 HP)		0189806	01-88												
1.9 TURBO DIESEL	66/68 kW (90-92 HP)	0189807		01-93	3706	K	25	25	52		I	4512	K		25	100
1.9 TURBO DIESEL ABS	66/68 kW (90-92 HP)		0189806	01-88	3671	K	25	25	52	90	I	4512	K		25	100
1.9 TURBO DIESEL ABS	66/68 kW (90-92 HP)	0189807		01-93	3671	K	25	25	52	90	I	4512	K		25	100
2.0 TURBO DIESEL	68/69 kW (92-94 HP)			01-93	3706	K	25	25	52		I					
2.5 D	55 kW (75 HP)		0189806	12-85	3706	K	25	25	52		I	4512	K		25	100
2.5 D	55 kW (75 HP)	0189807		12-92	3706	K	25	25	52		I	4512	K		25	100
2.5 D ABS	55 kW (75 HP)		0189806	12-85	3671	K	25	25	52	90	I	4512	K		25	100
2.5 D ABS	55 kW (75 HP)	0189807		12-92	3671	K	25	25	52	90	I	4512	K		25	100
2.5 TURBO DIESEL	85/87 kW (115-118 HP)		0189806	12-85	3706	K	25	25	52		I	4512	K		25	100
2.5 TURBO DIESEL				11-92	3245	K	27	25	56		I					
2.5 TURBO DIESEL	85/87 kW (115-118 HP)	0189807		01-93	3706	K	25	25	52		I	4512	K		25	100
2.5 TURBO DIESEL ABS	85/87 kW (115-118 HP)		0189806	12-85	3671	K	25	25	52	90	I	4512	K		25	100
2.5 TURBO DIESEL ABS				11-92	3246	K	27	25	56	44	I					
2.5 TURBO DIESEL ABS	85/87 kW (115-118 HP)			01-93	3673	K	25	25	52	44	I	4512	K		25	100
2.5 TURBO DIESEL ABS	85/87 kW (115-118 HP)	0189807		01-93	3671	K	25	25	52	90	I	4512	K		25	100
DUCATO																
18 Q ABS		5235558		94	3465	K	35	45	70	54	I					
DUCATO 280 (M.T.)																
1,8	49kW			01-82	10-88	3076	K	28	27	63		I				
2.0	58kW			01-82	07-90	3076	K	28	27	63		I				
2.0	55kW			07-85	12-93	3076	K	28	27	63		I				
2.0	62kW			01-90	03-94	3076	K	28	27	63		I				
COMBINATO				01-82	12-93	3076	K	28	27	63		I				
PANORAMA				01-82	12-93	3076	K	28	27	63		I				
DUCATO 280 DIESEL (M.T.)																
1.9 D	52kW			02-87	03-94	3076	K	28	27	63		I				
1.9 D	60kW			03-89	03-94	3076	K	28	27	63		I				
1.9 TURBO DIESEL	60kW			03-89	03-94	3076	K	28	27	63		I				
2.5 D	55kW			01-82	03-94	3076	K	28	27	63		I				
2.5 D (4x4)	55kW			01-87	03-94	3076	K	28	27	63		I				
2.5 TURBO DIESEL	68kW			01-87	08-90	3076	K	28	27	63		I				
2.5 TURBO DIESEL (4x4)	68kW			01-86	12-91	3076	K	28	27	63		I				
DUCATO 290 (M.T.)																
2.0	62kW			07-90	03-94	3076	K	28	27	63		I				
DUCATO 290 DIESEL (M.T.)																
1.9 D	52kW			07-90	03-94	3076	K	28	27	63		I				
1.9 TURBO DIESEL	60kW			03-89	03-94	3076	K	28	27	63		I				
2.5 D	55kW			07-90	03-94	3076	K	28	27	63		I				
2.5 D (4x4)	55kW			07-90	03-94	3076	K	28	27	63		I				
2.5 TURBO DIESEL	70kW			07-90	03-94	3076	K	28	27	63		I				
2.5 TURBO DIESEL (4x4)	70kW			07-90	03-94	3076	K	28	27	63		I				

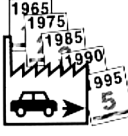

		CHASSIS →	→ CHASSIS		G L O N .											
					XXXX	K	A	B	C	ABS	P	XXXX	K	A	B	C
FIAT																
NUOVO DUCATO 230 (M.T.)																
NUOVO DUCATO	1.0, 1.4 TONS			03-94		3353	K	28	39	63		I				
NUOVO DUCATO	1.8 TONS			03-94		3278	K	35	45	70		I				
NUOVO DUCATO ABS	1.0, 1.4 TONS			03-94		3253	K	28	39	63	54	I				
NUOVO DUCATO ABS	1.8 TONS			03-94		3254	K	35	45	70	54	I				
DUNA																
1,3	43 kW (58 HP)			01-87	12-90	3504	K	22	20	48		E				
1,3	50 kW (67 HP)			01-87	12-91	3504	K	22	20	48		E				
TT				03-88		3504	K	22	20	48		E				
DUNA DIESEL																
1.7 D	44 kW (60 HP)			01-87	12-91	3504	K	22	20	48		E				
DUNA STATION WAGON																
1.1 WEEKEND 60	43 kW (58 HP)			01-87	12-91	3504	K	22	20	48		E				
1.3 WEEKEND 70	50 kW (67 HP)			01-87	12-91	3504	K	22	20	48		E				
1.7 DIESEL WEEKEND	44 kW (60 HP)			01-87	12-91	3504	K	22	20	48		E				
ELBA (BRAZIL)																
1.3, 1.5, 1.6				01-86		3504	K	22	20	48		E				
FIORINO - FIORINO UNO																
0.9	30/35 kW (40-47 HP)		8817481	03-71	02-80	3501	K	20	20	43,1		E				
0.9	30/35 kW (40-47 HP)	8817482		03-80	12-87	3504	K	22	20	48		E				
0.9, 1.05 RESTYLING						3501	K	20	20	43,1		E				
1.05	37 kW (50 HP)			06-78	02-80	3501	K	20	20	43,1		E				
1.05	37 kW (50 HP)			03-80	12-87	3504	K	22	20	48		E				
1.1-1.3-1.5 / 1.3-1.5 DIESEL				03-71	12-93	3504	K	22	20	48		E				
147 (SOUTH AMERICA)				03-80	12-87	3504	K	22	20	48		E				
UNO (1.4-1.6-1.7 DIESEL)				01-88	12-93	3504	K	22	20	48		E				
UNO (1.4-1.6-1.7 DIESEL)				01-94		3336	K	22	20	52		E				
FIORINO																
1.7 TURBO DIESEL	46 kW (62 HP)			01-96		3363	K	22	22	52		E				
1.7 TURBO DIESEL ABS	46 kW (62 HP)			01-96		3364	K	22	22	52	44	E				
60 1.1	40 kW (54 HP)			05-88	12-93	3501	K	20	20	43,1		E				
60 DIESEL 1.7	42/44 kW (57-60 HP)			05-88		3504	K	22	20	48		E				
70 1.4	49 kW (66 HP)			10-89		3501	K	20	20	43,1		E				
75i.e. 1.5	55 kW (75 HP)			05-88	12-93	3501	K	20	20	43,1		E				
MAREA - MAREA WEEKEND (M.T.-A.T.)																
1.6 16V	76 kW (103 HP)			09-96		3342	K	25	22	52		E	4345	K	25	100
1.6 16V ABS	76 kW (103 HP)			09-96		3343	K	25	22	52	44	E	4345	K	25	100
100 1.6 16v, Bipower, A.T.	76 kW (103 HP)			04-99		3490	K	25	22	51		E	4345	K	25	100
MAREA - MAREA WEEKEND (M.T.)																
1.4 12V				09-96		3667	K	22	20	46		E	4345	K	25	100
1.4 12V ABS				09-96		3168	K	22	20	46	44	E	4345	K	25	100
1.8	83 kW (113 HP)			09-96	03-99	3344	K	25	25	52		E	4345	K	25	100
1.8 16V ABS	83 kW (113 HP)			09-96		3345	K	25	25	52	44	E				
1.8 16V	Mod. 115 83 kW (113 HP)			04-99		3344	K	25	25	52		E				
1.8 ABS	83 kW (113 HP)			09-96	03-99	3345	K	25	25	52	44	E	4345	K	25	100
1.8i 16V	83 kW (113 HP)			09-96		3344	K	25	25	52		E				



CHASSIS ↑

→ CHASSIS

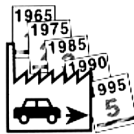

G L O N .

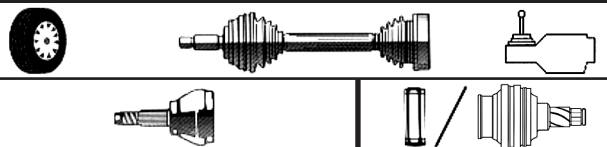

XXXX	K	A	B	C	ABS	P	XXXX	K	A	B	C
------	---	---	---	---	-----	---	------	---	---	---	---

FIAT

1.9 JTD	Mod. 105 77 kW (105 HP)			04-99		3344	K	25	25	52		E					
1.9 TURBO DIESEL	Mod. 75-100 55/74 kW (75-101 HP)			09-96	03-99	3344	K	25	25	52		E	4345	K		25	100
1.9 TURBO DIESEL	Mod. 75 55 kW (75 HP)			04-99		3344	K	25	25	52		E					
1.9 TURBO DIESEL ABS	Mod.75-100 55/74 kW (75-101 HP)			09-96	03-99	3345	K	25	25	52	44	E	4345	K		25	100
1.9 TURBO DIESEL, 1.9 TURBO DIESEL SOFT				09-96		3344	K	25	25	52		E					
1.9 TURBO DIESEL, 1.9 TURBO DIESEL SOFT ABS				09-96		3345	K	25	25	52	44	E	4345	K		25	100
2.0 20V	108 kW (147 HP)			09-96		3344	K	25	25	52		E	4345	K		25	100
2.0 20V ABS	108 kW (147 HP)			09-96		3318	K	25	25	59	44	E	4345	K		25	100
2.4 TURBO DIESEL	91 kW (124 HP)			09-96		3346	K	25	28	56		E	4345	K		25	100
2.4 TURBO DIESEL ABS	91 kW (124 HP)			09-96		3252	K	25	28	56	44	E	4345	K		25	100
MARENGO																	
1.9 D						3504	K	22	20	48		E					
MULTIPLA																	
1.6 16V	Mod.100 70/76 kW (95-103)			04-99		3490	K	25	22	51		E	4345	K		25	100
1.9 JTD	Mod.105 77 kW (105 HP)			04-99		3344	K	25	25	52		E	4345	K		25	100
OGGI (BRAZIL)																	
1.05, 1.3				01-83	12-85	3501	K	20	20	43,1		E					
PALIO																	
1.0 ED 3P				01-96		3336	K	22	20	52		E					
1.0 EDX 3P				01-96		3336	K	22	20	52		E					
1.0 EDX 5P				01-96		3336	K	22	20	52		E					
1.5				01-96		3363	K	22	22	52		E					
PALIO - PALIO WEEKEND																	
1.2, 1.2 S.W.	54 kW (73 HP)			4628927	01-96	3336	K	22	20	52		E					
1.6				01-96		3363	K	22	22	52		E					
1.6 ABS						3364	K	22	22	52	44	E					
PALIO - PALIO WEEKEND DIESEL																	
1.7 DIESEL	51 kW (69 HP)			07-98		3363	K	22	22	52		E					
PANDA																	
30	650, 750 CC			01-80		3501	K	20	20	43,1		E					
34	850 CC			01-80		3501	K	20	20	43,1		E					
45	900, 1000 CC			01-80		3501	K	20	20	43,1		E					
PANDA DIESEL																	
1.3 D	27 kW (37 HP)			04-86		3501	K	20	20	43,1		E					
PANDA 4x4																	
TT	965 CC			06-83	12-85	3501	K	20	20	43,1		E					
TT	1000 CC			01-86		3501	K	20	20	43,1		E					
PANORAMA (BRAZIL)																	
1.05,1.3				80	86	3501	K	20	20	43,1		E					
PREMIO (BRAZIL)																	
1,6				01-90		3504	K	22	20	48		E					
1,3, 1,5				01-85		3504	K	22	20	48		E					
PUNTO																	
1.2 8V, 12V 6,7-Speedgear M.T.	44/59 kW (60-80 HP)			08-99		3482	K	22	21	51		M	4345	K		25	100
1.4 TURBO, GT	(133 HP)			09-93		3706	K	25	25	52		I	4345	K		25	100
1.4 TURBO, GT, ABS	(133 HP)			09-93		3673	K	25	25	52	44	I	4345	K		25	100



		CHASSIS →	→ CHASSIS		G L O N .												
					XXXX	K	A	B	C	ABS	P	XXXX	K	A	B	C	
FIAT																	
1.7 DIESEL	46 kW (62 HP)			01-98	3316	K	22	22	46		E						
1.7 TURBO DIESEL	52/53 kW (71-72 HP)			09-93	3706	K	25	25	52		I						
1.7 TURBO DIESEL ABS	52/53 kW (72-73 HP)			09-93	3673	K	25	25	52	44	I						
1.8 16V HGT	96 kW (130 HP)			08-99	3344	K	25	25	52		E	4345	K		25	100	
1.9 DIESEL	44 kW (60HP)			08-99	3482	K	22	21	51		M	4345	K		25	100	
1.9 JTD	59 kW (80 HP)			08-99	3344	K	25	25	52		E	4345	K		25	100	
55 (1.1)	40 kW (55 HP)			09-93	3667	K	22	20	46		E						
55 (1.1 ABS)	40 kW (55 HP)			09-93	3168	K	22	20	46	44	E						
60 (1.2 ABS)	43/44 kW			09-93	3168	K	22	20	46	44	E						
60 (1.2 S ABS)	44 kW(CABRIO)			05-94	3168	K	22	20	46	44	E						
60 (1.2)	43/44 kW			09-93	3667	K	22	20	46		E						
75 (1.2 ABS)	54 kW			09-93	3168	K	22	20	46	44	E						
75 (1.2)	54 kW			09-93	3667	K	22	20	46		E						
90 (1.6 ABS)	65 kW			09-93	3168	K	22	20	46	44	E						
90 (1.6)	65 kW			09-93	3667	K	22	20	46		E						
90 (1.6 ELX ABS)	65 kW(CABRIO)			05-94	3168	K	22	20	46	44	E						
REGATA (A.T.)																	
1,5	55/61 kW (75-82 HP)			03-83	12-90	3012	K	22	25	48		I	4511	K		33	94
REGATA (M.T.)																	
1.3	48/55 kW (65-75 HP)			09-83	12-90	3504	K	22	20	48		E					
1.5	55/61 kW (75-82 HP)			09-83	12-90	3012	K	22	25	48		I					
1.6	105 HP			09-83	12-90	3012	K	22	25	48		I	4512	K		25	100
1.6	66/77 kW (90-105 HP)			09-83	12-90	3012	K	22	25	48		I	4512	K		25	100
1.6	84 HP			09-83	12-90	3012	K	22	25	48		I					
70				03-88		3504	K	22	20	48		E					
70, 70S, 70ES, 75, 85S				09-83	12-90	3504	K	22	20	48		E					
REGATA DIESEL																	
1.7 D	43/44 kW (58-60 HP)			09-83	12-90	3504	K	22	20	48		E					
1.9 D	48 kW (65 HP)			09-83	12-90	3504	K	22	20	48		E					
1.9 TURBO DIESEL	59 kW (80 HP)			09-83	12-90	3012	K	22	25	48		I	4512	K		25	100
RITMO (A.T.)																	
1,5	55 kW (75 HP)			01-78	06-80	3012	K	22	25	48		I					
1,5	55/61 kW (75-82 HP)			07-80	12-87	3504	K	22	20	48		E					
75				07-80		3504	K	22	20	48		E					
NUOVA, NUOVA SUPER				01-82	12-87	3012	K	22	25	48		I	4511	K		33	94
TT				01-78	06-80	3012	K	22	25	48		I	4511	K		33	94
RITMO (M.T.)																	
1.1	41/44 kW (55-60 HP)			01-78	12-87	3504	K	22	20	48		E					
1.3	48/55 kW (65-75 HP)			01-78	12-87	3504	K	22	20	48		E					
1.5	55 kW (75 HP)			01-78	07-80	3012	K	22	25	48		I	4512	K		25	100
1.5	55/61 kW (75-82 HP)			07-80	12-87	3012	K	22	25	48		I					
1.6	66/77 kW (90-105 HP)			05-81	12-87	3012	K	22	25	48		I	4512	K		25	100
2.0	92/95 kW (125-130 HP)			09-81	12-87	3706	K	25	25	52		I	4512	K		25	100
75 L, CL					07-80	3012	K	22	25	48		I	4512	K		25	100
105 TC				05-81	12-87	3012	K	22	25	48		I	4512	K		25	100
125 TC e 130 TC				09-81	12-83	3706	K	25	25	52		I	4512	K		25	100



CHASSIS ↑

→ CHASSIS

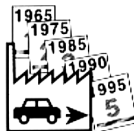
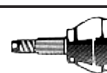
**G L O N .**

XXXX K A B C ABS P XXXX K A B C

FIAT

CL, STRADA			01-78	12-87	3504	K	22	20	48		E							
NUOVA			01-82	12-87	3504	K	22	20	48		E							
NUOVA DIESEL			01-82	12-87	3504	K	22	20	48		E							
NUOVA SUPER			01-82	12-87	3504	K	22	20	48		E							
RITMO CABRIO (BERTONE) M/T																		
85 1.5	60/63 kW (81-85 HP)		01-80	07-89	3012	K	22	25	48		I							
100 1.6	74kW (100 HP)		10-85	12-87	3012	K	22	25	48		I							
RITMO DIESEL																		
1.7 D	43/44 kW (58-60 HP)		07-80	12-87	3504	K	22	20	48		E							
1.9 TURBO DIESEL	59 kW (80 HP)		11-86	12-87	3012	K	22	25	48		I	4512	K			25	100	
SCUDO																		
1.6			03-95		3348	K	27	34	59		I							
1.6 ABS			03-95		3287	K	27	34	59	48	I							
SCUDO DIESEL																		
1.9 DIESEL			03-95		3348	K	27	34	59		I							
1.9 DIESEL ABS			03-95		3287	K	27	34	59	48	I							
1.9 TURBO DIESEL	68 kW (92 HP)		03-95		3349	K	27	39	59		I							
1.9 TURBO DIESEL ABS	68 kW (92 HP)		03-95		3288	K	27	39	59	48	I							
SIENA (AMERICA LATINA)																		
1.5, 1.6			01-96		3363	K	22	22	52		E							
1.6 ABS			01-96		3364	K	22	22	52	44	E							
SPAZIO (BRAZIL)																		
1.05, 1.3			83	84	3501	K	20	20	43,1		E							
TALENTO																		
2.0			09-89		3076	K	28	27	63		I							
TALENTO DIESEL																		
1.9 D			09-89		3076	K	28	27	63		I							
TEMPRA (A.T.)																		
1.4	51/57 kW (69-78 HP)		02-90	07-90	3667	K	22	20	46		E	4512	K			25	100	
1.4	51/57 kW (69-78 HP)		07-90									4512	K			25	100	
1.4 ABS	51/57 kW (69-78 HP)		02-90									4512	K			25	100	
1.6	55/63 kW (75-86 HP)		02-90	07-90	3667	K	22	20	46		E	4512	K			25	100	
1.6	55/63 kW (75-86 HP)		07-90									4512	K			25	100	
1.6 ABS	55/63 kW (75-86 HP)		07-90									4512	K			25	100	
TEMPRA (M.T.)																		
1.4	51/57 kW (69-78 HP)		02-90	07-90	3667	K	22	20	46		E							
1.4 ABS			02-90		3168	K	22	20	46	44	E							
1.6	55/63 kW (75-86 HP)		02-90	07-90	3667	K	22	20	46		E							
1.6 ABS			02-90		3168	K	22	20	46	44	E							
1.8	66/79 kW (90-107 HP)		02-90		3706	K	25	25	52		I	4512	K			25	100	
1.8 ABS	66/79 kW (90-107 HP)		02-90		3671	K	25	25	52	90	I	4512	K			25	100	
1.8 ABS					3673	K	25	25	52	44	I							
2.0	83/85 kW (113-115 HP)		02-90		3706	K	25	25	52		I	4512	K			25	100	
2.0 ABS	83/85 kW (113-115 HP)		02-90		3671	K	25	25	52	90	I	4512	K			25	100	
TEMPRA DIESEL																		
1.9 D	48 kW (65 PS)		02-90	07-90	3667	K	22	20	46		E							

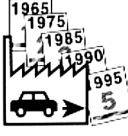

		CHASSIS →	→ CHASSIS		G L O N .																	
					XXXX	K	A	B	C	ABS	P	XXXX	K	A	B	C						
FIAT																						
1.9 D ABS				02-90		3168	K	22	20	46	44	E										
1.9 TURBO DIESEL (SX) 60/68 kW (82-92 HP)				02-90		3706	K	25	25	52		I	4512	K			25	100				
1.9 TURBO DIESEL (DX) ABS 60/68 kW (82-92 HP)				02-90		3671	K	25	25	52	90	I	4512	K			25	100				
1.9 TURBO DIESEL ABS						3673	K	25	25	52	44	I										
TIPO (A.T.)																						
1.1 41 kW (56 HP)				01-88 07-90		3667	K	22	20	46		E	4512	K			25	100				
1.1 41 kW (56 HP)				07-90									4512	K			25	100				
1.1 ABS 41 kW (56 HP)				01-88									4512	K			25	100				
1.1 ABS 41 kW (56 HP)				01-88 10-91		3168	K	22	20	46	44	E	4512	K			25	100				
1.4 51/57 kW (69-78 HP)				01-88 07-90		3667	K	22	20	46		E	4512	K			25	100				
1.4 51/57 kW (69-78 HP)				07-90									4512	K			25	100				
1.4 ABS 51/57 kW (69-78 HP)				01-88									4512	K			25	100				
1.4 ABS, 1.4i.e. ABS 51/52 kW (69-70 HP)				07-87 03-93		3168	K	22	20	46	44	E	4512	K			25	100				
1.6 55/63 kW (75-86 HP)				01-88 07-90		3667	K	22	20	46		E	4512	K			25	100				
1.6 55/63 kW (75-86 HP)				07-90									4512	K			25	100				
1.6 ABS 55/63 kW (75-86 HP)				01-88									4512	K			25	100				
TIPO (M.T.)																						
1.1 41 kW (56 HP)				01-88 07-90		3667	K	22	20	46		E										
1.1 ABS 41 kW (56 HP)				01-88 10-91		3168	K	22	20	46	44	E										
1.4 51/57 kW (69-78 HP)				01-88 07-90		3667	K	22	20	46		E										
1.4 ABS, 1.4i.e. ABS 51/52 kW (69-70 HP)				07-87 03-93		3168	K	22	20	46	44	E										
1.6 55/63 kW (75-86 HP)				01-88 07-90		3667	K	22	20	46		E										
1.8 66/79 kW (90-107 HP)				01-88		3706	K	25	25	52		I	4512	K			25	100				
1.8 ABS 66/79 kW (90-107 HP)				01-88		3671	K	25	25	52	90	I	4512	K			25	100				
2.0 83/85 kW (113-115 HP)				06-90		3706	K	25	25	52		I	4512	K			25	100				
2.0 ABS 83/85 kW (113-115 HP)				06-90		3671	K	25	25	52	90	I	4512	K			25	100				
2.0 ANTISKID ABS						3673	K	25	25	52	44	I										
TIPO DIESEL																						
1.7 D 42/43 kW (57-58 HP)				01-88 07-90		3667	K	22	20	46		E										
1.7 DIESEL ABS				01-88 07-90		3671	K	25	25	52	90	I										
1.9 D 48 kW (65 HP)				01-88 07-90		3667	K	22	20	46		E										
1.9 DIESEL ABS				01-88 07-90		3671	K	25	25	52	90	I										
1.9 TURBO DIESEL 60/68 kW (82-92 HP)				01-88		3706	K	25	25	52		I	4512	K			25	100				
1.9 TURBO DIESEL ABS 60/68 kW (82-92 HP)				01-88		3671	K	25	25	52	90	I	4512	K			25	100				
ULYSSE																						
1.8ie. 73 kW (99 HP)				08-94		3348	K	27	34	59		I										
1.8ie. ABS 73 kW (99 HP)				08-94		3287	K	27	34	59	48	I										
1.9 TURBO DIESEL 68 kW (92 HP)				03-95		3349	K	27	39	59		I										
1.9 TURBO DIESEL ABS 68 kW (92 HP)				03-95		3288	K	27	39	59	48	I										
2.0i. 89 kW (121 HP)				08-94		3348	K	27	34	59		I										
2.0i. ABS 89 kW (121 HP)				08-94		3287	K	27	34	59	48	I										
2.0i. TURBO ABS 108 kW (147 HP)				08-94		3288	K	27	39	59	48	I										
2.1 TURBO DIESEL 12V 80 kW (109 HP)				08-96		3349	K	27	39	59		I										
2.1 TURBO DIESEL 12V ABS 80 kW (109 HP)				08-96		3288	K	27	39	59	48	I										
UNO																						
0.9 33 kW (45 HP)				01-83		3501	K	20	20	43,1		E										



CHASSIS ↑

→ CHASSIS

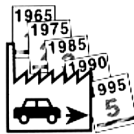

G L O N .

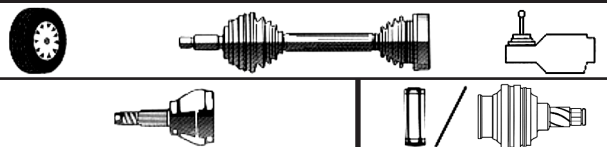

XXXX	K	A	B	C	ABS	P	XXXX	K	A	B	C
------	---	---	---	---	-----	---	------	---	---	---	---

FIAT

1.0	33 kW (45 HP)		01-85		3501	K	20	20	43,1		E						
1.1	38/43 kW (51-58 HP)		01-83		3501	K	20	20	43,1		E						
1.3	48/51 kW (65-70 HP)		01-83		3501	K	20	20	43,1		E						
1.4	51/53 kW (70-72 HP)		01-85		3501	K	20	20	43,1		E						
1.4 TURBO	82/84 kW (111-114 HP)		04-85	08-93	3012	K	22	25	48		I	4512	K		25	100	
1.4 TURBO ABS	82/84 kW (111-114 HP)		11-87	08-93	3247	K	22	25	48	64	I	4512	K		25	100	
1.5	55 kW (75 HP)		01-85		3501	K	20	20	43,1		E	4512	K		25	100	
45, 55, 70, 75			01-83		3501	K	20	20	43,1		E						
UNO DIESEL																	
1.3 D	33 kW (45 HP)		05-83		3501	K	20	20	43,1		E						
1.4 TURBO DIESEL	51 kW (70 HP)		04-86		3504	K	22	20	48		E						
1.7 D	44 kW (60 HP)		09-86		3504	K	22	20	48		E	4512	K		25	100	
X 1/9																	
1.3 4 GEAR	53 kW (73 HP)		11-72	12-78	3501	K	20	20	43,1		E						
1.5 5-GEAR	55/63 kW (75-85 HP)		01-78	12-88	4512	K		25	100			4512	K		25	100	
127																	
0,9	30/35 kW (40-47 HP)		01-71	02-80	3501	K	20	20	43,1		E						
0,9	30/33 kW (40-45 HP)		03-80	12-87	3504	K	22	20	48		E						
1.3 D			01-81	12-87	3504	K	22	20	48		E						
PANORAMA 1.05			03-80	12-87	3504	K	22	20	48		E						
SPORT 1.05	51 kW (70 HP)		06-78	12-87	3501	K	20	20	43,1		E						
SPORT 1.05	51 kW (70 HP)		03-80	12-87	3501	K	20	20	43,1		E						
SPORT 1.3	55 kW (75 HP)		11-81	12-87	3504	K	22	20	48		E						
128																	
1,1	33/41 kW (45-55 HP)		2511997	03-69	12-80	3501	K	20	20	43,1	E						
1,1	33/41 kW (45-55 HP)	2511998		01-81	12-82	3504	K	22	20	48	E						
1,3	44 kW (60 HP)		2511997	03-69	12-80	3501	K	20	20	43,1	E						
1,3	44 kW (60 HP)	2511998		01-81	12-82	3504	K	22	20	48	E						
1.3 3P			03-80		3504	K	22	20	48		E						
COUPE' 1.1	47 kW (64 HP)		01-69	02-80	3501	K	20	20	43,1		E						
COUPE' 1.3	55 kW (75 HP)		01-69	02-80	3501	K	20	20	43,1		E						
PANORAMA 1.1	33/41 kW (45-55 HP)		2511997	01-69	12-80	3501	K	20	20	43,1	E						
PANORAMA 1.1	33/41 kW (45-55 HP)	2511998		01-81	12-82	3504	K	22	20	48	E						
PANORAMA 1.3	44 kW (60 HP)		2511997	01-69	12-80	3501	K	20	20	43,1	E						
PANORAMA 1.3	44 kW (60 HP)	2511998		01-81	12-82	3504	K	22	20	48	E						
RALLY 1.349 kW (67 HP)			01-71	02-80	3501	K	20	20	43,1		E						
147 (BRAZIL)																	
1.05, 1.3			76		3501	K	20	20	43,1		E						



	CHASSIS →	→ CHASSIS		G L O N .										
				XXXX	K	A	B	C	ABS	P	XXXX	K	A	B
FORD (AUSTRALIA)														
CORTINA (LONGITUDINAL SHAFT)														
TC, TURBO DIESEL, TE, TF	4 CYL		01-71	12-82	4060			24	94					
ESCORT (LONGITUDINAL SHAFT)														
MK1	4 CYL		01-62	12-71	4060			24	94					
MK2	4 CYL		01-62	12-71	4060			24	94					
FORD (BRAZIL)														
BELINA														
I, TT			01-71	09-77	3264	K	24	30	46		E			
II, TT			09-77	12-86	3264	K	24	30	46		E			
CORCEL														
I, TT			01-71	09-77	3264	K	24	30	46		E			
II, TT			09-77	12-86	3264	K	24	30	46		E			
DEL REY														
SCALA, A.T.			10-82	05-88	3264	K	24	30	46		E			
SCALA, M.T.			01-81	07-89	3264	K	24	30	46		E			
SCALA, M.T.			08-89	04-91	3265	K	24	30	46		I			
TT, A.T.			10-82	05-88	3264	K	24	30	46		E			
TT, M.T.			01-81	07-89	3264	K	24	30	46		E			
TT, M.T.			08-89	04-91	3265	K	24	30	46		I			
ESCORT														
1.0 L HOBBY AE			08-93		3266	K	23	30	55		I			
1.6 L			01-83	11-92	3675	K	23	22	55		E			
1.6 L HOBBY AE			08-93		3266	K	23	30	55		I			
1.8 L			05-89	12-92	3266	K	23	30	55		I			
1.8 L GUARUJA			01-91	11-92	3266	K	23	30	55		I			
GALAXY														
2.0			01-94		3547	K	22	30	51		I			
ORION														
1,6					3332	K	25	30	56,5		I			
1,8					3333	K	25	30	56,5		I			
PAMPA														
4 x 2			05-81	07-89	3264	K	24	30	46		E			
4 x 2			08-89		3265	K	24	30	46		I			
4 x 4			06-83		3264	K	24	30	46		E			
ROYALE														
(M.T.)			02-92	11-92	3548	K	22	30	51		I			



CHASSIS →

→ CHASSIS



G L O N .

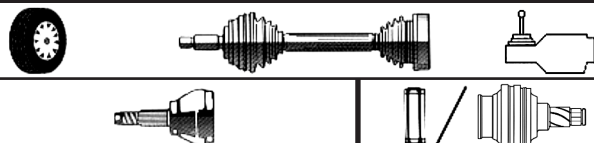

XXXX K A B C ABS P XXXX K A B C

FORD (BRAZIL)

VERSAILLES																		
(M.T.)			06-91	11-92	3548	K	22	30	51		I							
VERONA																		
1.6 L			01-90	12-92	3675	K	23	22	55		E							
1.8 L			01-90	03-93	3266	K	23	30	55		I							

FORD (EUROPE)

CONSUL																		
1.7	48/55 kW (65-75 HP)		01-72	12-75	4512	K		25	100			4512	K		25	100		
2.0	73 kW (99 HP)		01-72	12-75	4512	K		25	100			4512	K		25	100		
2.3	80 kW (109 HP)		01-72	12-75	4512	K		25	100			4512	K		25	100		
ESCORT CABRIO (M.T.)																		
1,4	55 kW (75 HP)		02-95		3257	K	25	22	56.5		E							
1.6 16V XR3i	65/66 kW (88-90 HP)		02-95		3257	K	25	22	56.5		E							
1.8 16V XR3i	85 kW (115 HP)		10-95		3257	K	25	22	56.5		E							
1.8 TURBO DIESEL	66 kW (90 HP)		12-95		3355	K	25	25	56,6		E							
ESCORT-ESCORT VAN-ORION (A.T.)																		
1,4 (gear CTX)	54/55 kW (73-75 HP)		04-86	08-90	3675	K	23	22	55		E							
1,6 (gear ATX)	58/66 kW (79-90 HP)		11-82	07-89	3675	K	23	22	55		E							
1,6 (gear CTX)	58/66 kW (79-90 HP)		04-86	08-90	3675	K	23	22	55		E							
VAN 1.1	41 kW (55 HP)		04-86	08-90	3675	K	23	22	55		E							
ESCORT-ESCORT VAN-ORION (M.T.)																		
1.1	37/43 kW (50-59 HP)		08-80	01-82	3084	K	23	20	50		E	4049	K	23	20	75		
1.1	37/43 kW (50-59 HP)		02-82	09-88	3084	K	23	20	50		E	4049	K	23	20	75		
1.1	37/43 kW (50-59 HP)		09-88	08-90	3675	K	23	22	55		E							
1.3	44/50 kW (60-68 HP)		09-90	10-91	3256	K	23	22	48		E							
1.3	44 kW (60 HP)		02-95		3174	K	23	20	60		E							
1.3 - 1.3 ABS	44/50 kW (60-68 HP)		08-80	12-85	3675	K	23	22	55		E	4050	K	23	22	82		
1.3 - 1.3 ABS	44/50 kW (60-68 HP)		01-86	08-90	3084	K	23	20	50		E	4049	K	23	20	75		
1.4	52/55 kW (71-75 HP)		09-90	10-91	3256	K	23	22	48		E							
1.4	55 kW (75 HP)		02-95		3257	K	25	22	56.5		E							
1.4 - 1.4 ABS	52/55 kW (71-75 HP)		01-86	08-90	3675	K	23	22	55		E	4050	K	23	22	82		
1.4 ABS	52/55 kW (71-75 HP)		09-90		3257	K	25	22	56.5		E							
1.6	58/77 kW (79-105 HP)		02-80	08-90	3675	K	23	22	55		E	4050	K	23	22	82		
1.6 16V	66 kW (89 HP)		02-95		3257	K	25	22	56.5		E							
1.6 ABS	58/77 kW (79-105 HP)		01-86	09-90	3675	K	23	22	55		E							
1.6 ABS	58/77 kW (79-105 HP)		09-90		3257	K	25	22	56.5		E							



		CHASSIS →	→ CHASSIS		G L O N .												
					XXXX	K	A	B	C	ABS	P	XXXX	K	A	B	C	
FORD (EUROPE)																	
1.8 (gear MTX)	77/96 kW (105-131 HP)			01-92		3257	K	25	22	56.5		E					
1.8 16V	85 kW (115 HP)			02-95		3257	K	25	22	56.5		E					
1.8 ABS (gear MTX75)	77/96 kW (105-131 HP)			09-91		3355	K	25	25	56,6		E					
2.0 ABS (gear MTX75)	110 kW (150 HP)			10-91		3355	K	25	25	56,6		E					
VAN 1.1	37/43 kW (50-59 HP)			08-80	08-90	3675	K	23	22	55		E					
VAN 1.3	44/50 kW (60-68 HP)			08-80	08-90	3675	K	23	22	55		E					
VAN 1.3	44/50 kW (60-68 HP)			09-90	10-91	3256	K	23	22	48		E					
VAN 1.3 ABS	44/50 kW (60-68 HP)			10-91		3257	K	25	22	56.5		E					
ESCORT-ORION DIESEL (M.T.)																	
1.6 D	40 kW (54 HP)			02-84	08-90	3675	K	23	22	55		E					
1.8 D	44 kW (60 HP)			04-86	08-90	3675	K	23	22	55		E					
1.8 D	44 kW (60 HP)			09-90		3257	K	25	22	56.5		E					
1.8 TURBO DIESEL (gear MTX75)	65/66 kW (88-90 HP)			04-91		3355	K	25	25	56,6		E					
ESCORT 4x4 - ORION 4x4																	
1.8 (gear MTX75)	77/96 kW (105-131 HP)			01-92		3257	K	25	22	56.5		E					
2.0 ABS (gear MTX75)	110 kW (150 HP)			10-91		3257	K	25	22	56.5		E					
FIESTA - FIESTA VAN (M.T.)																	
1.0	30/33 kW (40-45 HP)			05-76	08-79	3087	K	22	20	50		E					
1.0	30/33 kW (40-45 HP)			09-79	07-80	3087	K	22	20	50		E	4049	K	23	20	75
1.0	30/33 kW (40-45 HP)			08-80	03-89	3084	K	23	20	50		E	4049	K	23	20	75
1.0	33 kW (45 HP)			04-89	05-94	3174	K	23	20	60		E	4049	K	23	20	75
1.1	36/40 kW (49-54 HP)			09-79	07-80	3087	K	22	20	50		E	4049	K	23	20	75
1.1	36/40 kW (49-54 HP)			08-80	03-89	3084	K	23	20	50		E	4049	K	23	20	75
1.1	36/40 kW (49-54 HP)			04-89	05-94	3174	K	23	20	60		E	4049	K	23	20	75
1.1 ABS	36/40 kW (49-54 HP)			09-90	05-94	3174	K	23	20	60		E					
1.2 16V				01-96		3354	K	25	22	56,6		E					
1.3	44/51 kW (60-70 HP)			08-80	01-87	3675	K	23	22	55		E					
1.3	44/51 kW (60-70 HP)			07-90	01-94	3256	K	23	22	48		E					
1.3	44/51 kW (60-70 HP)			01-94		3354	K	25	22	56,6		E					
1.3 JAS/JBS	37/44 kW (50-60 HP)			01-96		3401	K	25	20	56,5		E					
1.3 ABS	44/51 kW (60-70 HP)			07-90	01-94	3256	K	23	22	48		E					
1.3 ABS	44/51 kW (60-70 HP)			01-94		3354	K	25	22	56,6		E					
1.4	44/55 kW (60-75 HP)			01-86	03-89	3675	K	23	22	55		E					
1.4	44/55 kW (60-75 HP)			04-90	01-94	3256	K	23	22	48		E					
1.4	44/55 kW (60-75 HP)			01-94		3354	K	25	22	56,6		E					
1.4 16V				01-96		3354	K	25	22	56,6		E					
1.4 ABS	44/55 kW (60-75 HP)			04-90	01-94	3256	K	23	22	48		E					
1.4 ABS	44/55 kW (60-75 HP)			01-94		3354	K	25	22	56,6		E					
1.6 XR2	58/81 kW (79-110 HP)			09-81	03-89	3675	K	23	22	55		E					
1.6 12V	66 kW (90 HP)			04-89	01-94	3256	K	23	22	48		E					
1.6 12V ABS	66 kW (90 HP)			04-89	01-94	3256	K	23	22	48		E					
1.6 12V ABS	66 kW (90 HP)			01-94		3257	K	25	22	56.5		E					
1.6 XR2	58/81 kW (79-110 HP)			04-89	01-94	3256	K	23	22	48		E					
1.6 XR2	58/81 kW (79-110 HP)			01-94		3257	K	25	22	56.5		E					
1.6 XR2 ABS	58/81 kW (79-110 HP)			04-89	01-94	3256	K	23	22	48		E					
1.6 XR2 ABS	58/81 kW (79-110 HP)			01-94		3257	K	25	22	56.5		E					



CHASSIS ↑

→ CHASSIS

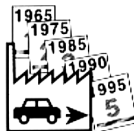

G L O N .

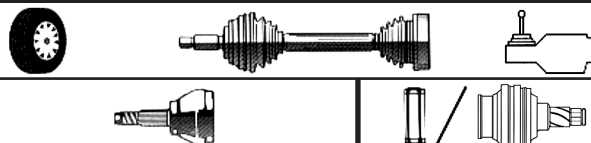





XXXX	K	A	B	C	ABS	P	XXXX	K	A	B	C
------	---	---	---	---	-----	---	------	---	---	---	---

FORD (EUROPE)

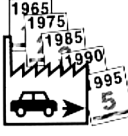
1.8 16V	77/96 kW (105-130 HP)		01-92	01-94	3256	K	23	22	48		E						
1.8 16V	77/96 kW (105-130 HP)		01-94		3257	K	25	22	56.5		E						
1.8 16V ABS	77/96 kW (105-130 HP)		01-92	01-94	3256	K	23	22	48		E						
1.8 16V ABS	77/96 kW (105-130 HP)		01-94		3257	K	25	22	56.5		E						
FIESTA - FIESTA VAN DIESEL (M.T.)																	
1.6 D	40 kW (54 HP)		02-84	04-88	3675	K	23	22	55		E						
1.6 D	40 kW (54 HP)		04-88	03-89	3084	K	23	20	50		E	4049	K	23	20	75	
1.8 D	44 kW (60 HP)		04-89	01-94	3256	K	23	22	48		E						
1.8 D	44 kW (60 HP)		01-94		3354	K	25	22	56,6		E						
1.8 D ABS	44 kW (60 HP)		04-89	01-94	3256	K	23	22	48		E						
1.8 D ABS	44 kW (60 HP)		01-94		3354	K	25	22	56,6		E						
GRANADA																	
1.6	55 kW (75 HP)		08-77	12-85	4512	K		25	100			4512	K		25	100	
1.7	51/55 kW (70-75 HP)		01-72	12-82	4512	K		25	100			4512	K		25	100	
2.0	66/73 kW (90-99 HP)		01-72	12-85	4512	K		25	100			4512	K		25	100	
2.3	80 kW (109 HP)		01-72	12-85	4512	K		25	100			4512	K		25	100	
2.8	110/118 kW (150-160 HP)		08-77	12-85	4512	K		25	100			4512	K		25	100	
GRANADA DIESEL																	
2.1 D			08-77	12-85	4512	K		25	100			4512	K		25	100	
2.5 DIESEL M.T.			08-82	08-85	4512	K		25	100			4512	K		25	100	
KA																	
1,3			11-96		3401	K	25	20	56,5		E						
MONDEO (M.T.)																	
1.6i 16V	66 kW (90 HP)		01-93		3357	K	27	30	57	44	I						
1.6i 16V ABS	66 kW (90 HP)		01-93		3357	K	27	30	57	44	I						
1.8i 16V	85 kW (115 HP)		01-93		3357	K	27	30	57	44	I						
1.8i 16V ABS	85 kW (115 HP)		01-93		3357	K	27	30	57	44	I						
2.0i 16V	100 kW (136 HP)		01-93		3357	K	27	30	57	44	I						
2.0i 16V ABS	100 kW (136 HP)		01-93		3357	K	27	30	57	44	I						
2.5i 24V	125 kW (170 HP)		08-94		3358	K	27	25	57		I						
2.5i 24V ABS	125 kW (170 HP)		08-94		3356	K	27	25	57	44	I						
MONDEO (A.T.)																	
1.8i 16V	85 kW (115 HP)		06-93	12-94	3358	K	27	25	57		I						
1.8i 16V ABS	85 kW (115 HP)		06-93	12-94	3356	K	27	25	57	44	I						
1.8i 16V ABS	85 kW (115 HP)		01-95		3357	K	27	30	57	44	I						
2.0i 16V	100 kW (136 HP)		01-93	12-94	3358	K	27	25	57		I						
2.0i 16V ABS	100 kW (136 HP)		01-93	12-94	3356	K	27	25	57	44	I						
2.0i 16V ABS	100 kW (136 HP)		01-95		3357	K	27	30	57	44	I						
MONDEO DIESEL (M.T.)																	
1.8i TURBO DIESEL	65 kW (88 HP)		09-93		3358	K	27	25	57		I						
1.8i TURBO DIESEL ABS	65 kW (88 HP)		09-93		3356	K	27	25	57	44	I						
PROBE (A.T.-M.T.)																	
2.2 NO TURBO			01-88	12-92	3176	K	26	25	56		M						
PUMA																	
1.4 16V M.T.	66 kW (90 HP)		11-97		3354	K	25	22	56,6		E						



	CHASSIS →	→ CHASSIS		G L O N .											
															
				XXXX	K	A	B	C	ABS	P	XXXX	K	A	B	C
FORD (EUROPE)															
SCORPIO															
1.8	66 kW (90 HP)		05-85	12-94	4512	K	25	100				4512	K	25	100
2.0	75/92 kW (101-125 HP)		05-85	12-94	4512	K	25	100				4512	K	25	100
2.4 V6	92/95 kW (125-130 HP)		01-87	12-94	4512	K	25	100				4512	K	25	100
2.8 V6	107/110 kW (145-150 HP)		05-85	12-87	4512	K	25	100				4512	K	25	100
2.9 V6	107/143 kW (145-195 HP)		01-87	12-94	4512	K	25	100				4512	K	25	100
SCORPIO DIESEL															
2.5 D	51 kW (69 HP)		01-86	12-94	4512	K	25	100				4512	K	25	100
2.5 TURBO DIESEL	68/85 kW (92-115 HP)		01-86	12-94	4512	K	25	100				4512	K	25	100
SIERRA 4WD															
TT RWD					4512	K	25	100				4512	K	25	100
FORD (TAIWAN)															
FESTIVA															
1.3					3506	K	24	21	52		I				
1.5					3502	K	24	22	52	44	I				
FORD (USA)															
ESCORT															
1.8L ABS			91	96	3440	K	26	28	56	44	I				
1.9L ABS			91	96	3440	K	26	28	56	44	I				
ESCORT & EXP															
1,9			01-86	12-90	3023	K	26	23	51,1		I				
2.0 DIESEL, M.T.			01-86	12-87	3023	K	26	23	51,1		I				
TT			01-81	12-82	3022		23	23	55		I				
TT NO TURBO			01-84	12-85	3023	K	26	23	51,1		I				
TT TURBO			12-84	12-85	3078	K	26	32	51,1		I				
TT TURBO			01-85	12-85	3023	K	26	23	51,1		I				
TT, A.T.			01-83	12-83	3022		23	23	55		I				
TT, M.T.			01-83	03-83	3022		23	23	55		I				
TT, M.T.			04-83	12-83	3023	K	26	23	51,1		I				



CHASSIS ↑

→ CHASSIS



G L O N .

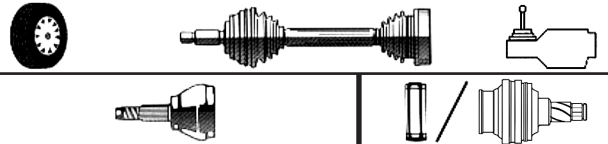





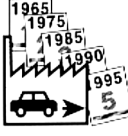

XXXX	K	A	B	C	ABS	P	XXXX	K	A	B	C
------	---	---	---	---	-----	---	------	---	---	---	---

FORD (USA)

FESTIVA																			
1.1 - 1.3	DA1-DA3		01-85	12-89	3371	K	24	19	52		M								
1.3 (A.T.)	DA1 B3 1300		01-86		3371	K	24	19	52		M								
1.3 (M.T.)	DAJ-DOHC		01-86		3372	K	24	20	52		M								
1.3 (M.T.)	DA3		01-89		3372	K	24	20	52		M								
PROBE (A.T.-M.T.)																			
2.2 NO TURBO			01-88	12-92	3176	K	26	25	56		M								
V6 TURBO			01-88	12-92	3322	K	28	26	56		I								
TAURUS																			
3.0 V-6 (NO SHO)	ACI DESIGN		01-86	12-90	3062	K	26	30	55,82		I								
3.0 V-6 (NO SHO)	T & C DESIGN		01-86	12-90	3062	K	26	30	55,82		I								
3.0 V-6 (NO SHO)			01-91	12-92	3062	K	26	30	55,82		I								
3.0 V6 ABS			90		3161	K	26	32	55,8	50	I								
3.0 V6 S.W.			90		3062	K	26	30	55,82		I								
3.8 V-6			01-88	12-92	3102	K	26	32	55,8		I								
3.8 V-6, ABS			01-90	12-92	3161	K	26	32	55,8	50	I								
4 CYL			01-90	12-90	3062	K	26	30	55,82		I								
4 CYL, A.T.			01-86	12-89	3062	K	26	30	55,82		I								
4 CYL, M.T.			01-86	12-88	3062	K	26	30	55,82		I								
SHO			01-89	12-89	3102	K	26	32	55,8		I								
SHO ABS			01-90	12-92	3161	K	26	32	55,8	50	I								
TELSTAR																			
1,6	Eng. B6/F8		09-87	12-92	3176	K	26	25	56		M								
1,8	Eng. B6/F8		09-87	12-92	3176	K	26	25	56		M								
2.0	Eng. FE/RF Except TURBO		09-87	12-92	3176	K	26	25	56		M								
2.2	Eng. FE/RF Except TURBO		09-87	12-92	3176	K	26	25	56		M								
NEW	4 CYL (ABS READY OR NON-ABS)		01-94		3321	K	28	23	56		I								
PROBE TURBE	6 CYL (ABS READY OR NON-ABS)		01-94		3322	K	28	26	56		I								
TX5 TURBO 2.2			09-87	12-92	3322	K	28	26	56		I								
TEMPO																			
DIESEL			01-85	12-86	3023	K	26	23	51,1		I								
DIESEL 5 SPEED, M.T.			01-84	12-84	3023	K	26	23	51,1		I								
HIGH OUTPUT 2.3			01-85	12-85	3078	K	26	32	51,1		I								
TT 4 SPEED, M.T.			01-84	12-84	3023	K	26	23	51,1		I								
TT 5 SPEED, M.T. (NO DIESEL)			01-84	12-84	3023	K	26	23	51,1		I								
TT, A.T.			01-84	12-91	3023	K	26	23	51,1		I								
TT, M.T. (NO DIESEL & HO 2.3)			01-85	12-85	3078	K	26	32	51,1		I								
TT, M.T. (NO DIESEL)			01-85	12-91	3023	K	26	23	51,1		I								
TRACER																			
TT			01-87		3035	K	24	22	52		M								



	CHASSIS →	→ CHASSIS		GLO N.										
														
														
XXXX	K	A	B	C	ABS	P	XXXX	K	A	B	C			
GEO														
METRO														
75 AC			01-88	12-89	3532	K	23	19	44		M			
PRIZM														
TT NO GSi			01-89	12-92	3596	K	26	29	56		E			
GMB (BRAZIL)														
IPANEMA														
1.8L (A.T.)			09-93		3538	K	33	25	52		E			
1.8L (M.T.)			09-93		3538	K	33	25	52		E			
2.0L (M.T.)			09-93		3538	K	33	25	52		E			
KADETT														
1.8L (A.T.)			09-93		3538	K	33	25	52		E			
1.8L (M.T.)			09-93		3538	K	33	25	52		E			
2.0L (M.T.)			09-93		3538	K	33	25	52		E			
MONZA														
1.8L (A.T.)			09-93		3538	K	33	25	52		E			
2.0L (A.T.)			09-93		3538	K	33	25	52		E			
2.0L (M.T.)			09-93		3538	K	33	25	52		E			
VECTRA														
1,8			09-93		3538	K	33	25	52		E			
2.0L			09-93		3538	K	33	25	52		E			
GMC														
CENTURY,CUTLASS, EUROSPO														
			94	95	3450	K	33	32	50		I			
PICK UP 1/2 TON 4WD & SUBURBAN														
TT			01-88	12-92	3222		33	35	77		E			
PICK UP 3/4 TON 4WD & SUBURBAN														
TT			01-88	12-88	3222		33	35	77		E			
TT (7200 GVWR)			01-89	12-92	3222		33	35	77		E			
TT (8600 GVWR)			01-89	12-92	3221		33	29	80		E			
PICK UP 1 TON 4WD & CHASSIS CAB														
TT			01-92	12-92	3221		33	29	80		E			
TT 2 DOORS			01-88	12-91	3221		33	29	80		E			
S15 JIMMY 4WD, SONOMA & PICK UP														
TT			01-83	12-84	3029		27	34	55,9		E			
TT			01-85	12-90	3018		27	34	55,9		E			
SAFARI VAN 4WD														
TT			01-90	12-91	3222		33	35	77		E			



		CHASSIS ↑	→ CHASSIS		G L O N .											
					XXXX	K	A	B	C	ABS	P	XXXX	K	A	B	C
GRECAV																
AMICA					3115	K	18	18	42		E	4015	K	18	18	62
EKE 505					3115	K	18	18	42		E	4015	K	18	18	62
HOLDEN (AUSTRALIA)																
ASTRA																
1,5	Mod.LB Eng.E15		01-84	06-87	3686	K	24	22	52		I					
1,6	Mod.LC Eng.E16S		01-84	06-87	3686	K	24	22	52		I					
BARINA																
1,3	Mod.MB Eng.13A		02-85	12-88	3532	K	23	19	44		M					
1,3	Mod.MH-ML Eng.13B		01-86	12-94	3532	K	23	19	44		M					
CAMIRA																
1,6	Mod.JB Eng.Opel		01-82	12-84	3538	K	33	25	52		E					
2.0	JD/JE		01-82	12-84	3017	K	33	29	47,7		E					
COMMODORE (LONGITUDINAL SHAFT)																
VB	308		01-78	12-80	4061			25	100							
VB, VC, VH, VK	(CARBY MODEL ONLY) 6 CYL AII.		01-78	12-86	4060			24	94							
VB, VC, VH, VK	8 CYL AII.		01-78	12-86	4061			25	100							
VB, VC, VH, VK	6 CYL HD & V8		01-78	02-86	4061			25	100							
VK (EFI Model Only)	6 CYL AII.		01-78	12-86	4060			24	94							
VL	6 CYL AII.		01-86	12-88	4060			24	94							
VL	8 CYL AII.		01-86	12-88	4061			25	100							
VL 3.0, 5.0			03-86	09-88	4061			25	100							
VN, VP, VQ	6/8 CYL AII		01-88	12-93	4061			25	100							
VR, VS	6/8 CYL AII		01-93		4061			25	100							
NOVA																
1,4	Mod.LE-LF Eng.4A		01-89	09-92	3049	K	26	23	56		I					
1,6	Mod.LE-LF Eng.6A		01-89	09-92	3049	K	26	23	56		I					
1,8	Mod.LE-LF Eng.7A		01-89	09-92	3049	K	26	23	56		I					



	CHASSIS →	→ CHASSIS		G L O N .										
				XXXX	K	A	B	C	ABS	P	XXXX	K	A	B

HONDA

ACCORD																					
1.6 SJ, SM	59 kW (80 HP), EF		01-76	12-79	3015	K	23	22	45		I										
1.6 SM 120	59 kW (80 HP), EP		01-79	12-80	3556	K	23	22	45		M										
1.6 SM 200, SV 100	59 kW (80 HP), EP		01-82	12-83	3082	K	24	30	45		M										
1.8 Mod.CA2/CA5/CA6 Eng. B18A A/T+M/T			01-85	12-89	3581	K	26	32	49		M										
1.8 Mod.CB1/2/3/4-SM4 Eng. F18A A/T+M/T			09-89	08-93	3180	K	28	32	60		M										
1.8 (ABS READY OR NON-ABS) 74 kW (101 HP)			08-89	93	3499	K	28	34	60		M										
1.8 (100 HP)			09-89	01-93	3163	K	28	34	60		M										
1.8 ABS			01-86	12-89	3214	K	26	32	49	100	M										
1.8 ABS			01-93		3400	K	28	32	60	50	M										
1.8 CD3 F18B 1800			09-93		3180	K	28	32	60		M										
1.8 SJ, SM	66kW (90 HP), EK		01-76	12-79	3015	K	23	22	45		I										
1.8 SM	66kW (90 HP), EK		01-79	12-80	3556	K	23	22	45		M										
1.8 SM 200, SC 100 (DX)	72 kW (97 HP), EK		01-82	12-83	3082	K	24	30	45		M										
1.9 ABS Mod. CE7 Eng. F19A3 85 kW (115 HP)			02-96	98	3475	K	28	32	60	50	I										
2.0 Mod.CA3 Eng. B20A A/T+M/T			01-85	12-89	3581	K	26	32	49		M										
2.0 Mod.CB1/2/3/4-SM4 Eng. F20A A/T+M/T			09-89	08-93	3180	K	28	32	60		M										
2.0 (133-135 HP)			09-89	01-93	3163	K	28	34	60		M										
2.0 (ABS READY OR NON-ABS) 99/100 kW (134-136 HP)			08-89	93	3499	K	28	34	60		M										
2.0 ABS			01-86	12-89	3214	K	26	32	49	100	M										
2.0 ABS			01-93		3400	K	28	32	60	50	M										
2.0 ABS Mod. CE8 Eng. F20Z1 96 kW (130 HP)			02-96	98	3475	K	28	32	60	50	I										
2.0 CD4 F20B 2000			09-93		3180	K	28	32	60		M										
2.0 TURBO DIESEL ABS Mod. CF1 Eng. F20T2N 77 kW (104 HP)			02-96	98	3475	K	28	32	60	50	I										
2.2 Mod.CB/3/4-SM4 Eng. F22A A/T+M/T			09-89	01-93	3180	K	28	32	60		M										
2.2 ABS			01-93		3400	K	28	32	60	50	M										
2.2 ABS Mod. CE9 Eng. F22Z2 110 kW (149 HP)			02-96	98	3475	K	28	32	60	50	I										
2.2 CD5 F22B 2200			09-93		3180	K	28	32	60		M										
2.2 CD6 H22A 2200			09-93		3180	K	28	32	60		M										
2.2 CD7 F22B 2200			03-94		3180	K	28	32	60		M										
2.2 CD8 H22A 2200			03-94		3180	K	28	32	60		M										
AC, AD100-RU EY 1600			01-83	12-85	3083	K	24	30	47		M										
AD ES 1800			01-83	12-85	3581	K	26	32	49		M										
S, LX			01-84	12-85	3083	K	24	30	47		M										
SEI			01-86	12-89	3581	K	26	32	49		M										
SEI (USA)			01-84	12-85	3581	K	26	32	49		M										
SJ, SM EF 1600, EK 1800			01-76	12-79	3556	K	23	22	45		M										
SM EK 1800			01-79	12-81	3556	K	23	22	45		M										
SM120 EP 1600, EK 1800			01-79	12-80	3556	K	23	22	45		M										
SM200, SV100 EP 1600, EK 1800			01-80	12-81	3082	K	24	30	45		M										
SY, SZ EP 1600, EK 1800			01-81	12-82	3082	K	24	30	45		M										
TT			01-76	12-77	3015	K	23	22	45		I										
TT			01-76	12-81	3556	K	23	22	45		M										
TT			01-81	12-82	3581	K	26	32	49		M										
TT			01-84	12-84	3083	K	24	30	47		M										
TT (NO SEI)			01-85	12-85	3083	K	24	30	47		M										



CHASSIS ↑

→ CHASSIS



G L O N .

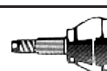



XXXX	K	A	B	C	ABS	P	XXXX	K	A	B	C
------	---	---	---	---	-----	---	------	---	---	---	---

HONDA

TT 3 & 4 DOOR			01-82	12-83	3083	K	24	30	47		M								
CITY																			
1.2 16V (75-76 HP)			11-86		3179	K	23	27	45		M								
1.2 Mod. GA1	Eng.D12A		01-86		3080	K	23	27	49		M								
1.3 Mod. GA2	Eng.D13C		01-86		3052	K	23	30	49		M								
CIVIC																			
1.2			01-73	12-77	3015	K	23	22	45		I								
1.2			01-78	12-79	3556	K	23	22	45		M								
1.2 M.T.	40/48 kW (54-66 HP)		01-73	12-79	3015	K	23	22	45		I								
1.2 M.T.	41/44 kW (55-60 HP)		01-79	12-80	3556	K	23	22	45		M								
1.3 16V A.T./M.T.	Mod. EG3 Eng. D13B2 55kW (75 HP)		10-91	10-95	3498	K	26	30	55		M								
1.3 HATCHBACK			01-84	12-87	3080	K	23	27	49		M								
1.3 M.T.	44 kW (60 HP)		01-73	12-79	3015	K	23	22	45		I								
1.3 M.T.	44 kW (60 HP)		01-79	12-80	3556	K	23	22	45		M								
1.3 M.T. 4-GEAR (SX)	51/55 kW (69-75 HP)		01-84	12-90	3556	K	23	22	45		M								
1.3, 4 SPEED, M.T.			01-80	12-84	3556	K	23	22	45		M								
1.3, 4 SPEED, M.T.			01-84	12-86	3080	K	23	27	49		M								
1.4 ABS	Mod. EJ9 Eng. D14A3 55 kW (75 HP)		95		3486	K	26	28	55	50	M								
1.4 ABS	Mod. EJ9 Eng. D14A4 66 kW (90 HP)		95		3486	K	26	28	55	50	M								
1.5			01-73	12-77	3015	K	23	22	45		I								
1.5			01-78	12-83	3556	K	23	22	45		M								
1.5 ABS			01-93		3389	K	26	23	49		I								
1.5 ABS	Mod. EK3 Eng. D15Z6 84 kW (114 HP)		95		3486	K	26	28	55	50	M								
1.5 CX, DX, EX, LX, VX SOHC (USA)			92	94	3498	K	26	30	55		M								
1.5 DX, GL, Si			01-86	12-87	3052	K	23	30	49		M								
1.5 S, DX			01-84	12-85	3052	K	23	30	49		M								
1.5 WAGON FWD			01-84	12-87	3052	K	23	30	49		M								
1.5i 16V, VTec A.T./M.T.	Mod. EG4, 8 Eng. D15Z1 69 kW (94 HP)		10-91	10-95	3498	K	26	30	55		M								
1.6 16V VTec A.T./M.T.	Mod. EG5, EH9 Eng. D16Z6 92 kW (125 HP)		10-91	10-95	3498	K	26	30	55		M								
1.6 ABS	Mod. EK1 Eng. D16Y8 84 kW (114 HP)		95		3486	K	26	28	55	50	M								
CVCC			01-84	12-85	3274	K	23	30	45		M								
EG7	D 13B (internal groove)		01-91		3415	K	26	30	55		M								
EG8	D 15B (internal groove)		01-91		3415	K	26	30	55		M								
EG9	B 16A		01-91		3220	K	26	32	55		M								
LS1 K600	(no internal groove)		01-91	12-95	3374	K	26	30	55		I								
SB1, SG, SH	EB 1300		01-77	12-79	3556	K	23	22	45		M								
SH110, SK110	ED 1500		01-77	12-79	3556	K	23	22	45		M								
SHUTTLE 1.5	63 kW		01-84	12-87	3052	K	23	30	49		M								
SHUTTLE 1.6 i.e. 16V	EE4		01-87		3211	K	26	23	49		M								
SHUTTLE EF4, EF5 (DX)	D15B 1500		01-87	12-92	3211	K	26	23	49		M								
SHUTTLE EF4, EF5 (SX)	D15B 1500		01-87	12-92	3581	K	26	32	49		M								
SL, SS	EJ 1300		01-80	12-83	3556	K	23	22	45		M								
SL, SS	FJ 1300		01-80	12-84	3274	K	23	30	45		M								
SL100, SS100			01-77	12-79	3556	K	23	22	45		M								
SP100, SG120	EJ5 1300		01-77	12-79	3556	K	23	22	45		M								
SR, ST	FN 1500		01-81	12-83	3274	K	23	30	45		M								



		CHASSIS →	→ CHASSIS		G L O N .										
					XXXX	K	A	B	C	ABS	P	XXXX	K	A	B
HONDA															
SR100, ST100	EM 1500			01-80	12-83	3556	K	23	22	45		M			
TT				01-73	12-77	3015	K	23	22	45		I			
TT				01-78	12-83	3556	K	23	22	45		M			
TT (NO 1.3 HATCHBACK & WAGON 4WD)				01-84	12-87	3052	K	23	30	49		M			
CIVIC, BALLADE, CRX															
1.3				01-81	12-83	3274	K	23	30	45		M			
1.3 HF M.T. (SX)				01-88	12-90	3556	K	23	22	45		M			
1.3, 5 SPEED, M.T. (NO '86)				01-84	12-87	3080	K	23	27	49		M			
1.5				01-81	12-83	3274	K	23	30	45		M			
1.5 (NO HF)				01-84	12-87	3052	K	23	30	49		M			
1.5 HF, M.T. (NO '86)				01-84	12-87	3080	K	23	27	49		M			
AG, AJ, VJ	EV 1300			01-84	12-87	3080	K	23	27	49		M			
AH, AK	EW 1500			01-84	12-87	3052	K	23	30	49		M			
AT, AU, AS	ZC 1600			01-84	12-86	3581	K	26	32	49		M			
EF1	D13B 1300			01-87	12-92	3080	K	23	27	49		M			
EF2, EF6	D15B 1500			01-87	12-92	3106	K	26	30	49		M			
EF3, EF7	ZC 1600			01-87	12-92	3581	K	26	32	49		M			
EF4, EF5 4WD (DX)	D15B 1500			01-87	12-92	3211	K	26	23	49		M			
EF4, EF5 4WD (SX)	D15B 1500			01-87	12-92	3581	K	26	32	49		M			
EG9	E 16A 1600	(internal groove)		01-92		3415	K	26	30	55		M			
LS1 K600		(no internal groove)		01-91	12-95	3374	K	26	30	55		I			
CONCERTO															
1,6				01-87	12-92	3211	K	26	23	49		M			
1.6 16V Mod. HW ABS	Eng. D 16A8, D16Z2 82/90 kW (111-122 HP)			89	95	3466	K	26	23	49	50	I			
1.6 Mod JH	Eng. D16A (AUSTRALIA)			01-88	12-91	3581	K	26	32	49		M			
INTEGRA (ACURA)															
1.6 3 & 5 DOOR				01-86	12-89	3581	K	26	32	49		M			
1.6 ABS	Mod. DA6 Eng. B16A			89	93	3434	K	26	32	55	50	M			
1.6 Mod DA6	Eng. B16A			01-89	12-93	3105	K	26	32	49		M			
DA1, AV, DA2	ZC 1600, EW 1500			01-85		3581	K	26	32	49		M			
TT				01-86	12-89	3581	K	26	32	49		M			
JAZZ															
1.2 Mod GA1	Eng. D12A			01-87		3052	K	23	30	49		M			
1.3 Mod GA2	Eng. D13C			01-87		3052	K	23	30	49		M			
LEGEND (ACURA)															
2.0 Mod.	Mod. KA1-KA2-KA4 Eng. C20A			01-85	12-88	3163	K	28	34	60		M			
2.5i V6 24V	Mod. HS Eng. C25A			01-86	12-90	3163	K	28	34	60		M			
2.7i V6 24V	Mod. KA-HS Eng. C27A			02-87	04-91	3163	K	28	34	60		M			
3.2i V6 24V	Eng. 32A			05-91		3163	K	28	34	60		M			
KA-7 ABS	C32A			01-90		3263	K	28	34	60	50	M			
KA-8 ABS	C32A			01-90		3263	K	28	34	60	50	M			
TT V6 ABS				01-86	12-90	3263	K	28	34	60	50	M			
LEGEND (ACURA) A.T./M.T.															
2.0 (ABS READY OR NON-ABS)	Mod. KA1, KA2, KA4 Eng. C20A			85	88	3499	K	28	34	60		M			
2.5i V6 24V (ABS READY OR NON-ABS)	Mod. HS Eng. C25A			01-86	12-90	3499	K	28	34	60		M			
2.7i V6 24V (ABS READY OR NON-ABS)	Mod. KA, HS Eng. C27A			02-87	04-91	3499	K	28	34	60		M			



CHASSIS ↑

→ CHASSIS

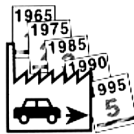

G L O N .

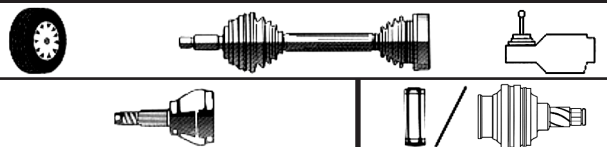

XXXX	K	A	B	C	ABS	P	XXXX	K	A	B	C
------	---	---	---	---	-----	---	------	---	---	---	---

HONDA

3.2i V6 24V (ABS READY OR NON ABS) Eng. C32A			05-91		3499	K	28	34	60		M								
PRELUDE																			
1.6 SN Eng. EL			01-78	12-82	3015	K	23	22	45		I								
1.6 SN Eng. EL			01-83	12-83	3060	K	24	22	45		M								
1.8 SN 66 kW (90 HP), EK			01-81	12-82	3060	K	24	22	45		M								
2.0 16V Mod.BA4-BA5 Eng.B20A			10-87	12-91	3180	K	28	32	60		M								
2.0 16V Si (USA)			01-90	12-92	3180	K	28	32	60		M								
2.0 16V Si (USA) DOHC			01-92	12-93	3180	K	28	32	60		M								
2.0 Si, BA 4/5 110 kW (150 HP), B20A			01-89		3220	K	26	32	55		M								
2.0i 16V 99/101 (135-137 HP)			01-85	12-88	3581	K	26	32	49		M								
AB A.T. ES 1800			01-82	12-87	3581	K	26	32	49		M								
AB M.T. ES 1800			01-82	12-87	3083	K	24	30	47		M								
AB M.T. ES 1800			01-84	12-87	3581	K	26	32	49		M								
AB, BB ES 1800			01-84	12-87	3581	K	26	32	49		M								
BA1 B20A 2000			01-85	12-87	3581	K	26	32	49		M								
BA4, BA5 (NO ALB) B20A 2000			01-87	12-89	3220	K	26	32	55		M								
DX			01-83	12-83	3083	K	24	30	47		M								
DX 4 SPEED, A.T.			01-84	12-87	3083	K	24	30	47		M								
DX 5 SPEED, M.T.			01-84	12-87	3083	K	24	30	47		M								
Si 4 SPEED, A.T.			01-85	12-87	3581	K	26	32	49		M								
Si 5 SPEED, M.T.			01-85	12-87	3581	K	26	32	49		M								
Si, A.T.			01-86	12-87	3105	K	26	32	49		M								
Si, M.T.			01-84	12-87	3581	K	26	32	49		M								
SN EK 1800			01-81	12-82	3060	K	24	22	45		M								
SN100 EK 1800			01-78	12-80	3556	K	23	22	45		M								
TT			01-79	12-80	3556	K	23	22	45		M								
TT			01-81	12-82	3060	K	24	22	45		M								
TT			01-83	12-84	3083	K	24	30	47		M								
TT (NO Si)			01-85	12-87	3083	K	24	30	47		M								
PRELUDE																			
2.0 ABS Mod. BA4, 5 Eng. B20A			87	89	3434	K	26	32	55	50	M								
2.0 ABS A.T./M.T. Mod. S, Si, SIHWS 78/85 kW (106-115 HP)			89		3434	K	26	32	55	50	M								
2.0 ABS A.T./M.T. Mod. S, Si, 4WSSI Eng. BA4, 5 111 kW (151 HP)			89		3434	K	26	32	55	50	M								
QUINTET (A.T.-M.T.)																			
1.6 EX Eng.EL 59 kW (80 HP)			02-80	12-84	3556	K	23	22	45		M								
TODAY																			
JA2			09-91		3197	K	23	21	49		I								
JA3 4WD			09-91		3197	K	23	21	49		I								
JA4 EO7A 660			01-93		3197	K	23	21	49		I								
JW1 EH			01-85		3425	K	23	18	49		M								
JW2 EO5A			03-88		3196	K	23	19	49		I								
JW2 EO5A			03-90		3196	K	23	19	49		I								
JW3 EO7A 660			03-90		3197	K	23	21	49		I								
JW4 4WD EO7A 660			03-90		3197	K	23	21	49		I								
JW5 4WD EO7A 660			01-93		3197	K	23	21	49		I								



	CHASSIS →	→ CHASSIS		G L O N .																
				XXXX	K	A	B	C	ABS	P						XXXX	K	A	B	C







HYUNDAI

Model	Year 1	Year 2	XXXX	K	A	B	C	ABS	P	XXXX	K	A	B	C
ELANTRA														
1.6 ABS	95		3454	K	25	30	50	29	M					
1.8 ABS	95		3455	K	25	23	50	29	M					
2.0 ABS	95		3455	K	25	23	50	29	M					
EXCEL														
1,3 50/55 kW (67-75 HP) - G4AG/4G15	10-85	10-89	3044	K	25	22	50		M					
1,5 51/63 kW (70-85 HP) - G4AG/4G15	10-85	10-89	3044	K	25	22	50		M					
LANTRA														
1,5 Mod. KM Eng. 4G	01-91	12-93	3124	K	25	25	50		M					
1,8 Mod. KM Eng. 4G	01-91	12-93	3124	K	25	25	50		M					
PONY M.T.														
1,3 50/55 kW (67-75 HP) - G4AG	10-85	10-89	3044	K	25	22	50		M					
1,5 51/63 kW (70-85 HP) - G4AJ	10-85	10-89	3044	K	25	22	50		M					
S-COUPE'														
TT	01-91	12-92	3044	K	25	22	50		M					
SCOUPE														
TT (NO TURBO)	90	93	3044	K	25	22	50		M					
TT TURBO	90	93	3217	K	25	23	50		M					
SONATA														
3.0 V6 100AC (USA)	89	91	3461	K	25	26	50		M					
TT (SX) G4CP	01-88	12-91	3217	K	25	23	50		M					
TT (DX) G4CP	01-88	12-91	3124	K	25	25	50		M					

INNOCENTI

Model	Year 1	Year 2	XXXX	K	A	B	C	ABS	P	XXXX	K	A	B	C
ELBA														
1.4, 1.6, 1.7D	01-91		3504	K	22	20	48		E					
KORAL														
55	01-89		3501	K	20	20	43,1		E					
MILLE														
R/89	01-94		3501	K	20	20	43,1		E					
MILLE														
1.0, 1.4, 1.7D	01-91		3504	K	22	20	48		E					
MINI														
TT	01-87		3009	K	29	19	48		I					



	CHASSIS ↑	↓ CHASSIS		G L O N .																		
																						
XXXX	K	A	B	C	ABS	P	XXXX	K	A	B	C											







ISO																							
ISIGO 500																							

ISUZU																							
GEMINI 1-MARK (A.T. - M.T.)																							
1.5 (DX) (NO TURBO)	JT190/4XC1			01-85	12-89	3182	K	22	21	50													
1.5 (DX) (NO TURBO)	JT600/4EC1			01-85	12-87	3182	K	22	21	50													
1.5 (DX) (NO TURBO)	JT600 NAV15/4EC1			01-88		3182	K	22	21	50													
1.5 (SX) (NO TURBO)	JT150/4XEC			01-85	12-89	3181	K	22	22	50													
1.5 (SX) (NO TURBO)	JT600/4EC1			01-85	12-87	3181	K	22	22	50													
1.5 (SX) (NO TURBO)	JT600 NAV15/4EC1			01-88		3181	K	22	22	50													

JDM																							
TITANE																							

KIA																								
PRIDE (M.T.)																								
1.1	B3			06-91		3371	K	24	19	52														
1.3	B3			06-91		3371	K	24	19	52														
SEPHIA (M.T.)																								
1.5i 16V	Eng. B5 59 kW (80 HP)			02-96	10-97	3238	K	26	22	56														
1.6i	Eng. B6 59 kW (80 HP)			09-93		3238	K	26	22	56														



	CHASSIS →	→ CHASSIS		G L O N .										
				  			XXXX	K	A	B	C	ABS	P	XXXX

LADA

NIVA																	
1,6	56/59 kW (76-80 HP)		07-78		3120	K	22	22	56		I						
VAZ 2121			07-78		3120	K	22	22	56		I						
SAMARA																	
1,1	40 kW (55 HP)		01-86		3107	K	22	22	50		I						
1,3	48 kW (65 HP)		01-86		3107	K	22	22	50		I						
1,5	55 kW (75 HP)		01-86		3107	K	22	22	50		I						
TAIGA																	
TT					3120	K	22	22	56		I						

LAMBORGHINI

DIABLO																	
VT, SV, VT ROADSTER RWD			90		4501	K		28	108			4501	K		28	108	

LANCIA

DEDRA																	
1.3			01-92	07-94	3667	K	22	20	46		E						
1.5			01-92	07-94	3667	K	22	20	46		E						
1.6	57/59 kW (78-80 HP)		04-89		3667	K	22	20	46		E						
1.6			07-94		3667	K	22	20	46		E						
1.6 ABS			07-94		3168	K	22	20	46	44	E						
1.8	77/79 kW (105-107 HP)		04-89	06-94	3706	K	25	25	52		I	4512	K		25	100	
1.8			07-94		3706	K	25	25	52		I						
1.8 ABS	77/79 kW (105-107 HP)		04-89	06-94	3671	K	25	25	52	90	I	4512	K		25	100	
1.8 ABS			07-94		3673	K	25	25	52	44	I						
2.0			01-90		3706	K	25	25	52		I						
2.0			01-92		3706	K	25	25	52		I	4512	K		25	100	
2.0 ABS			04-89		3673	K	25	25	52	44	I	4512	K		25	100	



CHASSIS ↑

→ CHASSIS

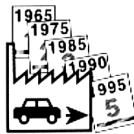
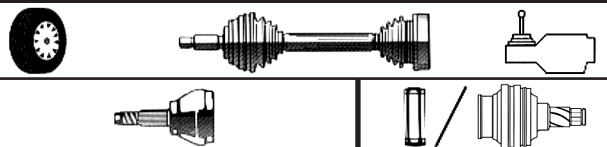
**G L O N .**

XXXX	K	A	B	C	ABS	P	XXXX	K	A	B	C
------	---	---	---	---	-----	---	------	---	---	---	---

LANCIA

Model		Power (kW)	Year 1	Year 2	Code	K	A	B	C	ABS	P	Code	K	A	B	C
DEDRA DIESEL																
1.9 TURBO DIESEL	66/68 kW (90-92 HP)		04-89		3706	K	25	25	52		I	4512	K		25	100
1.9 TURBO DIESEL ABS	66/68 kW (90-92 HP)		04-89	12-92	3671	K	25	25	52	90	I	4512	K		25	100
1.9 TURBO DIESEL ABS	66/68 kW (90-92 HP)		01-93		3673	K	25	25	52	44	I	4512	K		25	100
DELTA																
1.3	55/57 kW (75-78 HP)		09-79	05-91	3504	K	22	20	48		E					
1.3			01-92	07-94	3667	K	22	20	46		E					
1.3 ABS			01-92	07-94	3168	K	22	20	46	44	E					
1.5			01-92	07-94	3667	K	22	20	46		E					
1.5	63 kW (85 HP)				3012	K	22	25	48		I	4512	K		25	100
1.5 ABS			01-92	07-94	3168	K	22	20	46	44	E					
1.6	66/79 kW (90-108 HP)		09-79		3012	K	22	25	48		I	4512	K		25	100
1.8			01-92		3706	K	25	25	52		I					
1.8 ABS			01-92		3673	K	25	25	52	44	I					
2.0			01-90		3706	K	25	25	52		I					
2.0 ABS			01-92		3673	K	25	25	52	44	I					
DELTA 4WD																
2.0 ABS	132/147 kW (180-200 HP)		11-87		3671	K	25	25	52	90	I					
HPE																
1.6	73 kW (100 HP)		01-79	12-84	3706	K	25	25	52		I					
2.0	89/90 kW (120-122 HP)		01-79	12-84	3706	K	25	25	52		I					
KAPPA																
2.0 ABS			10-94		3251	K	27	25	60	44	I					
2.4 ABS			10-94		3251	K	27	25	60	44	I					
2.4 TURBO DIESEL ABS			10-94		3250	K	27	28	56	44	E					
3.0 V6 ABS			10-94		3250	K	27	28	56	44	E					
MONTECARLO																
2.0	89 kW (120 HP)		01-75	12-84								4512	K		25	100
PRISMA (A.T.)																
1.5	59 kW (80 HP)		12-82	12-89	3012	K	22	25	48		I					
PRISMA (M.T.)																
1.3	55/57 kW (75-78 HP)		12-82	12-89	3504	K	22	20	48		E					
1.5	59 kW (80 HP)		12-82	12-89	3504	K	22	20	48		E					
1.6	77 kW (105 HP)		12-82	12-89	3012	K	22	25	48		I	4512	K		25	100
PRISMA DIESEL																
1.9 TURBO DIESEL	48 kW (65 HP)		06-84	12-89	3012	K	22	25	48		I	4512	K		25	100
1.9 TURBO DIESEL ABS	59 kW (80 HP)		05-85	12-89	3012	K	22	25	48		I	4512	K		25	100
PRISMA 4WD																
2.0	82/85 kW (112-115 HP)		01-86	12-89								4512	K		25	100
THEMA																
2.0	83/121 kW (113-165 HP)		11-84	10-92	3706	K	25	25	52		I					
2.0	83/121 kW (113-165 HP)		10-92		3245	K	27	25	56		I					
2.0 ABS	83/121 kW (113-165 HP)		176744	11-84	10-92	3671	K	25	25	52	90	I				
2.0 ABS	83/121 kW (113-165 HP)			10-92		3246	K	27	25	56	44	I				
2.5, 2.8 V6	110 kW (150 HP)		11-84	10-92	3706	K	25	25	52		I					
2.5, 2.8 V6	110 kW (150 HP)		10-92		3245	K	27	25	56		I					



	CHASSIS →	→ CHASSIS		G L O N .											
				XXXX	K	A	B	C	ABS	P	XXXX	K	A	B	C

LANCIA

2.5, 2.8 V6 ABS	110 kW (150 HP)		176744	11-84	10-92	3671	K	25	25	52	90	I				
2.5, 2.8 V6 ABS	110 kW (150 HP)			10-92		3246	K	27	25	56	44	I				
2.5, 2.8 V6 ABS	110 kW (150 HP)	176745			10-92	3671	K	25	25	52	90	I				
3.0 8,32	158 kW (215 HP)			04-86		3248	K	27	28	56		E				
3.0 V6	126/129 kW (171-175 HP)			09-92		3245	K	27	25	56		I				
3.0 V6 ABS	126/129 kW (171-175 HP)			09-92		3246	K	27	25	56	44	I				
6V FERRARI/PROTECTA						3248	K	27	28	56		E				
6V FERRARI/PROTECTAABS						3749	K	27	28	56	90	E				
TREVI																
1,6	(100 HP)			01-80	12-84								4512	K		25 100
2.0	(115-80 HP)			01-80	12-84								4512	K		25 100
Y																
1.2, 1.4				02-96		3667	K	22	20	46		E				
1.4 ABS				02-96		3168	K	22	20	46	44	E				
Y 10																
AVENUE 1.1	40 kW (54 HP)			01-95		3501	K	20	20	43,1		E				
AVENUE 1.1 4WD (Front)	40 kW (54 HP)			01-95		3501	K	20	20	43,1		E				
FIRE 1.0	32/33/37 kW (43-45-50 HP)			06-85	02-92	3501	K	20	20	43,1		E				
FIRE 1.0 4WD (Front)	32/37 kW (43-50 HP)			12-86	02-90	3501	K	20	20	43,1		E				
FIRE 1.1	37 kW (50 HP)			07-89		3501	K	20	20	43,1		E				
FIRE 1.1i.e. 4WD (Front)	37 kW (50 HP)			09-92		3501	K	20	20	43,1		E				
FIRE 1.3i.e.	53/56 kW (72-76 HP)			11-87	05-93	3501	K	20	20	43,1		E				
Z																
2.0i. TURBO ABS	108 kW (147 HP)			08-94		3288	K	27	39	59	48	I				
2.1 TURBO DIESEL 12V ABS	80 kW (109 HP)			08-96		3288	K	27	39	59	48	I				

LEXUS

ES 250																
TT				90	91	3295	K	26	27	56		I				



↑ CHASSIS

→ CHASSIS

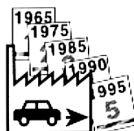

G L O N .

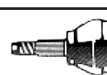

XXXX	K	A	B	C	ABS	P	XXXX	K	A	B	C
------	---	---	---	---	-----	---	------	---	---	---	---

LIGIER

Model	Year	XXXX	K	A	B	C	ABS	P	XXXX	K	A	B	C
AMBRA		3115	K	18	18	42		E	4015	K	18	18	62



LINCOLN CONTINENTAL (FORD USA)

Model	Year	XXXX	K	A	B	C	ABS	P	XXXX	K	A	B	C
CONTINENTAL													
3.8 (A.T.) ABS	01-88 12-92	3161	K	26	32	55,8	50	I					

MASERATI

Model	Year	XXXX	K	A	B	C	ABS	P	XXXX	K	A	B	C
GHIBLI													
2.0 RWD	92	4401	K		28	108			4401	K		28	108
2.8 RWD	92	4401	K		28	108			4401	K		28	108
QUATTROPORTE													
2.0 RWD	94	4401	K		28	108			4401	K		28	108
2.8 RWD	94	4401	K		28	108			4401	K		28	108
3.2 RWD	94	4401	K		28	108			4401	K		28	108

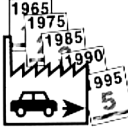

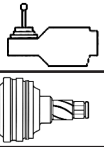
		CHASSIS →	→ CHASSIS		G L O N .																
																					
XXXX	K	A	B	C	ABS	P	XXXX	K	A	B	C										
MAZDA																					
ASTINA																					
1.5	DOHC - B5/BP		01-89	12-93	3238	K	26	22	56		I										
1.6i 16V	B6/BP		01-89	12-93	3238	K	26	22	56		I										
1.8i 16V	B6/BP		01-89	12-93	3238	K	26	22	56		I										
1.8i 16V	(ABS READY OR NON-ABS)		12-93		3299	K	26	30	56		I										
1.8i 16V ABS			12-93		3409	K	26	30	56	44	I										
CAPELLA (M.T.)																					
2.0	Mod. GD (EA, EB, EP, ES) Eng. FE/RF		11-87	07-91	3322	K	28	26	56		I										
2.2 12V	Mod. GD (EA, EB, EP, ES) Eng. FE/RF		11-87	07-91	3322	K	28	26	56		I										
LANTIS																					
1.8i 16V	(ABS READY OR NON-ABS)		12-93		3299	K	26	30	56		I										
1.8i 16V ABS			12-93		3409	K	26	30	56	44	I										
MIATA																					
1.6 (A.T.)			01-89	12-92	3376	K	26	22	56		I										
1.6 (M.T.)			01-89	12-92	3376	K	26	22	56		I										
MX3																					
1.5	DOHC - B5/BP		01-91	12-93	3238	K	26	22	56		I										
1.6i 16V	B6/BP		01-91	12-93	3238	K	26	22	56		I										
1.8i 16V	B6/BP		01-91	12-93	3238	K	26	22	56		I										
MX-3 (A.T./M.T.)																					
1.6i	Mod. EC Eng. B69 65 kW (88 HP)		07-91		3238	K	26	22	56		I										
6-CYL ABS			01-92	12-94	3409	K	26	30	56	44	I										
MX-6 (M.T.)																					
1.6	Mod. GD (6P) Eng. B6		01-88		3176	K	26	25	56		M										
1.8	Mod. GD (8P) Eng. F8		01-88		3176	K	26	25	56		M										
2.0	Mod. GD (EA, EB, EP, ES) Eng. FE/RF		11-87	07-91	3322	K	28	26	56		I										
2.2 12V	Mod. GD (EA, EB, EP, ES) Eng. FE/RF		11-87	07-91	3322	K	28	26	56		I										
MX-6 (A.T./M.T.)																					
2.5 24V	Mod. GE6 Eng. KL 121 kW (164 HP)		02-92		3322	K	28	26	56		I										
2.5i 24V	Mod. GE6 Eng. KL 120 kW (163 HP)		08-94		3322	K	28	26	56		I										
PROCEED B2600																					
4WD Mod. 95LAC WAGON			87	92	3470	K	26	25	65		M										
PROTEGE																					
SOHC			01-90	12-91	3228	K	26	23	56		M										
PROTEGE (A.T./M.T.)																					
1.8L ABS			01-95		3409	K	26	30	56	44	I										
TELSTAR																					
1.6 - 1.8			09-87	03-90	3267	K	26	23	56		M										
121 FESTIVA																					
DA1	B1 1100		01-85	12-89	3371	K	24	19	52		M										
DA3	B3 1300		01-85	12-89	3371	K	24	19	52		M										
DA3 (A.T.)	B3 1300		01-86		3371	K	24	19	52		M										
DA3 (M.T.)	B3 1300		01-89		3372	K	24	20	52		M										
DAJ (M.T.)	BJ 1300		01-86		3372	K	24	20	52		M										
DOHC (M.T.)	BJ 1300		01-86		3372	K	24	20	52		M										



CHASSIS ↑

→ CHASSIS

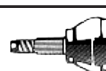





**G L O N .**

XXXX	K	A	B	C	ABS	P	XXXX	K	A	B	C
------	---	---	---	---	-----	---	------	---	---	---	---

MAZDA

323																	
1.8 16V				01-90			3286	K	26	30	56		I				
1.8i 16V (ABS READY OR NON-ABS)				12-93			3299	K	26	30	56		I				
1.8i 16V ABS				12-93			3409	K	26	30	56	44	I				
323 (COLOMBIA)																	
1,3							3331	K	24	30	52		E				
1.5 (SX)							3331	K	24	30	52		E				
323, FAMILIA, & GLC																	
1.1 M.T. 41 kW (55 HP) - E1				06-80	07-85		3035	K	24	22	52		M				
1.3 A.T. 47 kW (64 HP) - B3/E3				05-85	09-89		3035	K	24	22	52		M				
1.3 M.T. 44/50 kW (60-68 HP) - E3				06-80	07-85		3035	K	24	22	52		M				
1.3 M.T. 50/56 kW (68-76 HP)				01-89			3238	K	26	22	56		I				
1.3 (INTERNATIONAL)				01-86			3145	K	24	21	52		M				
1.4 A.T. E3				04-87	09-89		3035	K	24	22	52		M				
1.5 A.T. 54/55 kW (73-75 HP) - B5/E5				08-85	09-89		3035	K	24	22	52		M				
1.5 M.T. 54/55 kW (73-75 HP) - B5/E5				08-85	08-89		3035	K	24	22	52		M				
1.5 M.T. 55/63 kW (75-85 HP) - E5				06-80	07-85		3035	K	24	22	52		M				
1.5 (INTERNATIONAL)				01-86			3145	K	24	21	52		M				
1.6 A.T. 62/77 kW (85-105 HP) - B6				08-85	09-89		3035	K	24	22	52		M				
1.6 M.T. 62 kW (85 HP)				01-89			3238	K	26	22	56		I				
1.7 DIESEL 43 kW (58 HP) - PN/PN27				01-87	09-89		3035	K	24	22	52		M				
1.8i 16V (ABS READY OR NON-ABS)				12-93			3299	K	26	30	56		I				
1.8i 16V ABS				12-93			3409	K	26	30	56	44	I				
1.9 16V Eng. BP AT/MT 76 kW (103 HP)				04-91	07-94		3267	K	26	23	56		M				
AWD HATCHBACK				01-88	12-89		3145	K	24	21	52		M				
BF3P A.T. B3 1500				01-84	12-87		3035	K	24	22	52		M				
BF5P (NO TURBO) E5 1500				01-85	12-87		3035	K	24	22	52		M				
BF5P TURBO M.T. E5 1500				01-85	12-87		3144	K	24	23	52		M				
BF5W, BF5V E5 1500				01-85	12-87		3035	K	24	22	52		M				
BF7P A.T. PN 1700				01-85	12-89		3035	K	24	22	52		M				
BF7V, BF7P M.T. PN 1700				01-87	12-89		3035	K	24	22	52		M				
BFMP M.T. E6 1600				01-85	12-89		3144	K	24	23	52		M				
BFMP, BFMS B6 1600				01-85	12-89		3035	K	24	22	52		M				
BFSP B5 1500				01-87	12-89		3035	K	24	22	52		M				
BFTP A.T. B3 1300				01-87	12-89		3035	K	24	22	52		M				
BG3P, BG3S B3 1300				01-89			3239	K	26	21	56		I				
BG5P, BG5S B5 1500				01-89			3238	K	26	22	56		I				
BG5P, BG5S (NO DOHC) B5 1500				01-89			3239	K	26	21	56		I				
BG6P, BG6S B6 1600				01-89			3238	K	26	22	56		I				
BG7P, A11 PN 1700				01-89			3239	K	26	21	56		I				
E-BD 1031 E3 1300				01-80	12-85		3035	K	24	22	52		M				
TT				01-82	12-85		3035	K	24	22	52		M				
626																	
1.6 A.T. B6				01-88			3267	K	26	23	56		M				
1.6 M.T. B6				01-88			3176	K	26	25	56		M				
1.8 A.T. 65 kW (88 HP) - F8				11-87	05-92		3267	K	26	23	56		M				



	CHASSIS →	→ CHASSIS		G L O N .										
														
														
XXXX	K	A	B	C	ABS	P	XXXX	K	A	B	C			

MAZDA

1.8 M.T.	65 kW (88 HP) - F8			11-87	05-92	3176	K	26	25	56		M								
1.8 A.T.	69 kW (94 HP)			11-87	05-92	3267	K	26	23	56		M								
1.8 M.T.	69 kW (94 HP)			11-87	05-92	3176	K	26	25	56		M								
1.8 COUPE' A.T.	65 kW (88 HP) - F8			09-87	08-91	3267	K	26	23	56		M								
1.8 COUPE' M.T.	65 kW (88 HP) - F8			09-87	08-91	3176	K	26	25	56		M								
1.8i ABS A.T./M.T.	Mod. GE8P, GEEP Eng. FP, K8 77 kW (105 HP)			08-91	04-97	3496	K	28	23	56	44	I								
2.0, 2.0 COUPE' (M.T.)	66 kW (90 HP) - FE			09-87	10-90	3176	K	26	25	56		M								
2.0 12V, 16V (A.T.)	79/103 kW (107-140 HP) - FE			11-87	05-92	3176	K	26	25	56		M								
2.0 12V, 16V (M.T.)	79/103 kW (107-140 HP) - FE			11-87	05-92	3322	K	28	26	56		I								
2.0 12V, 16V, COUPE' (A.T.)	79/103 kW (107-140 HP) - FE			11-87	10-90	3176	K	26	25	56		M								
2.0 12V, 16V, COUPE' (M.T.)	79/103 kW (107-140 HP) - FE			11-87	10-90	3322	K	28	26	56		I								
2.0 DIESEL A.T.	44 kW (60 HP) - RFB			07-87	07-91	3176	K	26	25	56		M								
2.0 DIESEL M.T.	44 kW (60 HP) - RFB			07-87	07-91	3322	K	28	26	56		I								
2.0i, 4WD, ABS A.T./M.T.	Mod. GE8P, GEEP Eng. FS, KF 85 kW (115 HP)			08-91	04-97	3496	K	28	23	56	44	I								
2.0 STATION WAGON A.T.	66 kW (90 HP) - FE			10-88	10-90	3176	K	26	25	56		M								
2.0 STATION WAGON M.T.	66 kW (90 HP) - FE			10-88	10-90	3322	K	28	26	56		I								
2.0 STATION WAGON 16V A.T.	103 kW (140 HP) - FE			01-88	03-92	3176	K	26	25	56		M								
2.2 12V A.T.	85 kW (115 HP) - F2			11-87	04-92	3176	K	26	25	56		M								
2.2 12V M.T.	85 kW (115 HP) - F2			11-87	04-92	3322	K	28	26	56		I								
2.2 4 CYL. 16V GLX				92	94	3321	K	28	23	56		I								
2.2 12V COUPE' A.T.	85 kW (115 HP) - F2			03-90	12-91	3176	K	26	25	56		M								
2.2 12V COUPE' M.T.	85 kW (115 HP) - F2			03-90	12-91	3322	K	28	26	56		I								
2.2 STATION WAGON 12V A.T.	85 kW (115 HP) - F2			03-89	10-90	3176	K	26	25	56		M								
2.2 STATION WAGON 12V M.T.	85 kW (115 HP) - F2			03-89	10-90	3322	K	28	26	56		I								
626 (A.T./M.T.)																				
2.5 24V	Mod. GE Eng. KL 120/121 kW (163-164 HP)			08-94	04-97	3322	K	28	26	56		I								
626, CAPELLA, MX-6																				
1.6	60 kW (81 HP) - F6			10-82	06-87	3178	K	26	23	52		M								
1.6	54/60 kW - B6			09-87	12-92	3267	K	26	23	56		M								
1.8	60/71 kW - F8			09-87	12-92	3267	K	26	23	56		M								
1.8 A.T.	70/74 kW (95-100 HP) - F8			10-82	06-87	3178	K	26	23	52		M								
1.8 M.T.	70/74 kW (95-100 HP)			10-82	06-87	3178	K	26	23	52		M								
2.0 COUPE' M.T.	68/88 kW (93-120 HP) - FE/EGi			01-83	06-87	3034	K	26	25	52		M								
2.0 M.T.	68/88 kW (93-120 HP) - FE/EGi			10-82	06-87	3034	K	26	25	52		M								
4 CYL. (Mazuri 2000)	(ABS READY OR NON-ABS)			01-94		3321	K	28	23	56		I								
6 CYL. (Mazuri 2000)	(ABS READY OR NON-ABS)			01-94		3322	K	28	26	56		I								
6 CYL. (Mazuri 2000) ABS				01-94		3410	K	28	26	56	44	I								
626 TURBO (Cronos South Africa)				01-88	12-92	3322	K	28	26	56		I								
626 V6				01-88	12-92	3322	K	28	26	56		I								
626 V6 ABS				01-88	12-92	3410	K	28	26	56	44	I								
GC6P	F6 1600			01-82	12-87	3178	K	26	23	52		M								
GC8P	F8 1800			01-82	12-87	3178	K	26	23	52		M								
GCEP	FE 2000			01-82	12-87	3034	K	26	25	52		M								
GCFP	RE 2000			01-82	12-87	3034	K	26	25	52		M								
GDEP-EA GDES-EB MT	FE 2.0 - FR 2.0 - 1.8 - 2.0D			01-87	12-91	3176	K	26	25	56		M								
TT				01-83	12-87	3034	K	26	25	52		M								



CHASSIS ↑

→ CHASSIS



G L O N .

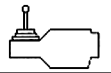
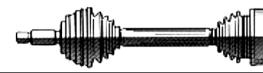

XXXX	K	A	B	C	ABS	P	XXXX	K	A	B	C
------	---	---	---	---	-----	---	------	---	---	---	---









MAZDA

626, CAPELLA, TELSTAR (SOUTH AFRICA)																		
626	2.0 (ABS READY OR NON-ABS)		01-90	12-92	3279	K	26	25	56		M							
626	2,2 (ABS READY OR NON-ABS)				3279	K	26	25	56		M							
626 ABS	2.0		01-90	12-92	3414	K	26	25	56	90	M							
626 ABS CA5	2,2		01-90	12-92	3414	K	26	25	56	90	M							
626 SERIE II	2,2		01-87	12-90	3176	K	26	25	56		M							
626 TURBO			01-88	12-92	3322	K	28	26	56		I							
626 V6			01-88	12-92	3322	K	28	26	56		I							
626 V6 ABS			01-88	12-92	3410	K	28	26	56	44	I							
FORD TELSTAR 4CYL. (ABS READY OR NON-ABS)			01-94		3321	K	28	23	56		I							
FORD TELSTAR 6 CYL. ABS			01-94		3410	K	28	26	56	44	I							
FORD TELSTAR 6CYL. (ABS READY OR NON-ABS)			01-94		3322	K	28	26	56		I							
FORD TELSTAR AT/AV	2,2		01-87	12-90	3176	K	26	25	56		M							

MERCEDES-BENZ

VIANO (M.T.)																		
1.8	80 kW (109 HP)		02-96		3500	K	27	27	60	48	I							
2.4	105 kW (143 HP)		12-96		3500	K	27	27	60	48	I							
VIANO 108 DIESEL (M.T.)																		
2.3	58 kW (101 HP)		02-96		3500	K	27	27	60	48	I							
VIANO V200 (A.T./M.T.)																		
2.0	95 kW (129 HP)	VSA638014	VSA638294		3453	K	27	27	60		I							
2.0 ABS	95 kW (129 HP)	VSA638014	VSA638294		3500	K	27	27	60	48	I							
VIANO V220 CDI (A.T./M.T.)																		
2.2 TURBO DIESEL ABS	90 kW (122 HP)	VSA638014	VSA638294		3500	K	27	27	60	48	I							
VIANO V230 (A.T./M.T.)																		
2.3 ABS	105 kW (143 HP)	VSA638014	VSA638294		3500	K	27	27	60	48	I							
2.3 TURBO DIESEL	72 kW (98 HP)	VSA638014	VSA638294		3453	K	27	27	60		I							
2.3 TURBO DIESEL ABS	72 kW (98 HP)	VSA638014	VSA638294		3500	K	27	27	60	48	I							
VITO (638) M.T.																		
2.0 113	95 kW (129 HP)		02-96		3453	K	27	27	60		I	4501	K		28	108		
2.3 114	105 kW (143 HP)		12-96		3453	K	27	27	60		I	4501	K		28	108		
2.3 DIESEL, TD 108, 110			02-96		3453	K	27	27	60		I	4501	K		28	108		
VITO (M.T.)																		
1.8 ABS	80 kW (109 HP)		02-96		3500	K	27	27	60	48	I							
VITO 108 CDI (A.T./M.T.)																		
2.2 TURBO DIESEL	60 kW (82 HP)	VSA638014	VSA638294		3453	K	27	27	60		I							
2.2 TURBO DIESEL ABS	60 kW (82 HP)	VSA638014	VSA638294		3500	K	27	27	60	48	I							



	CHASSIS →	← CHASSIS		G L O N .										
				  		 	XXXX	K	A	B	C	ABS	P	XXXX



MERCEDES-BENZ

VITO 108 D (A.T./M.T.)																	
2.3 DIESEL	58 kW (79 HP)	VSA638014	VSA638294														
2.3 DIESEL ABS	58 kW (79 HP)	VSA638014	VSA638294														
VITO 110 CDI (A.T./M.T.)																	
2.2 TURBO DIESEL	75 kW (102 HP)	VSA638014	VSA638294														
2.2 TURBO DIESEL ABS	75 kW (102 HP)	VSA638014	VSA638294														
VITO 110 D (A.T./M.T.)																	
2.3 TURBO DIESEL	72 kW (98 HP)	VSA638014	VSA638294														
2.3 TURBO DIESEL ABS	72 kW (98 HP)	VSA638014	VSA638294														
VITO 112 CDI (A.T./M.T.)																	
2.2 TURBO DIESEL	90 kW (122 HP)	VSA638014	VSA638294														
2.2 TURBO DIESEL ABS	90 kW (122 HP)	VSA638014	VSA638294														
VITO 113 (A.T./M.T.)																	
2.0	95 kW (129 HP)	VSA638014	VSA638294														
2.0 ABS	95 kW (129 HP)	VSA638014	VSA638294														
VITO 114 (A.T./M.T.)																	
2.3 ABS	105 kW (143 HP)	VSA638014	VSA638294														

MERCURY (FORD USA)

LYNX & LN7																	
TT			01-81	12-82	3022		23	23	55								
TT			01-86	12-87	3023	K	26	23	51,1								
TT (NO TURBO)			01-84	12-85	3023	K	26	23	51,1								
TT TURBO			01-84	12-84	3078	K	26	32	51,1								
TT TURBO			01-85	12-85	3023	K	26	23	51,1								
TT, A.T.			01-83	12-83	3022		23	23	55								
TT, M.T.			01-83	03-83	3022		23	23	55								
TT, M.T.			04-83	12-83	3023	K	26	23	51,1								
SABLE																	
3.0 V-6			01-86	12-92	3062	K	26	30	55,82								
3.8 V-6			01-88	12-92	3102	K	26	32	55,8								
3.8 V-6, ABS			01-88	12-92	3161	K	26	32	55,8	50							
4 CYL, A.T.			01-86	12-86	3062	K	26	30	55,82								
TOPAZ																	
DIESEL			01-85	12-86	3023	K	26	23	51,1								
DIESEL, 5 SPEED, M.T.			01-84	12-84	3023	K	26	23	51,1								
TT			01-86	12-91	3387	K	26	24	50								

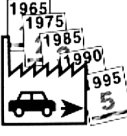

	CHASSIS ↑	→ CHASSIS		G L O N .												
																
				XXXX	K	A	B	C	ABS	P	XXXX	K	A	B	C	
MERCURY (FORD USA)																
TT 4 SPEED, M.T.			01-84	12-84	3023	K	26	23	51,1		I					
TT 5 SPEED, M.T. (NO DIESEL)			03-83	12-84	3078	K	26	32	51,1		I					
TT, A.T.			01-84	12-91	3023	K	26	23	51,1		I					
TT, M.T. (NO DIESEL)			01-85	12-91	3023	K	26	23	51,1		I					
TT, M.T. (NO DIESEL)			01-85	12-85	3078	K	26	32	51,1		I					
			84	85	3448	K	26	23	51,1		I					
TRACER																
1,6			01-88	12-89	3035	K	24	22	52		M					
MICROCAR																
LYRA 505					3115	K	18	18	42		E	4015	K	18	18	62
VIRGO					3115	K	18	18	42		E	4015	K	18	18	62
MITSUBISHI																
CHAMP, COLT, MIRAGE																
1200	C15 (INTERNAL GROOVE)		01-84	12-88	3044	K	25	22	50		M					
1200 GL, EL	A15 (INTERNAL GROOVE)		01-79	12-83	3044	K	25	22	50		M					
1400 GT, GLX	A15 (INTERNAL GROOVE)		01-79	12-83	3044	K	25	22	50		M					
1400 TURBO			09-81	12-83	3217	K	25	23	50		M					
1500 DIESEL	C12, C14 (INTERNAL GROOVE)		01-84	12-88	3044	K	25	22	50		M					
1500 GLX	C12 (INTERNAL GROOVE)		01-84	12-88	3044	K	25	22	50		M					
1600 TURBO	C15		01-84	12-88	3217	K	25	23	50		M					
1800 DIESEL	C12, C14 (INTERNAL GROOVE)		01-84	12-88	3044	K	25	22	50		M					
A152, A153	G11B 1200 (INTERNAL GROOVE)		01-78	12-83	3044	K	25	22	50		M					
A155, A151	G32B 1600 (INTERNAL GROOVE)		01-78	12-83	3044	K	25	22	50		M					
A156, A157	G12B 1400 (INTERNAL GROOVE)		01-78	12-83	3044	K	25	22	50		M					
CHARIOT SPACEWAGON																
1800			01-83		3142	K	25	23	50		M					



	CHASSIS →	→ CHASSIS		G L O N .										
				XXXX	K	A	B	C	ABS	P	XXXX	K	A	B
MITSUBISHI														
1800 DIESEL			01-83		3142	K	25	23	50		M			
D04W	4G63 2.000		10-86	11-91	3142	K	25	23	50		M			
D05W	G37 1800 (INTERNAL GROOVE)		01-84		3044	K	25	22	50		M			
D08W 4WD	G63B 2000		01-84	12-86	3124	K	25	25	50		M			
D09W, 1800 TURBO DIESEL	4D65 1800		01-84		3142	K	25	23	50		M			
COLT, LANCER, MIRAGE														
1.6 TURBO			01-85	12-86	3142	K	25	23	50		M			
C11	G13B 1300 (INTERNAL GROOVE)		01-83	12-87	3044	K	25	22	50		M			
C12	G15B 1500 (INTERNAL GROOVE)		01-83	12-87	3044	K	25	22	50		M			
C14	4D65 1800 (INTERNAL GROOVE)		01-83	12-85	3044	K	25	22	50		M			
C14	4D54 1800 (INTERNAL GROOVE)		01-86	12-87	3044	K	25	22	50		M			
C18	G31B (INTERNAL GROOVE)		01-86	12-87	3044	K	25	22	50		M			
C51A, C61A, C11	4G13 1300 (INTERNAL GROOVE)		01-87		3044	K	25	22	50		M			
C52A, C62A	4G15 1500 (INTERNAL GROOVE)		01-87		3044	K	25	22	50		M			
C53, GTI 16V	4G61 1600		01-87	12-91	3219	K	25	30	50		M			
C63, C66	4G61 1600		01-87	12-93	3219	K	25	30	50		M			
C64A	4D65 1800 (INTERNAL GROOVE)		01-87		3044	K	25	22	50		M			
C72A	4G15 1500 (INTERNAL GROOVE)		01-88		3044	K	25	22	50		M			
C74A	4D65 1800 (INTERNAL GROOVE)		01-88		3044	K	25	22	50		M			
C82A	(INTERNAL GROOVE)		01-88		3044	K	25	22	50		M			
CA4A	4G92 1600		01-94		3416	K	25	30	54		I			
CB6A	6A10 1600		02-92		3416	K	25	30	54		I			
CB7A	4D65 1800 TURBO		08-91		3309	K	25	23	54		M			
CB8A	4D68		10-92		3310	K	25	23	54		M			
CD5A	4G93 1800 TURBO		08-91		3416	K	25	30	54		I			
E55A	4G63 2000		01-92		3328	K	25	24	54		M			
E55A ABS	4G63 2000		01-93		3329	K	25	24	54	43	M			
TURBO			01-87	12-88	3142	K	25	23	50		M			
CORDIA														
1600	(INTERNAL GROOVE)		01-83	12-87	3044	K	25	22	50		M			
1800 TURBO			01-83	12-87	3217	K	25	23	50		M			
A212A	G32B 1600 (INTERNAL GROOVE)		01-84	12-88	3044	K	25	22	50		M			
A212A (NO TURBO)	G32B 1600 (INTERNAL GROOVE)		01-82	12-84	3044	K	25	22	50		M			
A212A TURBO	G32B 1600		01-82	12-84	3142	K	25	23	50		M			
A213A TURBO	G62B 1800		01-83	12-85	3142	K	25	23	50		M			
A213A, A213G TURBO (SX)	G62B 1800		01-84	12-87	3124	K	25	25	50		M			
A213G TURBO (DX)	G62B 1800		01-84	12-85	3124	K	25	25	50		M			
A213G TURBO (SX)	G62B 1800		01-84	12-85	3142	K	25	23	50		M			
A213G TURBO (SX)	G62B 1800		01-84	12-87	3124	K	25	25	50		M			
SE, SX, A213A	G62B 1800 (INTERNAL GROOVE)		01-82	12-84	3044	K	25	22	50		M			
DANGUN														
E55A	4G63 2000		01-92		3328	K	25	24	54		M			
E55A ABS	4G63 2000		01-93		3329	K	25	24	54	43	M			
ECLIPSE														
1,7	Mod. E32A Eng. 4G37 63 kW (86 HP)		87	90	3458	K	25	22	54		M			
1,8 (A.T./M.T.)	Mod. E32A w/Carb. Eng. 4G37		03-88	08-90	3458	K	25	22	54		M			



CHASSIS ↑

→ CHASSIS



G L O N .

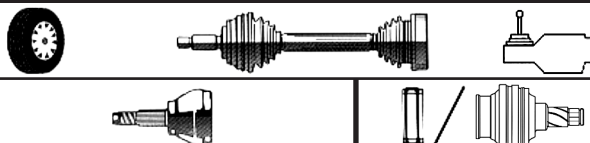

XXXX	K	A	B	C	ABS	P	XXXX	K	A	B	C
------	---	---	---	---	-----	---	------	---	---	---	---



MITSUBISHI

GALANT															
1.6	E11 (INTERNAL GROOVE)		01-84	12-87	3044	K	25	22	50		M				
1.7	Mod. E32A Eng. 4G37 63 kW (86 HP)		87	90	3458	K	25	22	54		M				
1.8	E14, E15		01-85	12-87	3142	K	25	23	50		M				
1.8 (A.T./M.T.)	Mod. E32A w/Carb. Eng. 4G37 66kW (90 HP)		03-88	08-90	3458	K	25	22	54		M				
2.0	E14, E15		01-85	12-87	3142	K	25	23	50		M				
2.0 TURBO (DX)	Mod. E15A Eng. G63B		84	86	3459	K	25	25	50		M				
2.4 TURBO VX (A.T./M.T.)			86		3459	K	25	25	50		M				
E11A (NO TURBO)	G32B 1600 (INTERNAL GROOVE)		01-83	12-87	3044	K	25	22	50		M				
E12A (NO TURBO)	G37B 1800 (INTERNAL GROOVE)		01-83	12-87	3044	K	25	22	50		M				
E13A (NO TURBO)	G62B 2000 (INTERNAL GROOVE)		01-83	12-87	3044	K	25	22	50		M				
E14A TURBO M.T.	4D65 1800		01-84	12-86	3142	K	25	23	50		M				
E15A (NO TURBO)	G63B 2000 (INTERNAL GROOVE)		01-83	12-87	3044	K	25	22	50		M				
E15A TURBO (DX)	G63B 2000		01-84	12-86	3124	K	25	25	50		M				
E15A TURBO (SX)	G63B 2000		01-84	12-86	3217	K	25	23	50		M				
E31A	4G32 1600 (INTERNAL GROOVE)		01-87		3044	K	25	22	50		M				
E32A	4G37 1800		01-87		3310	K	25	23	54		M				
E33A	4G63 2000		01-87		3309	K	25	23	54		M				
E35A	4G67 1.800		01-89		3309	K	25	23	54		M				
E55A	4G63 2000		01-92		3328	K	25	24	54		M				
E55A ABS	4G63 2000		01-93		3329	K	25	24	54	43	M				
SIGMA V6	100 LAC		90	93	3456	K	25	26	54		I				
GALANT ECLIPSE															
D22A	4G63 2000		01-89		3309	K	25	23	54		M				
D27A	4G63 2000		01-89		3309	K	25	23	54		M				
E11A	G32B 1600		01-84	12-86	3044	K	25	22	50		M				
E12A	G37B 1800		01-84	12-86	3044	K	25	22	50		M				
E13A	G62B 1800		01-84	12-86	3142	K	25	23	50		M				
E14A	4D65 TURBO		01-84	12-86	3142	K	25	23	50		M				
E15A	G62B 1800		01-87	12-88	3142	K	25	23	50		M				
E15A	G63B 2000		01-84	12-86	3124	K	25	25	50		M				
E16A	G64B 2400		01-85	12-88	3124	K	25	25	50		M				
E16A TURBO	G63B 2000		01-84	12-86	3124	K	25	25	50		M				
E27A 4WD	4G63 2000		01-88		3416	K	25	30	54		I				
E27A 4WD ABS			92		3435	K	25	30	54	43	I				
E31A	4G32 1600		01-87	12-93	3044	K	25	22	50		M				
E33A	4G63 2000		01-88		3309	K	25	23	54		M				
E34A	4D65 1800		01-88		3261	K	25	22	50		I				
E35A	4G67 1800		01-89		3309	K	25	23	54		M				
E37A	4G67 1800		01-88		3416	K	25	30	54		I				
E37A ABS			92		3435	K	25	30	54	43	I				
E39A	4G63 3000		01-88		3416	K	25	30	54		I				
E39A ABS			92		3435	K	25	30	54	43	I				
E55A	4G63 2000		01-92		3328	K	25	24	54		M				
E55A ABS	4G63 2000		01-93		3329	K	25	24	54	43	M				
E72A	4G93 1800		05-92		3416	K	25	30	54		I				



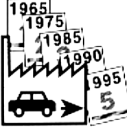

	CHASSIS →	→ CHASSIS		G L O N .											
				XXXX	K	A	B	C	ABS	P	XXXX	K	A	B	C
MITSUBISHI															
E72A ABS			92		3435	K	25	30	54	43	I				
E77A	4D68 2000		05-92		3416	K	25	30	54		I				
E77A ABS			92		3435	K	25	30	54	43	I				
E84A	6A12 2000		05-92		3416	K	25	30	54		I				
E84A ABS			92		3435	K	25	30	54	43	I				
GALANT SIGMA															
2.0			01-82	12-87	3217	K	25	23	50		M				
2.0 (NEW ZEALAND)	Mod. EA, EB Eng. E17A		86	89	3461	K	25	26	50		M				
3.0 (NEW ZEALAND)	Mod. EA, EB Eng. 6G72		88	92	3461	K	25	26	50		M				
3.0 V6 M.T.			01-85	12-87	3124	K	25	25	50		M				
V6 100 AC (USA)			88	89	3461	K	25	26	50		M				
LANCER															
TT	(NO INTERNAL GROOVE)		01-79	12-86	3261	K	25	22	50		I				
TT SUPER LANCER					3460	K	25	23	54		I				
LANCER-F															
1200 EL, GL	A15 (INTERNAL GROOVE)		01-83	12-88	3044	K	25	22	50		M				
1400	A15 (INTERNAL GROOVE)		01-83	12-88	3044	K	25	22	50		M				
1400 TURBO					3217	K	25	23	50		M				
1500 DIESEL	C12, C14 (INTERNAL GROOVE)		01-84	12-88	3044	K	25	22	50		M				
LANCER-F STATION WAGON															
1500 GL, GLX	(INTERNAL GROOVE)				3044	K	25	22	50		M				
1800	(INTERNAL GROOVE)				3044	K	25	22	50		M				
1800 DIESEL	12, C14 (INTERNAL GROOVE)				3044	K	25	22	50		M				
MAGNA (AUSTRALIA)															
2,6	Mod. TM-TN-TP Eng. 4G54B		01-85	12-90	3124	K	25	25	50		M				
2,6	Mod. TR Eng. 4G54B		90	93	3456	K	25	26	54		I				
MINICA, MINICA TOPPO															
H21V, A (SX)	Eng. 3G81		90	93	3452	K	27	18	43		M				
H22V, A M.T. (DX)	Eng. 3G83		90	93	3452	K	27	18	43		M				
H22V, A M.T. (DX/SX)	Eng. 3G83		90	93	3452	K	27	18	43		M				
H26V, A	Eng. 660		90	93	3452	K	27	18	43		M				
H27V, A A.T.			90	93	3452	K	27	18	43		M				
H27V, A A.T.	Eng. 660		90	93	3452	K	27	18	43		M				
H31A M.T. (DX)	Eng. 4A30		93		3452	K	27	18	43		M				
H32V, A (SX)	Eng. 660		93		3452	K	27	18	43		M				
H36A A.T.	Eng. 3G83		93		3452	K	27	18	43		M				
H37V			93		3452	K	27	18	43		M				
MIRAGE															
1.5 (USA)			93	95	3458	K	25	22	54		M				
TT (NO TURBO)	(NO INTERNAL GROOVE)		01-79	12-92	3261	K	25	22	50		I				
E55A	4G63 2000		01-92		3328	K	25	24	54		M				
E55A ABS	4G63 2000		01-93		3329	K	25	24	54	43	M				
NIMBUS (AUSTRALIA)															
1,8	Mod. UA-UB Eng. 4G37		01-84	08-87	3142	K	25	23	50		M				
2.0	Mod. UC Eng. 4g64		09-87	12-91	3142	K	25	23	50		M				



	CHASSIS ↑	→ CHASSIS		G L O N .										
														
				XXXX	K	A	B	C	ABS	P	XXXX	K	A	B
MITSUBISHI														
NIMBUS														
2.0 Mod. UC Eng. 4G64 (NO INTERNAL GROOVE)			09-87	12-91	3261	K	25	22	50		I			
PRECIS														
82 AC/LAC (INTERNAL GROOVE)			01-87	12-93	3044	K	25	22	50		M			
SIGMA														
3.0 100 LAC Mod. F13 Eng. 6G73			90	93	3456	K	25	26	54		I			
SPACE WAGON														
2.0 GLX 87			01-84		3142	K	25	23	50		M			
SUPER SALON														
GCX 2.0					3310	K	25	23	54		M			
TREDIA														
1400 (INTERNAL GROOVE)			01-83	12-87	3044	K	25	22	50		M			
1600 (INTERNAL GROOVE)			01-83	12-87	3044	K	25	22	50		M			
1600 TURBO			01-84	12-87	3217	K	25	23	50		M			
A211A G12B 1400 (INTERNAL GROOVE)			01-82	12-84	3044	K	25	22	50		M			
A212A.A.T. G32B 1600 (INTERNAL GROOVE)			01-82	12-84	3044	K	25	22	50		M			
A212A TURBO G32B 1600			01-82	12-84	3142	K	25	23	50		M			
A213A G37B 1800 (INTERNAL GROOVE)			01-84	12-87	3044	K	25	22	50		M			
A213A TURBO G62B 1800			01-83	12-84	3142	K	25	23	50		M			
A213A TURBO (DX) G62B 1800			01-84	12-85	3124	K	25	25	50		M			
A213A TURBO (SX) G62B 1800			01-84	12-85	3142	K	25	23	50		M			
A215A.A.T. G62B 1800 (INTERNAL GROOVE)			01-82	12-84	3044	K	25	22	50		M			
A215G M.T. (SX) G37B 1800			01-84	12-87	3124	K	25	25	50		M			
TT G32B 1600 (INTERNAL GROOVE)			01-84	12-88	3044	K	25	22	50		M			
VISTA														
TT			01-84	12-86	3124	K	25	25	50		M			
MOSKVICH														
ALEKO														
2141					3226	K	25	25	53		E	4512	K	25 100

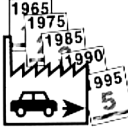

	CHASSIS →	→ CHASSIS		G L O N .										
														
				XXXX	K	A	B	C	ABS	P	XXXX	K	A	B
NISSAN-DATSUN														
ALMERA (IRELAND)														
2.0 DIESEL			96		3143	K	25	23	52		I			
AUSTER, STANZA														
PT12 A.T. CA18I 1800			01-85	12-88	3233	K	27	25	56		I			
PT12 M.T. CA18I 1800			01-85	12-88	3098	K	27	23	56		I			
PT12 TURBO CA18ET/DET 1800			01-85	12-88	3233	K	27	25	56		I			
T12 CA16S 1600			01-85	12-88	3098	K	27	23	56		I			
BLUEBIRD														
RU12 CA18I 1800			01-87	12-89	3147	K	27	23	56		I			
RU12 SR18DI 1800			01-89		3147	K	27	23	56		I			
U11, RU11 CA16S 1600			01-83	12-87	3098	K	27	23	56		I			
VEU11 M.T. LD20 2000			01-87		3147	K	27	23	56		I			
VEU11, U11, WU11 TURBO CA18DET 1800			01-83	12-87	3233	K	27	25	56		I			
VEU11, U11, WU11 TURBO CA20/LD20 2000			01-83	12-87	3233	K	27	25	56		I			
VRU11 CA18E/S 1800			01-83	12-87	3098	K	27	23	56		I			
YU11, EU11 C118I/18ET 1800			01-83	12-87	3233	K	27	25	56		I			
BLUEBIRD MAXIMA														
PU11 VG20E/ET 2000			01-85	12-88	3233	K	27	25	56		I			
U11 1600			01-84	12-86	3098	K	27	23	56		I			
U11 A.T. CA18S 1800			01-85	12-88	3233	K	27	25	56		I			
U11 M.T. CA18S 1800			01-85	12-88	3098	K	27	23	56		I			
WU11 A.T. CA18E 1800			01-85	12-88	3233	K	27	25	56		I			
WU11 M.T. CA18S 1800			01-85	12-88	3098	K	27	23	56		I			
CEFIRO														
2000			01-92	12-97	3378	K	29	25	56		I			
2000 ABS			01-94		3408	K	29	25	56	46	I			
CEFIRO (TAIWAN)														
3.0 ABS					3507	K	32	34	62	50	I			
CHERRY														
1,5 Mod. N12 Eng. E15S			01-83	12-86	3686	K	24	22	52		I			
N10 1.2, 1.4, 1.5			02-79	07-84	3045	K	24	22	52		M			
N12 1.5, 1.6			08-82	12-86	3686	K	24	22	52		I			
N12 1.3 Eng. E13 (60 HP)			08-84	12-86	3111	K	21	22	48		I			
N12 DIESEL 1700 D			08-82	12-86	3686	K	24	22	52		I			
DATSUN 140														
1.4Y TRAVELLER HLB 310 M.T. 49 kW (67 HP)			02-79	06-83	3045	K	24	22	52		M			
E10														
TT			01-71	01-75	3045	K	24	22	52		M			
F10														
TT			02-75	12-82	3045	K	24	22	52		M			
FEELING														
TT					3147	K	27	23	56		I			
HF (MEXICO)														
(A.T./M.T.)			96		3451	K	25	32	55		I			
LANGLEY														
1.3 M.T. Mod. B11/N12 Eng. E13S			05-82	07-86	3111	K	21	22	48		I			



CHASSIS →

→ CHASSIS



G L O N .

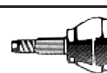

XXXX	K	A	B	C	ABS	P	XXXX	K	A	B	C
------	---	---	---	---	-----	---	------	---	---	---	---

NISSAN-DATSUN

1.4 WDA.T./M.T. Front Mod. EB13/EB14 Eng. GA14DE/GA14DS			10-90		3268	K	25	23	55		I								
1.5 4WD A.T./M.T. Front Mod. B13/N14 Eng. GA15DS			01-91		3268	K	25	23	55		I								
1.6 A.T./M.T. Mod. B11			08-82	12-86	3686	K	24	22	52		I								
1.6 M.T. Mod. B12/N13 Eng. E16S			08-86	12-90	3143	K	25	23	52		I								
1.7 DIESEL 4WD M.T. Front Mod. B13/N14 Eng. CD17			01-91		3268	K	25	23	55		I								
1.7 DIESEL A.T./M.T. Mod. B11/N12 Eng. CD17			04-82	07-86	3686	K	24	22	52		I								
1.7 DIESEL M.T. Mod. B13/N14 Eng. CD17			01-91		3271	K	25	22	55		I								
1.8 4WD M.T. Front Mod. B13/N14 Eng. GA18DE			01-91		3268	K	25	23	55		I								
1.8 A.T./M.T. Mod. EN13 Eng. CA18D			01-89	06-91	3384	K	25	25	52,3		I								
2.0 DIESEL A.T./M.T. Mod. B13/N14 Eng. CD20			01-91		3271	K	25	22	55		I								
2.0 M.T. Mod. B13/N14 Eng. SR20			01-91		3268	K	25	23	55		I								
LANGLEY, PULSAR, SENTRA, SUNNY																			
130A					3209	K	21	19	48		M								
B12, RB12 E13S 1300			01-86	12-90	3110	K	25	22	52,2		I								
B13-N14-FB13-FN14 (2WD) GA13DIESEL 1.3 - GA15DIESEL 1.5			01-90		3271	K	25	22	55		I								
B13-N14-FB13-FN14 (2WD) ABS GA13DIESEL 1.3 - GA15DIESEL 1.5			01-90		3426	K	25	22	55	42	I								
EB13-EN14 (2WD) GA16DE 1600			01-90		3268	K	25	23	55		I								
EB13-EN14 ABS (2WD) GA16DE 1600			01-90		3269	K	25	23	55	42	I								
EN 13 CA 16 DE 1600			01-86	12-90	3384	K	25	25	52,3		I								
HB13-HN14 (2WD) SA18DE 1800, 2000			01-90		3270	K	25	25	55		I								
HB13-HN14 ABS (2WD) SA18DE 1800, 2000			01-90		3314	K	25	25	55	42	I								
JN13 E15S 1500			01-86	12-90	3110	K	25	22	52,2		I								
JN13, HN13 E15S 1500			01-86	12-90	3110	K	25	22	52,2		I								
SB12 M.T. CD17 1700			01-85	12-90	3110	K	25	22	52,2		I								
SN13 M.T.			01-85	12-90	3110	K	25	22	52,2		I								
LUCINO HF S A.T. (MEXICO)																			
			01-96	12-98	3451	K	25	32	55		I								
MARCH K10																			
TT			01-83	12-87	3149	K	21	19	48		I								
MARCH																			
1.0 Mod. K10 Eng. MA10 A/T+M/T			01-82	12-90	3149	K	21	19	48		I								
1.0 Mod. LE10 Eng. MA10			06-89	12-92	3150	K	23	19	48		I								
1.2 Mod. LE10 Eng. MA12			06-89	12-92	3150	K	23	19	48		I								
1.3 K11 CG13DE			01-93		3380	K	23	22	48		I								
MAXIMA																			
3.0i 125 kW (170 HP) Eng. VG30E			10-88	06-94	3377	K	27	25	56		I								
MICRA																			
1.0			01-93		3392	K	23	19	48		I								
1.0 A.T./M.T. Mod. K10 43 kW (59 HP)			12-82	05-91	3149	K	21	19	48		I								
1.0 A.T./M.T. Mod. K10 Eng. MA10S 37/40 kW (50-54 HP)			12-82	12-89	3149	K	21	19	48		I								
1.0 ABS			01-93		3393	K	23	19	48	42	I								
1.2 M.T. Mod. K10 Eng. MA12S 40/44 kW (54-60 HP)			07-86	07-92	3149	K	21	19	48		I								
1,3			01-93		3391	K	23	22	48		I								
1.3 ABS			01-93		3385	K	23	22	48	42	I								
1.3i 16V A.T./M.T. Mod. K11 Eng. CG13DE 55 kW (75 HP)			08-92		3380	K	23	22	48		I								



	CHASSIS →	→ CHASSIS		G L O N .										
				XXXX	K	A	B	C	ABS	P	XXXX	K	A	B
NISSAN-DATSUN														
N10														
TT			01-79	12-81	3209	K	21	19	48			M		
NEW SENTRA														
B13	1400		01-89	12-97	3379	K	25	30	55			I		
B13	1600		01-89	12-97	3379	K	25	30	55			I		
PRAIRIE														
1.5 Mod. M10-BM10	Eng. E15S		09-83	03-85	3686	K	24	22	52			I		
PRESEA														
HR10	SR20DE 2.0		01-90		3270	K	25	25	55			I		
HR10 ABS	SR20DE 2.0		01-90		3314	K	25	25	55	42		I		
PR10 ABS, LSD	SR18DE 1.8		01-90		3314	K	25	25	55	42		I		
PR10 LSD	SR18DE 1.8		01-90		3270	K	25	25	55			I		
R10 MT&AT	GA15DIESEL 1.5		01-90		3271	K	25	22	55			I		
R10 MT&AT ABS	GA15DIESEL 1.5		01-90		3426	K	25	22	55	42		I		
PRIMERA														
1600 BZ, 2000 DIESEL			01-90	03-91	3147	K	27	23	56			I		
1600 BZ, 2000 DIESEL			03-91	12-96	3146	K	27	22	56			I		
1600 BZ, 2000 DIESEL (ABS)			01-90	03-91	3423	K	27	23	56	42		I		
1600 BZ, 2000 DIESEL (ABS)			03-91	12-96	3422	K	27	22	56	42		I		
2000			01-89	12-97	3377	K	27	25	56			I		
2000 GT			05-90		3148	K	27	32	56			I		
2000 GT ABS			05-90		3424	K	27	32	56	42		I		
PULSAR														
1.3 M.T.	Mod. B12/N13 Eng. E13S		08-86	12-90	3110	K	25	22	52,2			I		
1.5 A.T./M.T.	Mod. B12/N13 Eng. E15E/E15T		08-86	12-90	3384	K	25	25	52,3			I		
1.6 A.T.	Mod. B12/N13 Eng. E16S		08-86	12-90	3110	K	25	22	52,2			I		
1.7 DIESEL M.T.	Mod. B12/N13 Eng. CD17		08-86	12-90	3110	K	25	22	52,2			I		
1.8 A.T./M.T.	Mod. EN13 Eng. CA18D		01-89	06-91	3384	K	25	25	52,3			I		
PULSAR, LANGLEY, LIBERTAVILLA														
MN10, KMN10	E15 1500		01-81	12-82	3045	K	24	22	52			M		
VMN10			01-81	12-82	3045	K	24	22	52			M		
PULSAR, LANGLEY, LIBERTAVILLA, SUNNY														
B11	E13S 1300		01-82	12-86	3111	K	21	22	48			I		
EN 13	CA 16 DE 1600		01-86	12-90	3384	K	25	25	52,3			I		
HN12, HB11	E15S 1500		01-81	12-86	3686	K	24	22	52			I		
KHB11	E15S 1500		01-81	12-86	3686	K	24	22	52			I		
PHB11	E15S 1500		01-81	12-86	3686	K	24	22	52			I		
PN12	E13S 1300		01-82	12-86	3111	K	21	22	48			I		
VB11	E13S 1300		01-82	12-86	3111	K	21	22	48			I		
VHB11	E15S 1500		01-81	12-86	3686	K	24	22	52			I		
WHB11	E15S 1500		01-81	12-86	3686	K	24	22	52			I		
PULSAR, LANGLEY, LAURELSPRIT, LIBERTAVILLA, SENTRA, SUNNY														
EN 13	CA 16 DE 1600		01-86	12-90	3384	K	25	25	52,3			I		
SN12, SB11	CD17 1700		01-82	12-85	3686	K	24	22	52			I		
VSB11			01-82	12-85	3686	K	24	22	52			I		
WSB11			01-82	12-85	3686	K	24	22	52			I		



CHASSIS ↑

→ CHASSIS

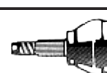

**G L O N .**

XXXX K A B C ABS P XXXX K A B C

NISSAN-DATSUN

Model		Start	End	Code	K	A	B	C	ABS	P	Code	K	A	B	C
PULSAR Q (AUSTRALIA)															
1,6	Mod. N13 Q Series Eng. A16/R18 GMH	07-87	11-91	3384	K	25	25	52,3		I					
1,8	Mod. N13 Q Series Eng. A16/R18 GMH	07-87	11-91	3384	K	25	25	52,3		I					
PULSAR, SENTRA															
B12, N13		01-87	12-89	3143	K	25	23	52		I					
EN 13	CA 16 DE 1600	01-86	12-90	3384	K	25	25	52,3		I					
PULSAR, SENTRA, SUNNY 4WD															
FNB13-FNN14-HNB13, ABS GA15DIESEL 1.5 - SR18DE 1.8		01-90		3269	K	25	23	55	42	I					
FNB13-FNN14-SNB13-HNB13 GA15DIESEL 1.5 - CD17 1.7 - SR18DE 1.8		01-90		3268	K	25	23	55		I					
RNN14 SR20DET 2.0		01-90		3270	K	25	25	55		I					
RNN14 ABS SR20DET 2.0		01-90		3314	K	25	25	55	42	I					
PULSAR, SENTRA, SUNNY															
WSB12 M.T.		01-85	12-90	3110	K	25	22	52,2		I					
SENTRA HF A.T. (MEXICO)															
		01-96	12-98	3451	K	25	32	55		I					
SENTRA (SOUTH AFRICA)															
140-140CX		01-93		3271	K	25	22	55		I					
140-140CX ABS		01-93		3426	K	25	22	55	42	I					
160-160CX-160CS-160SE		01-93		3268	K	25	23	55		I					
160-160CX-160CS-160SE, ABS		01-93		3269	K	25	23	55	42	I					
SENTRA (USA)															
1.6 Mod. B14 ABS		95	97	3469	K	25	32	55		I					
SKYLINE (LONGITUDINAL SHAFT)															
R31	6 CYL TT	06-86	06-88	4060			24	94							
R31	8 CYL 3.0L	06-88	12-91	4060			24	94							
STANZA															
1.6 Mod. CA12		01-81	12-86	3686	K	24	22	52		I					
1.6 Mod. T12		01-85	12-88	3098	K	27	23	56		I					
1.8 Mod. CA18		01-81	12-86	3686	K	24	22	52		I					
1.8 Turbo M.T.	Mod. PT12 Eng. CA18TE	01-85	12-88	3233	K	27	25	56		I					
TSURU I															
(M.T.)		01-84	12-87	3108	K	24	22	52		E					
(A.T.)		01-84	12-87	3108	K	24	22	52		E					
TSURU II															
(M.T.)		01-88	12-92	3367	K	25	24	52,2		I					
(A.T.)		01-88	12-92	3367	K	25	24	52,2		I					
B12 (Mexico)		88	92	3489	K	25	22	55		I					
TSURU GS															
(M.T.)		01-92	12-95	3368	K	25	24	55		I					
(A.T.)		01-92	12-95	3368	K	25	24	55		I					
TSUBAME															
(M.T.)		01-93	12-95	3368	K	25	24	55		I					
(A.T.)		01-93	12-95	3368	K	25	24	55		I					
VECTOR (AUSTRALIA)															
1.5 Mod. N12	Eng. E15	08-82	06-88	3686	K	24	22	52		I					

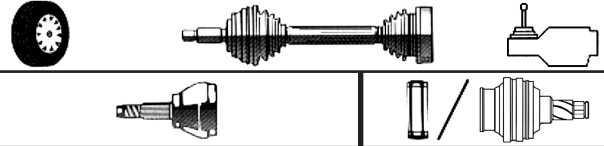

	CHASSIS →	→ CHASSIS		G L O N .											
															
				XXXX	K	A	B	C	ABS	P	XXXX	K	A	B	C

NISSAN-DATSUN

100 NX (A/T - M/T)															
1,6	Eng. GA16DS 66 kW (90 HP)		03-90		3268	K	25	23	55		I				
2.0 GTI	Eng. SR20DE 105 kW (143 HP)		03-91		3268	K	25	23	55		I				
120A - 810															
TT			01-75	12-81	3209	K	21	19	48		M				
310															
TT			02-75	12-83	3045	K	24	22	52		M				

OLDSMOBILE (GENERAL MOTORS)

ACHIEVA															
TT ABS			01-91	12-92	3155	K	33	32	63	48	E				
CALAIS															
2,8			01-90	12-91	3132		33	32	73		E				
TT, A.T.			01-85	12-90	3017	K	33	29	47,7		E				
TT, A.T. NO ABS			01-91	12-91	3017	K	33	29	47,7		E				
CIERA (COUPE - SEDAN - WAGON)															
2.2, 3 SPEED, A.T.			01-93	12-93	3130		27	29	61,5		E				
2.5, 3 SPEED, A.T.			01-90	12-92	3130		27	29	61,5		E				
3 SPEED, A.T. 20 MM DIA SPINDLE THREAD			01-84	12-84	3017	K	33	29	47,7		E				
3 SPEED, A.T. 24 MM DIA SPINDLE THREAD			01-84	12-84	3026	K	27	32	61,5		E				
4 CYL, 3 SPEED 24 MM DIA SPINDLE THREAD			01-89	12-89	3130		27	29	61,5		E				
4 SPEED, A.T. 20 MM DIA SPINDLE THREAD			01-84	12-84	3017	K	33	29	47,7		E				
4 SPEED, A.T. 24 MM DIA SPINDLE THREAD			01-84	12-84	3026	K	27	32	61,5		E				
TT 20 MM DIA SPINDLE THREAD			01-82	12-83	3017	K	33	29	47,7		E				
TT 24 MM DIA SPINDLE THREAD			01-83	12-83	3026	K	27	32	61,5		E				
TT, M.T. 20 MM DIA SPINDLE THREAD			01-84	12-84	3017	K	33	29	47,7		E				
TT, M.T. 24 MM DIA SPINDLE THREAD			01-84	12-84	3026	K	27	32	61,5		E				
CUTLASS SUPREME															
3.1, 3 SPEED, A.T.			01-91	12-93	3131		33	29	73		E				
3.1, 4 SPEED, A.T., ABS			01-91	12-91	3133		33	32	73	47	E				
3.1, 4 SPEED, A.T., NO ABS			01-92	12-92	3132		33	32	73		E				
3.4, 5 SPEED, M.T., ABS			01-91	12-91	3133		33	32	73	47	E				
3.4, 5 SPEED, M.T., NO ABS			01-92	12-92	3132		33	32	73		E				
3.4, A.T., NO ABS			01-92	12-92	3132		33	32	73		E				
TT ABS			01-89	12-90	3133		33	32	73	47	E				
TT, NO ABS			01-88	12-90	3132		33	32	73		E				



CHASSIS ↑

→ CHASSIS

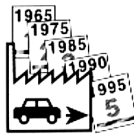

G L O N .



XXXX K A B C ABS P XXXX K A B C



OLDSMOBILE (GENERAL MOTORS)

TT, 3 SPEED, A.T., ABS			01-90	12-91	3133		33	32	73	47	E						
TT, 3 SPEED, A.T., NO ABS			01-90	12-91	3132		33	32	73		E						
V6 TWIN DUAL CAM, A.T. ABS			01-91	12-91	3133		33	32	73	47	E						
V6 TWIN DUAL CAM, A.T. NO ABS			01-91	12-91	3132		33	32	73		E						
FIRENZA																	
TT			01-82	12-88	3017	K	33	29	47,7		E						
NINETY-EIGHT																	
TT	DESIGN I		01-85	12-85	3026	K	27	32	61,5		E						
OMEGA																	
TT			01-80	12-84	3017	K	33	29	47,7		E						
TORONADO																	
TT		3Z57R9E107245	01-79	12-84	3018		27	34	55,9		E						
TT			3Z57R9E107244	12-79	3037	K	27	34	55,9		M						
TT ABS			01-89	12-91	3135		33	32	61,5	47	E						
TT NO ABS			01-89	12-90	3134		33	32	61,5		E						

OPEL (EUROPE)

ASCONA																	
1.3	50/55 kW (68-75 HP)	C000001	J999999	08-81	10-88	3039	K	22	22	52		E	4039	K	22	22	84
1.6	55 kW (75 HP)	C000001	J999999	08-81	10-88	3039	K	22	22	52		E	4039	K	22	22	84
1.6 DIESEL	40 kW (54 HP)	C000001	J999999	08-81	10-88	3538	K	33	25	52		E	4038	K	34	22	84
1.6 S	66 kW (90 HP)	C000001	J999999	08-81	10-88	3538	K	33	25	52		E	4038	K	34	22	84
1.8	85 kW (115 HP)	D000001	J999999	08-82	10-88	3538	K	33	25	52		E					
2.0	73/85/95 kW (100-115-130 HP)	D000001	J999999	08-82	10-88	3538	K	33	25	52		E					
ASTRA (A.T.)																	
1.6				01-93		3402	K	22	30	52		I					
1.6 ABS	55 kW (75 HP)	N-4000 01	N-4026608	08-91	12-92	3126	K	22	22	52	29	E					
1.6 ABS				01-93		3403	K	22	30	52	29	I					
1.7 DIESEL ABS	42 kW (57 HP)	N-4000 01	N-4026608	08-91	12-92	3100	K	33	25	52	29	E					
1.7 TURBO DIESEL ABS	60 kW (82 HP)	N-4000 01		08-91		3100	K	33	25	52	29	E					
1.8 ABS	66 kW (90 HP)	N-4000 01		08-91		3100	K	33	25	52	29	E					
2.0 ABS	85 kW (115 HP)	N-4000 01		08-91		3100	K	33	25	52	29	E					
ASTRA (M.T.)																	
1.4 ABS	44/60 kW (60-82 HP)	N-4000001	N-4029608	08-91	12-92	3126	K	22	22	52	29	E	4039	K	22	22	84
1.4 ABS	44/60 kW (60-82 HP)			01-94		3360	K	22	22	52	29	E					
1.6 ABS	55/74 kW (75-100 HP)	N-4000001	N-4029608	08-91	12-92	3126	K	22	22	52	29	E	4039	K	22	22	84
1.6 ABS	55/74 kW (75-100 HP)			01-94		3360	K	22	22	52	29	E					

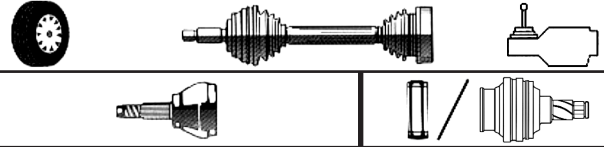

		CHASSIS →	→ CHASSIS			G L O N . 											
						XXXX	K	A	B	C	ABS	P	XXXX	K	A	B	C
OPEL (EUROPE)																	
1.7 DIESEL ABS	42 kW (57 HP)	N-4000001		08-91	12-92	3100	K	33	25	52	29	E	4039	K	22	22	84
1.7 DIESEL ABS	42 kW (57 HP)			01-94		3360	K	22	22	52	29	E					
1.7 TURBO DIESEL ABS	60 kW (82 HP)	N-4000001		08-91		3100	K	33	25	52	29	E					
1.8 ABS	66 kW (90 HP)	N-4000001		08-91		3100	K	33	25	52	29	E					
2.0 ABS	85/110 kW (115-150 HP)	N-4000001		08-91		3100	K	33	25	52	29	E					
2.0 GSi 16V ABS		N-4000001		08-91		3100	K	33	25	52	29	E					
ASTRA G																	
1.2 16V	Eng. X12XE 48 kW (65 HP)			09-98		3480	K	33	28	52		E					
1.4 16V	Eng. X14XE 66 kW (90 HP)			09-98		3476	K	33	22	52		E					
1.6 16V	Eng. X16XEL 74 kW (101 HP)			09-98		3476	K	33	22	52		E					
1.7 TURBO DIESEL	Eng. X17DTL 60 kW (82 HP)			09-98		3476	K	33	22	52		E					
1.8 16V	Eng. X18XE1 85 kW (115 HP)			09-98		3478	K	33	25	52		E					
2.0 16V	Eng. X20XEV 100 kW (136 HP)			09-98		3478	K	33	25	52		E					
2.0 Di	Eng. X20DTL 60 kW (82 HP)			09-98		3478	K	33	25	52		E					
CALIBRA (A.T.)																	
2.0i ABS	85 kW (115 HP)	N50000001		08-91		3100	K	33	25	52	29	E					
2.0i ABS	85 kW (115 HP)		N50000000	08-91	07-91	3127	K	33	25	52	43	E					
CALIBRA (M.T.)																	
2.0i 16V ABS	110 kW (150 HP)		N50000000	08-91	07-91	3127	K	33	25	52	43	E					
2.0i 16V ABS	110 kW (150 HP)	N50000001		08-91		3100	K	33	25	52	29	E					
2.0i ABS	85 kW (115 HP)		N50000000	08-91	07-91	3127	K	33	25	52	43	E					
2.0i ABS	85 kW (115 HP)	N50000001		08-91		3100	K	33	25	52	29	E					
CALIBRA 4WD (M.T.)																	
2.0 TURBO ABS	150 kW (205 HP)	N-10000 01		08-91		3100	K	33	25	52	29	E					
2.0i ABS	85 kW (115 HP)	L-10000 01	M-19999 99	08-91	07-91	3127	K	33	25	52	43	E					
2.0i ABS	85 kW (115 HP)	N-10000 01		08-91		3100	K	33	25	52	29	E					
COMBO																	
1.2 ABS M.T.	33 kW (45 HP)			07-94		3359	K	22	28	52	29	E					
1.4 ABS M.T.	44/60 kW (60-82 HP)			07-94		3359	K	22	28	52	29	E					
1.7 DIESEL ABS M.T.	44 kW (60 HP)			07-94		3359	K	22	28	52	29	E					
CORSA A																	
1.0	33 kW (45 HP)			09-82	12-93	3068	K	22	28	51,8		E					
1,2	33/40 kW (45-55 HP)			09-82	12-93	3068	K	22	28	51,8		E					
1,3	51 kW (70 HP)			09-82	12-93	3068	K	22	28	51,8		E					
1,4	44/60 kW (60-82 HP)			01-90	12-93	3068	K	22	28	51,8		E					
1.5 DIESEL	37 kW (50 HP)			09-87	12-93	3068	K	22	28	51,8		E					
1.5 TURBO DIESEL	49 kW (67 HP)			09-87	12-93	3039	K	22	22	52		E	4039	K	22	22	84
1,6	72/74 kW (98-101 HP)			07-87	12-93	3039	K	22	22	52		E	4039	K	22	22	84
CORSA B																	
1.2 ABS	33/40 kW (45-55 HP)			01-94		3359	K	22	28	52	29	E					
1.4 ABS	44/66 kW (60-90 HP)			01-94		3359	K	22	28	52	29	E					
1.6 ABS	72/74 kW(98-101 HP)			01-94		3360	K	22	22	52	29	E					
KADETT D																	
1.0	29/37 kW (40-50 HP)		C-000090	08-79	12-81								4039	K	22	22	84
1.0	29/37 kW (40-50 HP)	C000091	D999999	01-81	07-84	3039	K	22	22	52		E	4039	K	22	22	84
1,2	39/44 kW (53-60 HP)		C-000090	08-79	12-81								4039	K	22	22	84



CHASSIS ↑

→ CHASSIS

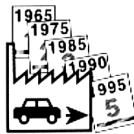

G L O N .

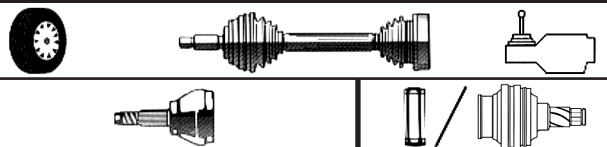







XXXX	K	A	B	C	ABS	P	XXXX	K	A	B	C
------	---	---	---	---	-----	---	------	---	---	---	---

OPEL (EUROPE)

1,2	39/44 kW (53-60 HP)	C000091	D999999	01-81	07-84	3039	K	22	22	52		E	4039	K	22	22	84
1,3	55 kW (75 HP)		C-000090	08-79	12-81								4039	K	22	22	84
1,3	55 kW (75 HP)	C000091	D999999	01-81	07-84	3039	K	22	22	52		E	4039	K	22	22	84
1,6	55 kW (75 HP)	C000091	D999999	01-81	07-84	3039	K	22	22	52		E	4039	K	22	22	84
1.6S	66 kW (90 HP)	C000001	D999999	01-81	07-84	3538	K	33	25	52		E					
1.6 DIESEL	39 kW (54 HP)	C000001	D999999	08-81	07-84	3538	K	33	25	52		E					
1.8E & DIESEL	84 kW (115 HP)	C000001	D999999	01-81	07-84	3538	K	33	25	52		E					
KADETT E (M.T.)																	
1,2	40 kW (55 HP)	F0000001	J865387	09-84	12-91	3039	K	22	22	52		E	4039	K	22	22	84
1.2 ABS	40 kW (55 HP)	F0000001	J865387	09-84	12-91	3126	K	22	22	52	29	E	4039	K	22	22	84
1,3	44/55 kW (60-75 HP)	F0000001	J865387	09-84	12-91	3039	K	22	22	52		E	4039	K	22	22	84
1.3 ABS	44/55 kW (60-75 HP)	F0000001	J865387	09-84	12-91	3126	K	22	22	52	29	E	4039	K	22	22	84
1,4	40/53 kW (55-72 HP)			01-90	12-91	3039	K	22	22	52		E	4039	K	22	22	84
1.4 ABS	40/53 kW (55-72 HP)			01-90	12-91	3126	K	22	22	52	29	E	4039	K	22	22	84
1,6	55 kW (75 HP)	F0000001	J865387	09-84	12-91	3039	K	22	22	52		E	4039	K	22	22	84
1.6 ABS	55 kW (75 HP)	F0000001	J865387	09-84	12-91	3126	K	22	22	52	29	E	4039	K	22	22	84
1.6S	66 kW (90 HP)	F0000001		08-84	12-91	3538	K	33	25	52		E	4038	K	34	22	84
1,8	62/85 kW (85-115 HP)	F0000001		08-84	12-91	3538	K	33	25	52		E					
1.8 ABS	62/85 kW (85-115 HP)	F0000001		08-84	12-91	3100	K	33	25	52	29	E					
1.8 ABS	62/85 kW (85-115 HP)	F0000001		08-84	12-91	3127	K	33	25	52	43	E					
2,0	85 kW (115 HP)	F0000001		08-84	12-91	3538	K	33	25	52		E					
2.0 ABS	85 kW (115 HP)	F0000001		08-84	12-91	3100	K	33	25	52	29	E					
2.0 ABS	85 kW (115 HP)	F0000001		08-84	12-91	3127	K	33	25	52	43	E					
2.0 16V	110 kW (150 HP)	F0000001		08-84	12-91	3538	K	33	25	52		E					
2.0 16V ABS	110 kW (150 HP)	F0000001		08-84	12-91	3100	K	33	25	52	29	E					
2.0 16V ABS	110 kW (150 HP)	F0000001		08-84	12-91	3127	K	33	25	52	43	E					
KADETT E (A.T.)																	
1,3	44/55 kW (60-75 HP)	F0000001		08-84	12-91	3039	K	22	22	52		E					
1,6	55 kW (75 HP)	F0000001		08-84	12-91	3039	K	22	22	52		E					
1.6 ABS	55 kW (75 HP)	F0000001		08-84	12-91	3126	K	22	22	52	29	E					
KADETT E DIESEL (M.T.)																	
1.6 DIESEL	40 kW (54 HP) (F16)	F0000001		08-84	12-91	3538	K	33	25	52		E	4038	K	34	22	84
1.6 DIESEL	40 kW (54 HP) (F13)	F0000001		08-84	12-91	3538	K	33	25	52		E	4039	K	22	22	84
1.6 DIESEL ABS	40 kW (54 HP) (F16)	F0000001		08-84	12-91	3100	K	33	25	52	29	E	4038	K	34	22	84
1.6 DIESEL ABS	40 kW (54 HP) (F13)	F0000001		08-84	12-91	3100	K	33	25	52	29	E	4039	K	22	22	84
1.7 DIESEL	42 kW (57 HP)	F0000001		01-89	12-91	3538	K	33	25	52		E					
1.7 DIESEL ABS	42 kW (57 HP)	F0000001		01-89	12-91	3100	K	33	25	52	29	E					
1.7 DIESEL ABS	42 kW (57 HP)			02-89	8-91	3127	K	33	25	52	43	E					
OMEGA A (A.T./M.T.)																	
2,0, i SW (ABS or NO ABS)	74/85/90 kW (101-115-122 HP)			08-86	03-94	4501	K		28	108							
2,3 TD, SW (ABS or NO ABS)	66/74 kW (90-101 HP)			08-86	03-94	4501	K		28	108							
2,4, SW (ABS or NO ABS)	92 kW (125 HP)			08-86	03-94	4501	K		28	108							
2,6i (ABS or NO ABS)	110 kW (149 HP)			09-90	03-94	4501	K		28	108							
3,0, 24V, SW (ABS or NO ABS)	115/130/147/150 kW (156-177-200-204 HP)			08-86	03-94	4501	K		28	108							
OMEGA																	
2,0 SW (A.T. - M.T.)	74/90 kW (101-123 HP)			08-86	03-94	4052	K		33	100							



	CHASSIS →	→ CHASSIS		G L O N .											
															
															
				XXXX	K	A	B	C	ABS	P	XXXX	K	A	B	C

OPEL (EUROPE)

2.3 TURBO DIESEL (A.T. - M.T.)	74 kW (101 HP)			08-86	03-94	4052	K		33	100							
2.3 TURBO DIESEL SW (A.T. - M.T.)	74 kW (101 HP)			08-86	03-94	4052	K		33	100							
2.4 - 2.4 SW (A.T. - M.T.)	92 kW (125 HP)			08-86	03-94	4052	K		33	100							
2.6 (A.T. - M.T.)	110 kW (150 HP)			08-86	03-94	4052	K		33	100							
3.0 - 3.0 SW (A.T. - M.T.)	130/150 kW (177-204 HP)			08-86	03-94	4052	K		33	100							
SENATOR A (A.T./M.T.)																	
3.0 (ABS or NO ABS)	115 kW (156 HP)			09-85	87	4501	K		28	108							
SENATOR B (A.T./M.T.)																	
3.0, 24V (ABS or NO ABS)	115/130/150 kW (156-177-204 HP)			87	93	4501	K		28	108							
SENATOR																	
2.5 (A.T. - M.T.)	103 kW (140 HP)			09-87	06-93	4052	K		33	100							
3.0 (A.T. - M.T.)	114/130 kW (156-177 HP)			09-87	06-93	4052	K		33	100							
TIGRA																	
1.4 16V (ABS or NO ABS) M.T.	66 kW (90 HP)			07-94		3359	K	22	28	52	29	E					
VECTRA (M.T.)																	
1.4 ABS	44/60 kW (60-82 HP)	K1000001	M1999999	10-88	07-91	3118	K	22	22	52	43	E	4039	K	22	22	84
1.4 ABS	44/60 kW (60-82 HP)	N1000001	P-11752 49	08-91	12-93	3126	K	22	22	52	29	E	4039	K	22	22	84
1.6 ABS	55/74 kW (75-110 HP)	K1000001	M1999999	10-88	07-91	3118	K	22	22	52	43	E	4039	K	22	22	84
1.6 ABS	55/74 kW (75-110 HP)	N1000001	P-11752 49	08-91	12-93	3126	K	22	22	52	29	E	4039	K	22	22	84
1.6i (ABS or NO ABS)	52 kW (71 HP)			09-93	11-95								4039	K	22	22	84
1.6i, i 16V, ABS	55/74 kW (75-101 HP)			10-95		3360	K	22	22	52	29	E					
1.7 DIESEL ABS	42 kW (57 HP)	K0000001	M1999999	10-88	07-91	3127	K	33	25	52	43	E	4039	K	22	22	84
1.7 DIESEL ABS	42 kW (57 HP)	N5000001	P-11752 49	08-91	12-93	3100	K	33	25	52	29	E	4039	K	22	22	84
1.7 TURBO DIESEL ABS	60 kW (82 HP)	M-19999 99		03-91	07-91	3127	K	33	25	52	43	E					
1.7 TURBO DIESEL ABS	60 kW (82 HP)	N1000001	P-11752 49	08-91	12-93	3100	K	33	25	52	29	E					
1.8 ABS	66 kW (90 HP)	K1000001	M-19999 99	10-88	07-91	3127	K	33	25	52	43	E					
1.8 ABS	66 kW (90 HP)	N-10000 01	P-19999 99	08-91	12-93	3100	K	33	25	52	29	E					
2.0 ABS	74/95 kW (110-130 HP)	K0000001	M-19999 99	10-88	07-91	3127	K	33	25	52	43	E					
2.0 ABS	74/95 kW (110-130 HP)	N5000001	P-19999 99	08-91	12-93	3100	K	33	25	52	29	E					
2.0 16V ABS	100/110 kW (136-150 HP)	L0000001	M-19999 99	09-89	07-91	3127	K	33	25	52	43	E					
2.0 16V ABS	100/110 kW (136-150 HP)	N5000001	P-19999 99	08-91	12-93	3100	K	33	25	52	29	E					
2.0 4WD ABS	85/110 kW (116-150 HP)	L0000001	M-19999 99	09-89	07-91	3127	K	33	25	52	43	E					
2.0 4WD ABS	85/110 kW (116-150 HP)	N5000001	P-19999 99	08-91	12-93	3100	K	33	25	52	29	E					
VECTRA (A.T.)																	
1.6 ABS	55 kW (75 HP)	K1000001	M1999999	10-88	07-91	3118	K	22	22	52	43	E					
1.6 ABS	55 kW (75 HP)	K1000001	P-11752 49	10-88	12-93	3127	K	33	25	52	43	E					
1.6 ABS	55 kW (75 HP)	N1000001	P-19999 99	08-91	12-93	3100	K	33	25	52	29	E					
1.6i, i 16V, ABS	55/74 kW (75-101 HP)			10-95		3360	K	22	22	52	29	E					
1.6i, S, ABS	55/60 kW (75-82 HP)	N1000001	P-1175249	09-88	11-95	3126	K	22	22	52	29	E					
1.7 DIESEL ABS	42 kW (57 HP)	K0000001	M-9999 99	10-88	07-91	3127	K	33	25	52	43	E					
1.7 DIESEL ABS	42 kW (57 HP)	N1000001	P-11752 49	08-91	12-93	3100	K	33	25	52	29	E					
1.8i ABS	66 kW (90 HP)	N-1000001	P-1999999	09-88	11-95	3100	K	33	25	52	29	E					
1.8i, S, ABS	65/66 kW (89-90 HP)		M-1999999	09-88	11-95	3127	K	33	25	52	43	E					
2.0 ABS	85 kW (116 HP)	K1000001	M1999999	10-88	07-91	3127	K	33	25	52	43	E					
2.0 ABS	85 kW (116 HP)	K1000001	P-19999 99	08-91	12-93	3100	K	33	25	52	29	E					



CHASSIS ↑

→ CHASSIS

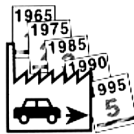

G L O N .

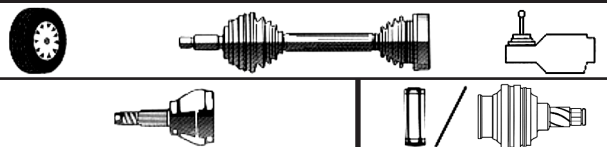

XXXX K A B C ABS P XXXX K A B C







OPEL (EUROPE)

VECTRA																			
1.7 TURBO DIESEL ABS	60 kW (82 HP)		10-95		3479	K	33	25	52	29	E								
1.8i 16V ABS	85 kW (115 HP)		10-95		3479	K	33	25	52	29	E								
2.0 Di ABS	60 kW (82 HP)		11-96		3479	K	33	25	52	29	E								
2.0i 16V ABS	100 kW (136 HP)		10-95		3479	K	33	25	52	29	E								
2.5i V6 ABS	125 kW (170 HP)		10-95		3479	K	33	25	52	29	E								
ZAFIRA																			
1.6 16V	Eng. X16XEL 74 kW (101 HP)		04-99		3478	K	33	25	52		E								
1.6 16V ABS	Eng. X16XEL 74 kW (101 HP)		04-99		3479	K	33	25	52	29	E								
1.8 16V	Eng. X18XE1 85 kW (115 HP)		04-99		3478	K	33	25	52		E								
1.8 16V ABS	Eng. X18XE1 85 kW (115 HP)		04-99		3479	K	33	25	52	29	E								
2.0 16V	Eng. X20XEV 100 kW (136 HP)		09-98		3478	K	33	25	52		E								
2.0 16V ABS	Eng. X20XEV 100 kW (136 HP)		09-98		3479	K	33	25	52	29	E								
2.0 Di	Eng. X20DTL 60 kW (82 HP)		09-99		3478	K	33	25	52		E								
2.0 Di ABS	Eng. X20DTL 60 kW (82 HP)		09-99		3479	K	33	25	52	29	E								

PEUGEOT

BOXER																			
10-14 Q ABS			01-94		3253	K	28	39	63	54	I								
18 Q			03-94		3278	K	35	45	70		I								
18 Q ABS			01-94		3254	K	35	45	70	54	I								
18 Q ABS	5235558		01-94		3465	K	35	45	70	54	I								
J5																			
TT (NO 1.9 D)			01-83	09-92	3076	K	28	27	63		I								
RANCH																			
1.8 ABS	Gear BE3 66 kW (90 HP)		07-97		3487	K	25	34	59	29	I								
1.9 DIESEL ABS	Gear BE3 50 kW (68 HP)		07-97		3487	K	25	34	59	29	I								
PARTNER																			
1.8 ABS	Gear BE3 66 kW (90 HP)		07-97		3487	K	25	34	59	29	I								
1.9 DIESEL ABS	Gear BE3 50 kW (68 HP)		07-97		3487	K	25	34	59	29	I								
205																			
1,6			06-83		3090	K	21	22	56		I								
1.8 D			06-83		3090	K	21	22	56		I								
1.9 D			06-88		3090	K	21	22	56		I								
1.9 GTi			09-86		3112	K	25	23	55,7		I								
1.9 GTi ABS			10-86	12-90	3210	K	25	34	55,7	48	I								
1.9 GTi ABS			01-91		3240	K	25	23	55,7	90	I								



	CHASSIS →	→ CHASSIS		G L O N .											
															
															
				XXXX	K	A	B	C	ABS	P	XXXX	K	A	B	C

PEUGEOT

1.9 GTi ABS (Bendix) Gearbox BE1-3 75/94 kW (102-128 HP)	10-86	12-90	3210	K	25	34	55,7	48	I						
1.9 TURBO DIESEL	10-91		3112	K	25	23	55,7		I						
305															
1.3 GEAR BOX BB8	08-82	12-89	3069	K	25	22	54,6		I						
1.5 GEAR BOX BB8 (A.T. - M.T.)	08-82	12-89	3069	K	25	22	54,6		I						
1.6 GT GEAR BOX BE1	08-82	12-89	3069	K	25	22	54,6		I						
1.9 D GEAR BOX BE1	08-82	12-89	3069	K	25	22	54,6		I						
306															
1.6 ABS	01-92		3241	K	25	23	55,7	48	I						
1.8 ABS M.T. Mod. 7 Gearbox BE3 74 kW (101 HP)	95	96	3462	K	25	34	55,3	29	I						
1.8, 2.0, 2.0 16V	01-92		3112	K	25	23	55,7		I						
1.8, 2.0, 2.0 16V ABS	01-92		3242	K	25	23	55,7	29	I						
1.8, 2.0, 2.0 16V ABS	04-93		3210	K	25	34	55,7	48	I						
1.9 D, 1.9 TURBO DIESEL	01-92		3112	K	25	23	55,7		I						
1.9 D, 1.9 TURBO DIESEL ABS	04-93		3210	K	25	34	55,7	48	I						
1.9 D, 1.9 TURBO DIESEL ABS	01-92		3242	K	25	23	55,7	29	I						
1.9 DIESEL ABS Mod. 7 Gearbox BE3 47/50/51/55 kW (64-68-69-75)	95	96	3462	K	25	34	55,3	29	I						
1.9 TURBO DIESEL ABS (BOSCH) Mod. 7 Eng. XUD9TE 66 kW (90 HP)	95	96	3462	K	25	34	55,3	29	I						
2.0, 16V ABS (M.T.) Mod.. 7 89/110/112 kW (121-149-152)	95	96	3462	K	25	34	55,3	29	I						
309															
1.9 GTi, 1.9 GTi 16V	02-87		3112	K	25	23	55,7		I						
1.9 GTi, 1.9 GTi 16V ABS	07-92		3210	K	25	34	55,7	48	I						
1.9 GTi, 1.9 GTi 16V ABS		06-92	3240	K	25	23	55,7	90	I						
1.9 TURBO DIESEL	07-89		3112	K	25	23	55,7		I						
1.9 TURBO DIESEL ABS	07-92		3210	K	25	34	55,7	48	I						
1.9 TURBO DIESEL ABS		06-92	3240	K	25	23	55,7	90	I						
1.9, GTi ABS (Bendix 48) M.T. Mod. 10, 3A, C, 88/94 kW (120-128 HP)	07-88	12-93	3210	K	25	34	55,7	48	I						
405															
1.3 GI GEAR BOX MA	08-82	04-87	3069	K	25	22	54,6		I						
1.4 GL GEAR BOX MA	05-87	01-92	3069	K	25	22	54,6		I						
1.4 GL GEAR BOX MA	01-92		3335	K	25	31	54,6		I						
1.6	05-87	01-92	3112	K	25	23	55,7		I						
1.6 ABS (BENDIX-90)	05-87	07-92	3240	K	25	23	55,7	90	I						
1.6 ABS (BOSCH-29)	05-87	07-92	3242	K	25	23	55,7	29	I						
1.6 GL, GR, SR GEAR BOX BE1	05-87	01-92	3069	K	25	22	54,6		I						
1.6 GL, GR, SR GEAR BOX BE1	01-92		3335	K	25	31	54,6		I						
1.7 TURBO DIESEL	01-92	10-95	3273	K	25	34	55,7		I						
1.7 TURBO DIESEL ABS	07-92	10-95	3308	K	25	34	55	90	I						
1.9 SRi ABS M.T. Mod. 4B, E 95 kW (129 HP)	08-92	10-96	3462	K	25	34	55,3	29	I						
1.9 D	05-87	01-92	3112	K	25	23	55,7		I						
1.9 D, 1.9 TURBO DIESEL ABS (BENDIX-90)	05-87	07-92	3240	K	25	23	55,7	90	I						
1.9 D, 1.9 TURBO DIESEL ABS (BOSCH-29)	05-87	07-92	3242	K	25	23	55,7	29	I						
1.9 GEAR BOX BE1	05-87	01-92	3069	K	25	22	54,6		I						
1.9 GEAR BOX BE1	01-92		3335	K	25	31	54,6		I						
1.9 GR, SR	05-87	01-92	3112	K	25	23	55,7		I						
1.9 T	05-87	01-92	3112	K	25	23	55,7		I						



CHASSIS ↑

↓ CHASSIS

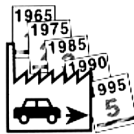

G L O N .

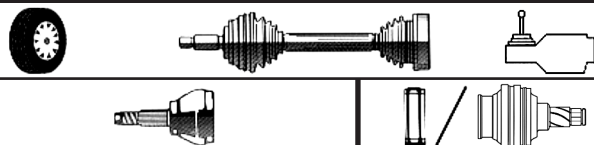







XXXX K A B C ABS P XXXX K A B C

PEUGEOT

1.9 T			01-92	10-95	3273	K	25	34	55,7		I							
1.9 T ABS (BOSCH-90)			05-87		3308	K	25	34	55	90	I							
1.9 TURBO DIESEL			01-92	10-95	3273	K	25	34	55,7		I							
1.9 TURBO DIESEL			05-87	01-92	3112	K	25	23	55,7		I							
1.9 TURBO DIESEL ABS (BENDIX-48)			05-87	07-92	3210	K	25	34	55,7	48	I							
1.9 TURBO DIESEL ABS (BOSCH-90)			05-87		3308	K	25	34	55	90	I							
1.9 TURBO DIESEL ABS M.T. Mod. 4B 66 kW (90 HP)			08-92	10-96	3462	K	25	34	55,3	29	I							
1.9, 1.9i ABS (BENDIX-90)			05-87	07-92	3240	K	25	23	55,7	90	I							
1.9, 1.9i ABS (BOSCH-29)			05-87	07-92	3242	K	25	23	55,7	29	I							
2.0, 16V, Ml 16V, ABS (BOSCH) M.T. Mod. 4B 89/110/112 kW (121-149-152 HP)			08-92	10-96	3462	K	25	34	55,3	29	I							
406																		
1.6 ABS 65 kW (88 HP)			11-95		3481	K	25	34	59	29	I							
1.8 16V ABS 81 kW (110 HP)			11-95		3481	K	25	34	59	29	I							
1.9 DIESEL, TURBO DIESEL ABS 55/66/68 kW (75-90-92 HP)			01-96		3481	K	25	34	59	29	I							
2.0 16V ABS 99 kW (135 HP)			11-95		3481	K	25	34	59	29	I							
2.0 TURBO ABS 108 kW (147 HP)			10-96		3474	K	25	34	55,7	29	I							
2.1 TURBO DIESEL 12 V ABS 80 kW (109 HP)			10-96		3474	K	25	34	55,7	29	I							
605 (M.T.)																		
2.0 gear 4GP18, XU 102C, XU 10J2, XU 10M, XUD11A			01-90		3351	K	28	23	57,7		I							
2.0 gear 4GP18, ABS (BENDIX-48) XU 102C, XU 10J2, XU 10M, XUD11A			01-90		3243	K	28	23	58	48	I							
2.1 gear 4GP18, XU 102C, XU 10J2, XU 10M, XUD11A			01-90		3351	K	28	23	57,7		I							
2.1 gear 4GP18, ABS (BENDIX-48) XU 102C, XU 10J2, XU 10M, XUD11A			01-90		3243	K	28	23	58	48	I							
3.0 gear 4GP18, ABS (BENDIX-48) XU 10J2TE, XUD11ATE			01-90		3244	K	28	27	58	48	I							
3.0 gear 4GP18, ABS (BOSCH-29) XU 10J2TE, XUD11ATE			01-90		3413	K	28	27	58	29	I							
3.0 gear 4GP18, XU 10J2TE, XUD11ATE			01-90		3352	K	28	27	57,7		I							
605 (A.T.)																		
2.0 gear 4GP18, ABS (BENDIX-48) XU 102C, XU 10J2, XU 10M, XUD11A			01-90		3243	K	28	23	58	48	I							
2.0 gear 4GP18, XU 102C, XU 10J2, XU 10M, XUD11A			01-90		3351	K	28	23	57,7		I							
2.1 gear 4GP18, ABS (BENDIX-48) XU 102C, XU 10J2, XU 10M, XUD11A			01-90		3243	K	28	23	58	48	I							
2.1 gear 4GP18, XU 102C, XU 10J2, XU 10M, XUD11A			01-90		3351	K	28	23	57,7		I							
3.0 gear 4GP18, ABS (BENDIX-48) XU 10J2TE, XUD11ATE			01-90		3244	K	28	27	58	48	I							
3.0 gear 4GP18, ABS (BOSCH-29) XU 10J2TE, XUD11ATE			01-90		3413	K	28	27	58	29	I							
3.0 gear 4GP18, XU 10J2TE, XUD11ATE			01-90		3352	K	28	27	57,7		I							
806																		
1.9 TURBO DIESEL ABS 68 kW (92 HP)			03-95		3288	K	27	39	59	48	I							
2.0 I Eng. XU10J2 89 kW (122 HP)			94		3287	K	27	34	59	48	I							
2.0i. TURBO ABS 108 kW (147 HP)			08-94		3288	K	27	39	59	48	I							
2.1 TURBO DIESEL 12V ABS 80 kW (109 HP)			08-96		3288	K	27	39	59	48	I							



	CHASSIS →	→ CHASSIS		G L O N .											
															
															
				XXXX	K	A	B	C	ABS	P	XXXX	K	A	B	C

PLYMOUTH (CHRYSLER)

ACCLAIM															
2.2 TURBO III	ACI DESIGN		01-92	12-93	3136		26	30	54		I				
2.2 TURBO III ABS	ACI DESIGN		01-92	12-93	3137		26	30	54	47	I				
2.5	ACI DESIGN		01-92	12-93	3136		26	30	54		I				
2.5 ABS	ACI DESIGN		01-92	12-93	3137		26	30	54	47	I				
2.5 TURBO	ACI DESIGN		01-92	12-93	3136		26	30	54		I				
2.5 TURBO ABS	ACI DESIGN		01-92	12-93	3137		26	30	54	47	I				
3.0 A.T.	ACI DESIGN		01-92	12-93	3136		26	30	54		I				
3.0 A.T. ABS	ACI DESIGN		01-92	12-93	3137		26	30	54	47	I				
TT	GKN DESIGN		01-89	12-90	3117	K	26	32	54		I				
TT	SAGINAW DESING		01-89	12-90	3066		26	29	54		E				
TT ABS			01-89	12-90	3159		26	29	54	47	E				
TT, A.T.			01-91	12-91	3117	K	26	32	54		I				
TT, A.T., ABS			01-91	12-91	3158	K	26	32	54	47	I				
TT, M.T. (SX)			01-91	12-91	3128	K	26	32	54		E				
TT, M.T. (DX)			01-91	12-91	3117	K	26	32	54		I				
TT, M.T., ABS (SX)			01-91	12-91	3160	K	26	32	54	47	E				
TT, M.T., ABS (DX)			01-91	12-91	3158	K	26	32	54	47	I				
CARAVELLE															
2.2	ACI DESIGN		01-87	12-88	3065		26	28	54		I				
2.2	CITROEN DESIGN		01-87	12-87	3027		26	23	54		I				
2.2	GKN DESIGN		01-88	12-88	3117	K	26	32	54		I				
2.2	SAGINAW DESIGN		01-86	12-88	3066		26	29	54		E				
2.2 (NO TURBO)	ACI DESIGN		01-84	12-86	3065		26	28	54		I				
2.2 (NO TURBO)	CITROEN DESIGN		01-84	12-85	3027		26	23	54		I				
2.2 (NO TURBO)	GKN DESIGN		01-84	12-86	3040		26	22	54		I				
2.2 TURBO	CITROEN DESIGN		01-86	12-86	3027		26	23	54		I				
2.2 TURBO			01-84	12-85	3027		26	23	54		I				
2.5	CITROEN DESIGN		01-84	12-86	3027		26	23	54		I				
2.5	GKN-1 DESIGN		01-87	12-87	3521	K	26	23	54		I				
2.5	GKN-2 DESIGN		01-87	12-87	3117	K	26	32	54		I				
2.5	GKN DESIGN		01-85	12-86	3521	K	26	23	54		I				
2.5	GKN DESIGN		01-88	12-88	3117	K	26	32	54		I				
2.5	SAGINAW DESIGN		01-86	12-88	3066		26	29	54		E				
CHAMP & COLT (NO VISTA)															
TT (NO TURBO)			01-79	12-86	3044	K	25	22	50		M				
HORIZON, TURISMO & TC3, DUSTER & MISER															
1.6			05-83	12-83	3042		26	22	54		I				
1.7			01-81	12-83	3025		26	23	54		I				
2.2			01-81	05-83	3521	K	26	23	54		I				
2.2			05-83	12-83	3042		26	22	54		I				
SPECIAL HIGH OUTPUT 2.2			01-85	12-86	3027		26	23	54		I				
TT	GKN DESIGN		01-87	12-90	3042		26	22	54		I				
TT			01-79	12-80	3024		26	23	60		I				
TT			01-84	12-84	3042		26	22	54		I				
TT (NO SPECIAL HIGH OUTPUT 2.2 & TURBO)			01-85	12-86	3042		26	22	54		I				



CHASSIS ↑

→ CHASSIS

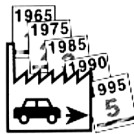
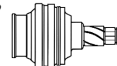





**G L O N .**

XXXX K A B C ABS P XXXX K A B C

PLYMOUTH (CHRYSLER)

TT, A.T.	ACI DESIGN			01-88	12-90	3065		26	28	54		I									
TURBO				01-85	12-86	3027		26	23	54		I									
RELIANT																					
2.2	ACI DESIGN			01-84	12-88	3065		26	28	54		I									
2.2	CITROEN DESIGN			05-83	12-85	3027		26	23	54		I									
2.2	GKN DESIGN			05-83	12-83	3042		26	22	54		I									
2.2	GKN DESIGN			01-84	12-86	3040		26	22	54		I									
2.2	SAGINAW DESIGN			01-86	12-88	3066		26	29	54		E									
2.5	CITROEN DESIGN			01-86	12-86	3027		26	23	54		I									
2.5	GKN-1 DESIGN			01-87	12-87	3521	K	26	23	54		I									
2.5	GKN-2 DESIGN			01-87	12-87	3117	K	26	32	54		I									
2.5	GKN DESIGN			01-86	12-86	3521	K	26	23	54		I									
2.5	GKN DESIGN			01-88	12-88	3117	K	26	32	54		I									
2.5	SAGINAW DESIGN			01-86	12-88	3066		26	29	54		E									
2.6	CITROEN DESIGN			01-85	12-85	3027		26	23	54		I									
2.6	GKN DESIGN			01-85	12-85	3521	K	26	23	54		I									
2.6				01-84	12-84	3027		26	23	54		I									
TT	ACI DESIGN			01-89	12-89	3065		26	28	54		I									
TT	CITROEN DESIGN			01-81	12-82	3027		26	23	54		I									
TT	GKN DESIGN			01-81	12-82	3521	K	26	23	54		I									
TT	GKN DESIGN			01-89	12-89	3117	K	26	32	54		I									
TT	SAGINAW DESIGN			01-89	12-89	3066		26	29	54		E									
TT (NO 2.2 05/83>)	CITROEN DESIGN			01-83	12-83	3027		26	23	54		I									
TT (NO 2.2 05/83>)	GKN DESIGN			01-83	12-83	3521	K	26	23	54		I									
SUNDANCE																					
2.2	ACI DESIGN			01-88	12-88	3065		26	28	54		I									
2.2	GKN DESIGN			01-88	12-88	3117	K	26	32	54		I									
2.2	SAGINAW DESIGN			01-88	12-88	3066		26	29	54		E									
2.5	GKN DESIGN			01-88	12-88	3117	K	26	32	54		I									
2.5	SAGINAW DESIGN			01-88	12-88	3066		26	29	54		E									
TT	ACI DESIGN			01-87	12-87	3065		26	28	54		I									
TT	CITROEN DESIGN			01-87	12-87	3027		26	23	54		I									
TT	SAGINAW DESIGN			01-87	12-90	3066		26	29	54		E									
TT	GKN DESIGN			01-89	12-90	3117	K	26	32	54		I									
TT (NO TURBO)	ACI DESIGN			01-89	12-90	3065		26	28	54		I									
TT ABS	SAGINAW DESIGN			01-89	12-90	3159		26	29	54	47	E									
TT, A.T. (NO TURBO)				01-91	12-92	3066		26	29	54		E									
TT, A.T. , ABS (NO TURBO)				01-91	12-92	3159		26	29	54	47	E									
TT, M.T.				01-91	12-92	3128	K	26	32	54		E									
TT, M.T., ABS				01-91	12-92	3160	K	26	32	54	47	E									
TURBO				01-91	12-92	3128	K	26	32	54		E									
TURBO ABS				01-91	12-92	3160	K	26	32	54	47	E									
SCAMP																					
TT				01-83	05-83	3521	K	26	23	54		I									
TT				05-83	12-84	3042		26	22	54		I									



	CHASSIS →	→ CHASSIS		G L O N .									
													
													
XXXX	K	A	B	C	ABS	P	XXXX	K	A	B	C		



PLYMOUTH (CHRYSLER)

VOYAGER & GRAND VOYAGER FWD															
2.5 A.T.	GKN DESIGN	01-92	12-93	3136		26	30	54		I					
4 CYL, A.T.		01-91	12-91	3117	K	26	32	54		I					
4 CYL, M.T.		01-92	12-92	3117	K	26	32	54		I					
4 CYL, M.T. (SX)		01-91	12-91	3128	K	26	32	54		E					
4 CYL, M.T., ABS (SX)		01-91	12-91	3160	K	26	32	54	47	E					
5 CYL, M.T. (DX)		01-91	12-91	3117	K	26	32	54		I					
TT	CITROEN DESIGN	01-87	12-87	3027		26	23	54		I					
TT	GKN DESIGN	01-87	12-87	3117	K	26	32	54		I					
TT		01-84	12-86	3027		26	23	54		I					
TT		01-88	12-91	3117	K	26	32	54		I					
TT ABS		01-91	12-91	3158	K	26	32	54	47	I					
V-6		01-91	12-92	3117	K	26	32	54		I					
V-6 ABS		01-91	12-92	3158	K	26	32	54	47	I					



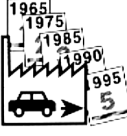

PONTIAC (GENERAL MOTORS)

BONNEVILLE															
TT		01-87	12-91	3026	K	27	32	61,5		E					
TT ABS		01-88	12-91	3154	K	27	32	61,5	47	E					
FIERO															
TT, A.T.		01-84	12-88	3017	K	33	29	47,7		E					
TT, M.T.		01-84	12-88	3063	K	33	32	47,7		E					
GRAND AM															
QUAD 4, M.T.		01-91	12-91	3063	K	33	32	47,7		E					
TT A.T. FACTORY INSTALLED ALLUMINIUM WHEELS		01-90	12-90	3063	K	33	32	47,7		E					
TT A.T. NO FACTORY INSTALLED ALLUMINIUM WHEELS		01-88	12-91	3017	K	33	29	47,7		E					
TT A.T. NO TURBO & HO QUAD 4		01-89	12-89	3017	K	33	29	47,7		E					
TT A.T.		01-85	12-87	3017	K	33	29	47,7		E					
TT M.T.		01-85	12-90	3063	K	33	32	47,7		E					
TT M.T. ABS		01-91	12-92	3155	K	33	32	63	48	E					
TURBO & QUAD 4 A.T.		01-89	12-89	3063	K	33	32	47,7		E					
TURBO & QUAD 4, M.T.	DESIGN II	01-88	12-88	3063	K	33	32	47,7		E					
GRAND PRIX															
3 SPEED A.T.		01-90	12-91	3132		33	32	73		E					
3.1 4 SPEED A.T. ABS		01-91	12-91	3133		33	32	73	47	E					
3.1 4 SPEED A.T. NO ABS		01-91	12-91	3132		33	32	73		E					
3.1 V6 A.T. 4 SPEED NO ABS		01-92	12-92	3132		33	32	73		E					

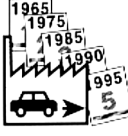

	CHASSIS ↑	→ CHASSIS		G L O N .										
														
				XXXX	K	A	B	C	ABS	P	XXXX	K	A	B
PONTIAC (GENERAL MOTORS)														
3.1, 3 SPEED, A.T.			01-92	12-92	3131		33	29	73		E			
3.4 4 SPEED ELECT A.T. ABS			01-91	12-91	3133		33	32	73	47	E			
3.4 4 SPEED ELECT A.T. NO ABS			01-91	12-91	3132		33	32	73		E			
3.4 5 SPEED M.T. ABS			01-91	12-91	3133		33	32	73	47	E			
3.4 5 SPEED M.T. NO ABS			01-91	12-92	3132		33	32	73		E			
T.T. ABS (NO '90 3 SPEED)			01-89	12-90	3133		33	32	73	47	E			
T.T. NO ABS (NO '90 3 SPEED)			01-88	12-90	3132		33	32	73		E			
LEMANS														
1.6			01-88	12-88	3039	K	22	22	52		E			
OPTIMA (CANADA)														
1.6			01-88	12-88	3039	K	22	22	52		E			
PHOENIX														
TT			01-80	12-84	3017	K	33	29	47,7		E			
TRANS SPORT														
TT			01-90	12-91	3026	K	27	32	61,5		E			
2000 SUNBIRD														
TT A.T.			01-82	12-90	3017	K	33	29	47,7		E			
TT M.T. NO TURBO			01-88	12-89	3017	K	33	29	47,7		E			
TT TURBO			01-84	12-84	3063	K	33	32	47,7		E			
TT V-6 M.T.			01-91	12-91	3063	K	33	32	47,7		E			
TURBO M.T.			01-84	12-91	3063	K	33	32	47,7		E			
6000 (A.T.)														
S.W. V-6			01-86	12-93	3026	K	27	32	61,5		E			
6000 (COUPE - SEDAN - WAGON)														
2.5, 3 SPEED, A.T.			01-90	12-90	3130		27	29	61,5		E			
3 SPEED, A.T. 20 MM DIA SPINDLE THREAD			01-84	12-84	3017	K	33	29	47,7		E			
3 SPEED, A.T. 24 MM DIA SPINDLE THREAD			01-84	12-84	3026	K	27	32	61,5		E			
4 CYL, 3 SPEED, A.T. 24 MM DIA SPINDLE THREAD			01-89	12-89	3130		27	29	61,5		E			
4 SPEED, A.T. 20 MM DIA SPINDLE THREAD			01-84	12-89	3017	K	33	29	47,7		E			
4 SPEED, A.T. 24 MM DIA SPINDLE THREAD			01-84	12-84	3026	K	27	32	61,5		E			
TT 20 MM DIA SPINDLE THREAD			01-82	12-83	3017	K	33	29	47,7		E			
TT 24 MM DIA SPINDLE THREAD			01-83	12-83	3026	K	27	32	61,5		E			
TT M.T. "785" OUTBOARD JOINT THREADED END"			01-87	12-87	3063	K	33	32	47,7		E			
V-6, 3 & 4 SPEED, A.T. "785" OUTBOARD JOINT THREADED END"			01-86	12-89	3063	K	33	32	47,7		E			
V-6, M.T. "785" OUTBOARD JOINT THREADED END"			01-88	12-88	3063	K	33	32	47,7		E			



	CHASSIS →	→ CHASSIS		G L O N .										
														
														
XXXX	K	A	B	C	ABS	P	XXXX	K	A	B	C			
PORSCHE														
993, 993 UST, 993 TIPTRONIC (differential gear side)							4302	K		28	108			
996, 996 TIPTRONIC (differential gear side)							4302	K		28	108			
PROTON (MITSUBISHI)														
ISWARA														
1,3							3044	K	25	22	50	M		
1,5							3044	K	25	22	50	M		
PREDANA														
TT (ABS)							3329	K	25	24	54	43	M	
TT (NO ABS)			01-92				3328	K	25	24	54		M	
SAGA														
1,3							3326	K	25	22	54	M		
1,5							3326	K	25	22	54	M		
WIRA														
1,6			01-94				3325	K	25	30	54		M	
1,6 (ABS)							3323	K	25	30	54	43	M	
1,8			01-94				3325	K	25	30	54		M	
1,8 (ABS)							3323	K	25	30	54	43	M	
RENAULT														
CLIO														
1.1 (B/C/571)	36 kW gear JB4/5		01-91				3300	K	21	25	56,3		E	
1.2 (B/C/572/571/A/7/04/05)	40-44 kW gear JB4/5		01-91				3300	K	21	25	56,3		E	
1.4 (B/C57T, B/C57Y)	58kW gear JB0/1		01-91				3300	K	21	25	56,3		E	
1.4 (B/C57T, B/C57Y) ABS	58kW gear JB0/1		01-91				3407	K	21	25	56,3	26	E	
1.7	68kW gear JB1/3		01-91				3300	K	21	25	56,3		E	
1.7 ABS	68kW gear JB1/3		01-91				3407	K	21	25	56,3	26	E	
1.8	70kW gear JB1/3		01-91				3300	K	21	25	56,3		E	



CHASSIS ↑

→ CHASSIS



G L O N .

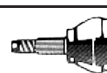

XXXX K A B C ABS P XXXX K A B C

RENAULT

1.8 (B/C57C, B/C57U)	65kW gear JB1/3	01-91		3300	K	21	25	56,3		E								
1.8 (B/C57C, B/C57U) ABS	65kW gear JB1/3	01-91		3407	K	21	25	56,3	26	E								
1.8 ABS	70kW gear JB1/3	01-91		3407	K	21	25	56,3	26	E								
1.8 RSi (B/C57H)	79kW gear JB1/3	08-94		3300	K	21	25	56,3		E								
1.8 RSi (B/C57H) ABS	79kW gear JB1/3	08-94		3407	K	21	25	56,3	26	E								
1.8i (B/C579)	80kW gear JB1/3	01-94		3300	K	21	25	56,3		E								
1.8i (B/C579) ABS	80kW gear JB1/3	01-94		3407	K	21	25	56,3	26	E								
1.9 D (B/C/S576, B/C/S57L)	47kW gear JB1/3	01-91		3300	K	21	25	56,3		E								
1.9 D (B/C/S576, B/C/S57L) ABS	47kW gear JB1/3	01-91		3407	K	21	25	56,3	26	E								
ESPACE																		
2.1 TD		01-87		3188	K	23	24	56,3		I								
FUEGO																		
TX, GTX		01-81	12-85	3095	K	23	25	56,3		E								
LAGUNA																		
1.8, SW, ABS	66/68 kW (90-92 HP)	02-94	95	3497	K	23	25	56,3	30	E								
2.0, SW, 16V, ABS	83/102 kW (113-139 HP)	02-94		3497	K	23	25	56,3	30	E								
2.2 DIESEL, TURBO DIESEL, ABS	61/83 kW (83-113 HP)	02-94		3497	K	23	25	56,3	30	E								
LAGUNA (M.T. - A.T.)																		
1.8 (ABS READY OR NON-ABS)	66/69 kW	02-94		3303	K	23	25	56,3		E								
2.0 (ABS READY OR NON-ABS)	83/103 kW	02-94		3303	K	23	25	56,3		E								
3.0 V6 (ABS READY OR NON-ABS)	123 kW	02-94		3306	K	23	29	57,5		E								
LAGUNA DIESEL (M.T.)																		
2.2 (ABS READY OR NON-ABS)	61 kW	02-94		3306	K	23	29	57,5		E								
2.2D		02-94		3306	K	23	29	57,5		E								
MEGANE																		
1.4 ABS	55 kW (75 HP)	96		3493	K	21	22	51	44	I								
1.9 DIESEL, TURBO DIESEL ABS	47/66/69 kW (64-90-94 HP)	96		3493	K	21	22	51	44	I								
2.0 Berl. Clas., Coach (Exc.16V) ABS		96		3493	K	21	22	51	44	I								
R 9 (ARGENTINA)																		
1,4	44/52 kW (60-71 HP)	11-90		3330	K	21	30	46,3		E								
R 12 TL (ARGENTINA)																		
1.5 (4V)	(SNAP RING INSTALLED)	11-93		3383	K	20	30	48		E								
1.5 (5V)		11-93		3382	K	20	30	48		I								
1.6 (4V)	(SNAP RING INSTALLED)	11-93		3383	K	20	30	48		E								
1.6 (5V)		11-93		3382	K	20	30	48		I								
R 18																		
TT				3095	K	23	25	56,3		E								
TT TURBO				3095	K	23	25	56,3		E								
R 18 DIESEL																		
TT				3095	K	23	25	56,3		E								
R 19 - CHAMADE																		
1.8 16V	gear JB3	01-91		3300	K	21	25	56,3		E								
1.8 16V ABS	gear JB3	01-91		3407	K	21	25	56,3	26	E								
R 20																		
TT		01-80	12-84	3095	K	23	25	56,3		E								



	CHASSIS →	→ CHASSIS		G L O N .											
				XXXX	K	A	B	C	ABS	P	XXXX	K	A	B	C

RENAULT

Model	Year	Year	Code	K	A	B	C	ABS	P	Code	K	A	B	C
R 20 DIESEL														
TT	01-80	12-84	3095	K	23	25	56,3		E					
R 21 - NEVADA														
2.0i TT	01-86		3095	K	23	25	56,3		E					
TT, II, III, IV SERIE			3188	K	23	24	56,3		I					
R 21 - NEVADA DIESEL														
TT			3095	K	23	25	56,3		E					
TT, II, III, IV SERIE			3188	K	23	24	56,3		I					
R 25														
TT	01-88		3095	K	23	25	56,3		E					
R 25 DIESEL														
TT	01-88		3095	K	23	25	56,3		E					
R 30														
TS, TX			3094	K	23	25	56,3		E					
R 30														
TT D, TURBO DIESEL			3095	K	23	25	56,3		E					
SAFRANE (M.T.-A.T.)														
2.0 (ABS READY OR NON-ABS) 77/97 kW	12-92		3303	K	23	25	56,3		E					
SAFRANE DIESEL (M.T.-A.T.)														
2.5 TURBO DIESEL 78/83 kW	12-92		3303	K	23	25	56,3		E					
TRAFIC														
TT BZ & DIESEL	01-81	10-84	3094	K	23	25	56,3		E					
TT BZ & DIESEL	11-84	12-89	3365	K	23	27	56,3		I					
TT BZ & DIESEL	01-90		3366	K	25	27	56,3		I					

ROVER

Model	Year	Year	Code	K	A	B	C	ABS	P	Code	K	A	B	C
ALLEGRO														
1,1			3009	K	29	19	48		I					
1,3			3009	K	29	19	48		I					
MAESTRO														
1.3 48/51 kW (65-69 HP)	01-86	12-93	3091	K	25	22	50		I					
1.3 A.T. - M.T. 48/51 kW (65-69 HP)	03-83	12-85	3164	K	25	22	50		M					
1.6 61/63 kW (82-86 HP)	01-86		3092	K	25	22	50		I					
1.6 A.T. - M.T. 61 kW (82 HP)	03-83	12-85	3164	K	25	22	50		M					
2.0, MG 2.0 76 kW (104 HP)	01-86		3092	K	25	22	50		I					
2.0, MG 2.000 A.T. - M.T. 76 kW (104 HP)	10-84	12-85	3164	K	25	22	50		M					
METRO														
1.1 A.T.- M.T.	01-90	12-94	3091	K	25	22	50		I					



CHASSIS ↑

→ CHASSIS



G L O N .

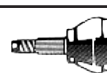

XXXX	K	A	B	C	ABS	P	XXXX	K	A	B	C
------	---	---	---	---	-----	---	------	---	---	---	---

ROVER

1.4 A.T.- M.T.		01-90	12-94	3091	K	25	22	50		I									
1.4 D		01-90	12-94	3091	K	25	22	50		I									
1.4 TURBO		01-90	12-94	3091	K	25	22	50		I									
TT			12-90	3009	K	29	19	48		I									
MINI																			
1.0		06-84		3009	K	29	19	48		I									
1.3		06-84		3009	K	29	19	48		I									
850, 1100		01-59	05-84	3006	K	19	19	48		I									
850, 1100		06-84		3009	K	29	19	48		I									
CLUBMAN, 1275		01-72		3009	K	29	19	48		I									
COOPER, S, GT	997 > 1275	01-59	12-71	3009	K	29	19	48		I									
MONTEGO																			
1,3		04-84	12-85	3164	K	25	22	50		M									
1,3	51 kW (69 HP)	01-86	12-92	3091	K	25	22	50		I									
1,6		04-84	12-85	3164	K	25	22	50		M									
1,6		01-84		3092	K	25	22	50		I									
2.0	76 kW (104 HP)	04-84	12-85	3164	K	25	22	50		M									
2.0i EFi	85 kW (115 HP)	01-86		3092	K	25	22	50		I									
111-114																			
1.1 A.T. - M.T.		01-95		3091	K	25	22	50		I									
1.4 A.T. - M.T.		01-95		3091	K	25	22	50		I									
211																			
1.1 ABS	Mod. RF 44 kW (60 HP)	11-95		3488	K	26	22	49	43	I									
213																			
1.3 A.T. - M.T.		07-84		3093	K	23	22	49		I									
214																			
1,4	66/76 kW (90-103 HP)		11-89	3093	K	23	22	49		I									
1.4 ABS		89		3433	K	26	22	49	50										
1.4i, Si, ABS	Mod. RF 55/76 kW (75-103 HP)	11-95		3488	K	26	22	49	43	I									
1.4i, Si, GSi M.T.	Mod. XW 55/66/70/76 kW (75-90-95-103 HP)	10-89	95	3104	K	26	22	49		I									
216																			
1.6 M.T.	82/90 kW (111-122 HP)	11-89	12-92	3211	K	26	23	49		M									
1.6 (A.T. - M.T.)	82/90 kW (111-122 HP)	07-84	10-89	3093	K	23	22	49		I									
1.6 Si ABS	Mod. RF 82 kW (111 HP)	11-95		3488	K	26	22	49	43	I									
1.6i		01-93		3389	K	26	23	49		I									
218																			
1,8		01-89		3220	K	26	32	55		M									
1,8		91		3436	K	26	32	49		I									
1.8 D		01-89		3220	K	26	32	55		M									
1.8 K Vi ABS	Mod. RF 107 kW (145 HP)	11-95		3488	K	26	22	49	43	I									
2.0		01-89		3220	K	26	32	55		M									
2.0 ABS		01-91		3411	K	26	32	49	27	I									
220																			
2.0		91		3436	K	26	32	49		I									
414																			
1.4 ABS		89		3433	K	26	22	49	50										



	CHASSIS →	→ CHASSIS		G L O N .										
				XXXX	K	A	B	C	ABS	P	XXXX	K	A	B

ROVER													
1.4 Si	Mod. RT 76 kW (103 HP)		05-95		3484	K	26	22	55		I		
1.4 Si ABS	Mod. RT 76 kW (103 HP)		05-95		3477	K	26	22	55	43	I		
TT			01-89		3104	K	26	22	49		I		
416													
1.6 Si	Mod. RT 82/83 kW (111-113 HP)		05-95		3484	K	26	22	55		I		
1.6 Si ABS	Mod. RT 82/83 kW (111-113 HP)		05-95		3477	K	26	22	55	43	I		
GSI			01-93		3389	K	26	23	49		I		
TT			11-89	12-92	3211	K	26	23	49		M		
418													
1,8			01-89		3220	K	26	32	55		M		
1,8			91		3436	K	26	32	49		I		
1.8 ABS			01-91		3411	K	26	32	49	27	I		
1.8 D			01-89		3220	K	26	32	55		M		
2.0			01-89		3220	K	26	32	55		M		
2.0 ABS			01-91		3411	K	26	32	49	27	I		
420													
2.0			91		3436	K	26	32	49		I		
1100, 1300													
TT			01-62		3009	K	29	19	48		I		

SAAB													
90													
2.0	73 kW (100 HP)		01-85	12-87	3189	K	25	25	56,6		E		
99													
2.0	73/87 kW (100-118 HP)		01-75	12-82	3232	K	30	25	46,9		E		
2.0	73/87 kW (100-118 HP)	C6010842	01-82	12-84	3189	K	25	25	56,6		E		
900 (A.T.)													
2.0 16V ABS (29 TEETH)	96 kW (131 HP)		07-93		3350	K	33	25	52	29	E		
2.0 16V TURBO ABS (29 TEETH)	132/136 kW (180-185 HP)		07-93		3350	K	33	25	52	29	E		
2.0 TURBO (B201)	107 (145 HP)		01-81	12-85	3189	K	25	25	56,6		E		
2.3 16V ABS (29 TEETH)	110 kW (150 HP)		07-93		3350	K	33	25	52	29	E		
2.5 V6 ABS (29 TEETH)	125 kW (150 HP)		07-93		3350	K	33	25	52	29	E		
900 (M.T.)													
2.0 (B201) 4-SPEED	74/81 kW (100-110 HP)		01-81	12-87	3189	K	25	25	56,6		E		
2.0 (B201) 5-SPEED	74/81 kW (100-110 HP)		01-81	12-87	3189	K	25	25	56,6		E		
2.0 (B201-BI20)	74/85 kW (100-115 HP)		01-88	07-93	3099	K	25	25	56		E		
2.0 16V ABS (29 TEETH)	96 kW (131 HP)		07-93		3350	K	33	25	52	29	E		



CHASSIS ↑

→ CHASSIS

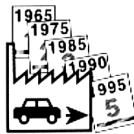

G L O N .

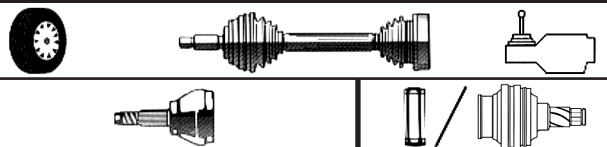



XXXX	K	A	B	C	ABS	P	XXXX	K	A	B	C
------	---	---	---	---	-----	---	------	---	---	---	---

SAAB

2.0 16V TURBO (B202)	118/129 kW (160-175 HP)	01-84	12-87	3189	K	25	25	56,6		E													
2.0 16V TURBO (B202-B212)	93/104 kW (126-142 HP)	01-88	07-93	3099	K	25	25	56		E													
2.0 16V TURBO ABS (29 TEETH)	132/136 kW (180-185 HP)	07-93		3350	K	33	25	52	29	E													
2.0 16V TURBO ABS (B202-B212)	93/104 kW (126-142 HP)	01-86	12-89	3224	K	25	25	56	94	E													
2.0 16V TURBO ABS (B202-B212)	93/104 kW (126-142 HP)	12-90	07-93	3338	K	25	25	79	46	E													
2.0 ABS (B201-BI20) (46 TEETH)	74/85 kW (100-115 HP)	01-89	07-93	3338	K	25	25	79	46	E													
2.0 ABS (B201-BI20) (94 TEETH)	74/85 kW (100-115 HP)	01-86	12-88	3224	K	25	25	56	94	E													
2.0 S	80/87 kW (100-118 HP)	01-78	12-80	3232	K	30	25	46,9		E													
2.0 TURBO (B201)	107 (145 HP)	01-81	12-85	3189	K	25	25	56,6		E													
2.3 16V ABS (29 TEETH)	110 kW (150 HP)	07-93		3350	K	33	25	52	29	E													
2.5 V6 ABS (29 TEETH)	125 kW (150 HP)	07-93		3350	K	33	25	52	29	E													
900-II CABRIO - COUPE' (A.T.)																							
2.0 16V ABS (29 TEETH)	96 kW (131 HP)	07-94		3350	K	33	25	52	29	E													
2.0 16V TURBO ABS (29 TEETH)	132/136 kW (180-185 HP)	07-94		3350	K	33	25	52	29	E													
2.3 16V ABS (29 TEETH)	110 kW (150 HP)	07-94		3350	K	33	25	52	29	E													
2.5 V6 ABS (29 TEETH)	125 kW (150 HP)	07-94		3350	K	33	25	52	29	E													
900-II CABRIO - COUPE' (M.T.)																							
2.0 16V ABS (29 TEETH)	96 kW (131 HP)	07-94		3350	K	33	25	52	29	E													
2.0 16V TURBO ABS (29 TEETH)	132/136 kW (180-185 HP)	07-94		3350	K	33	25	52	29	E													
2.3 16V ABS (29 TEETH)	110 kW (150 HP)	07-94		3350	K	33	25	52	29	E													
2.5 V6 ABS (29 TEETH)	125 kW (150 HP)	07-94		3350	K	33	25	52	29	E													
9000-9000 CD (A.T.)																							
2.0 16, CS, TURBO	92/94/96/127 kW (125-128-130-173 HP)	85	12-89	3073	K	26	25	56,5		E													
2.0 16V (B202)	92/98 kW (125-133 HP)	01-85		3073	K	26	25	56,5		E													
2.0 16V ABS (B202)	92/98 kW (125-133 HP)	01-85	12-89	3339	K	26	25	79	94	E													
2.0 16V ABS (B202)	92/98 kW (125-133 HP)	12-90		3223	K	26	25	56	46	E													
2.0 16V TURBO	118/129 kW (160-175 HP)	01-85	12-89	3073	K	26	25	56,5		E													
2.0 16V TURBO ABS	118/129 kW (160-175 HP)	01-85	12-89	3339	K	26	25	79	94	E													
2.3 16V (B234)	107/110 kW (145-150 HP)	09-89		3073	K	26	25	56,5		E													
2.3 16V (B234) ABS	107/110 kW (145-150 HP)	09-89		3223	K	26	25	56	46	E													
2.3 16V TURBO (B234)	142/147 kW (194-200 HP)	01-90		3230	K	26	25	56,5		E													
2.3 16V TURBO ABS (B234)	142/147 kW (194-200 HP)	01-90		3231	K	26	25	56	46	E													
2.3 16V, CDE, CS, CSE	107/108 kW (145-147)	09-89		3073	K	26	25	56,5		E													
9000-9000 CD (M.T.)																							
2.0 16, CS, TURBO	92/94/96/127 kW (125-128-130-173 HP)	85	12-89	3073	K	26	25	56,5		E													
2.0 16V (B202)	92/98 kW (125-133 HP)	01-85		3073	K	26	25	56,5		E													
2.0 16V ABS (B202)	92/98 kW (125-133 HP)	01-85	12-89	3339	K	26	25	79	94	E													
2.0 16V ABS (B202)	92/98 kW (125-133 HP)	12-90		3223	K	26	25	56	46	E													
2.0 16V TURBO	118/129 kW (160-175 HP)	01-85	12-89	3073	K	26	25	56,5		E													
2.0 16V TURBO ABS	118/129 kW (160-175 HP)	01-85	12-89	3339	K	26	25	79	94	E													
2.3 16V, CDE, CS, CSE	107/108 kW (145-147 HP)	09-89		3073	K	26	25	56,5		E													
2.3 16V (B234)	107/110 kW (145-150 HP)	09-89		3073	K	26	25	56,5		E													
2.3 16V (B234) ABS	107/110 kW (145-150 HP)	09-89		3223	K	26	25	56	46	E													
2.3 16V TURBO (B234)	142/147 kW (194-200 HP)	01-90		3230	K	26	25	56,5		E													
2.3 16V TURBO ABS (B234)	142/147 kW (194-200 HP)	01-90		3231	K	26	25	56	46	E													

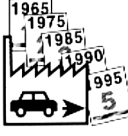

	CHASSIS →	→ CHASSIS		G L O N .										
														
				XXXX	K	A	B	C	ABS	P	XXXX	K	A	B
SAAB														
9000 (A.T./M.T.)														
2.0 TURBO 16V 118/127/129 kW (160-173-175 HP)			85	12-89	3073	K	26	25	56,5		E			
9000 (AUSTRALIA, USA)														
2.0 Mod. C55 Eng.B20			03-85	89	3073	K	26	25	56,5		E			
2.0 Mod. C55T Eng. B20			03-85	89	3073	K	26	25	56,5		E			
SAVEL-ERAD														
AGORA					3115	K	18	18	42		E	4015	K	18 18 62
SPACIA					3115	K	18	18	42		E	4015	K	18 18 62
SEAT														
AROSA (A.T./M.T.)														
1.0 37 kW (50 HP)			05-97		3307	K	22	30	53		I	4005	K	33 91,8
1.4 44/55 kW (60-75 HP)			05-97		3307	K	22	30	53		I	4005	K	33 91,8
1.7 SDi 44 kW (60 HP)			08-97		3307	K	22	30	53		I	4005	K	33 91,8
CORDOBA														
1,05 AAU, AAV, ABD, ABU, 2G, 1Y					3548	K	22	30	51		I			
1,3 AAU, AAV, ABD, ABU, 2G, 1Y					3548	K	22	30	51		I			
1,4 AAU, AAV, ABD, ABU, 2G, 1Y			06-94		3548	K	22	30	51		I			
1,6 AAU, AAV, ABD, ABU, 2G, 1Y			10-94		3548	K	22	30	51		I			
1,8 AAZ, ABS, ADL, 2E			10-94		3547	K	22	30	51		I			
1.8 16V AAZ, ABS, ADL, 2E			10-93		3547	K	22	30	51		I			
2.0 2E			10-93		3547	K	22	30	51		I			
2.0i 16V (M.T.) Mod. 6K/C 110 kW (149 HP)			08-96		3340	K	36	30	53		I			
CORDOBA DIESEL														
1.9 D AAU, AAV, ABD, ABU, 2G, 1Y			06-92		3548	K	22	30	51		I	4511	K	33 94
1.9 TURBO D AAZ, ABS, ADL, 2E			10-93		3547	K	22	30	51		I			
CRONO														
TT					3012	K	22	25	48		I			



CHASSIS ↑

→ CHASSIS

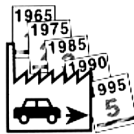

G L O N .

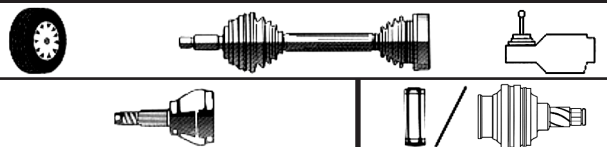



XXXX	K	A	B	C	ABS	P	XXXX	K	A	B	C
------	---	---	---	---	-----	---	------	---	---	---	---

SEAT

IBIZA																			
0,903	32 kW (44 HP)		01-86	04-93	3504	K	22	20	48		E								
1,05	AAU		01-93		3548	K	22	30	51		I								
1,2	44/51 kW (60-70 HP)		01-84	04-93	3504	K	22	20	48		E								
1,3	AAV, 2G		01-93		3548	K	22	30	51		I								
1,4	ABD		01-93		3548	K	22	30	51		I								
1,5	63/74 kW (85-100 HP)		01-84	04-93	3504	K	22	20	48		E								
1,6	AB U		01-93		3548	K	22	30	51		I								
1,8	ABS		01-93		3547	K	22	30	51		I								
1.8 16V	ADL		01-93		3547	K	22	30	51		I								
2.0	2E		01-93		3547	K	22	30	51		I								
IBIZA DIESEL																			
1.7 D	41 kW (55 HP)		01-84	04-93	3504	K	22	20	48		E								
1.9 D	1Y		10-93		3548	K	22	30	51		I								
1.9 TURBO D	AAZ		10-93		3547	K	22	30	51		I								
MALAGA																			
1,2	44/47 kW (60-63 HP)		05-85	12-92	3504	K	22	20	48		E								
1,5	63/74 kW (85-100 HP)		05-85	12-92	3504	K	22	20	48		E								
MALAGA DIESEL																			
1.7 D	41 kW (55 HP)		05-85	12-92	3504	K	22	20	48		E								
MARBELLA																			
850	25 kW (25 HP)		01-87	12-93	3501	K	20	20	43,1		E								
900	29/33 kW (40-45 HP)		01-87	12-93	3501	K	20	20	43,1		E								
1000	(44-45 HP)		01-87	12-93	3501	K	20	20	43,1		E								
MARBELLA DIESEL																			
1300 D	(37 HP)		01-87	12-93	3501	K	20	20	43,1		E								
PANDA																			
850			03-80	12-85	3501	K	20	20	43,1		E								
903			03-80		3501	K	20	20	43,1		E								
RITMO																			
TT					3012	K	22	25	48		I								
RONDA																			
1,2			01-78	12-87	3504	K	22	20	48		E								
1.3 (65-75 HP)			01-78	12-87	3504	K	22	20	48		E								
1.5 (75 HP)			01-78		3012	K	22	25	48		I								
1,5	63 kW (85 HP)		01-84	12-87	3504	K	22	20	48		E								
1.6 (90-105 HP)			05-81		3012	K	22	25	48		I								
1,6	68 kW (93 HP)		01-84	12-87	3504	K	22	20	48		E								
RONDA DIESEL																			
1.7 D	41 kW (55 HP)		01-84	12-87	3504	K	22	20	48		E								
TERRA																			
903	31/33 kW (42-45 HP)		01-81		3501	K	20	20	43,1		E								
TERRA DIESEL																			
1.3 D			01-81		3501	K	20	20	43,1		E								
1.4 D			01-81		3501	K	20	20	43,1		E								

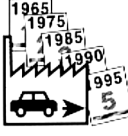

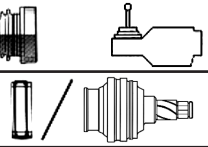
	CHASSIS →	→ CHASSIS		G L O N .														
																		
				XXXX	K	A	B	C	ABS	P	XXXX	K	A	B	C			
SEAT																		
TOLEDO																		
1,6	EZ, ABN, 1F		05-91		3547	K	22	30	51		I							
1,8	RP		05-91		3547	K	22	30	51		I							
1,8 16V	RP		05-91		3547	K	22	30	51		I							
2.0	2E		05-91		3547	K	22	30	51		I							
2.0i 16V (M.T.)	Mod. 1L 110 kW (149 HP)		11-93		3340	K	36	30	53		I							
2.0ie	(156 HP)		03-94		3340	K	36	30	53		I							
TOLEDO DIESEL																		
1.9 D	1Y		05-91		3548	K	22	30	51		I	4511	K		33	94		
1.9 TAXI			05-91		3547	K	22	30	51		I	4511	K		33	94		
1.9 TURBO D	AAZ		05-91		3547	K	22	30	51		I	4511	K		33	94		
TRANS																		
903					3501	K	20	20	43,1		E							
127 FURA																		
900			01-72	12-86	3501	K	20	20	43,1		E							
1000			03-80	12-86	3501	K	20	20	43,1		E							
128																		
TT			01-80		3501	K	20	20	43,1		E							
SECMA																		
MA-GOO 50					3115	K	18	18	42		E	4015	K	18	18	62		
SKODA																		
FAVORIT																		
1,3	41/46 kW (56-62 HP)		08-87		3119	K	22	22	45		I							
FELICIA																		
1,3	40 kW		01-95		3119	K	22	22	45		I							
FORMAN																		
1,3	41/46 kW (56-62 HP)		08-87		3119	K	22	22	45		I							
OCTAVIA																		
1,6, SW (A.T.)	Mod. 1U 55/74 kW (75-101 HP)		09-96		3340	K	36	30	53		I							
1,6, SW (M.T.)	Mod. 1U 55/74 kW (75-101 HP)		09-96		3432	K	36	30	53		I							
1,8 20V (A.T./M.T.)	Mod. 1U 92 kW (125 HP)		09-96		3340	K	36	30	53		I							
1,9 SDi, SW M.T.	Mod. 1U 50 kW (68 HP)		07-98		3432	K	36	30	53		I	4511	K		33	94		
1,9 TURBO DIESEL (A.T./M.T.)	66 kW (90 HP)		09-96		3340	K	36	30	53		I							



CHASSIS ↑

→ CHASSIS



G L O N .

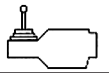

XXXX K A B C ABS P XXXX K A B C

SUBARU

ALCYONE																			
1.8T Mod. AX4-AX7, 4WD	Eng. EA82T		01-85		3191	K	30	25	58		M								
BRAT (USA)																			
2WD			01-82	12-84	3070	K	30	23	52		M								
4WD			01-85	12-91	3190	K	30	23	58		M								
BRUMBY (Australia)																			
1.6 4WD Mod. A69	Eng. EA71 FWD		01-77	12-79	3070	K	30	23	52		M								
1.6 4WD Mod. A69	Eng. EA71 RWD		01-77	12-79	3028	K	30	22	52		M								
1.8 4WD Mod. JF2	Eng. EA81 RWD		12-79	12-92	3028	K	30	22	52		M								
1.8 4WD Mod. JF2	Eng. EA81 FWD		12-79	12-82	3190	K	30	23	58		M								
1.8 4WD Mod. JF2	Eng. EA81 FWD		01-93	01-94	3070	K	30	23	52		M								
COUPE' 3 DOOR																			
2WD A.T. NO TURBO			01-85	12-89	3190	K	30	23	58		M								
2WD M.T. NO TURBO			01-85	12-89	3054	K	30	22	58		M								
4WD TURBO			01-85	12-89	3190	K	30	23	58		M								
TT TURBO			01-85	12-89	3191	K	30	25	58		M								
HATCHBACK																			
4WD			01-85	12-89	3190	K	30	23	58		M								
IMPREZA																			
1.6 2WD			01-93		3229	K	27	22	56		M								
1.6 4WD			01-93		3229	K	27	22	56		M								
1.8 4WD			01-93		3229	K	27	22	56		M								
2.0 4WD			01-93		3229	K	27	22	56		M								
JUSTY																			
700					3258	K	24	18	50		M								
1000	J10 - KA5 Engine EF10		01-84	12-88	3259	K	24	19	50		M								
1200 M.T.	KA8, KAD A Eng. EF12, 4WD 49 kW (67 HP)		01-87	05-91	3390	K	27	21	50		M								
LEGACY																			
1.8 Mod. BC2 (A.T/M.T.)	Eng. EJ18		01-89		3192	K	27	30	56		M								
1.8 4WD Mod. BC3-BF3 (M.T.)	Eng. EJ18		01-89		3192	K	27	30	56		M								
1.8 4WD Mod. BC3-BF3 (A.T.)	Eng. EJ18		01-89		3229	K	27	22	56		M								
2.0 2WD BC4	EJ20		11-89		3294	K	27	25	56		M								
2.0 GT T			01-91		3294	K	27	25	56		M								
2.0T 4WD Mod. BC4-BC5-BF5-BFA	Eng. EJ20		01-89		3192	K	27	30	56		M								
2.2 4WD Mod. BC4-BF5-BF4	Eng. EJ22		01-89		3192	K	27	30	56		M								
LEGACY COUPE'																			
1.8 4WD Mod. BC3-BF3 (A.T.)	Eng. EJ18		01-89		3229	K	27	22	56		M								
1.8 GL 4WD A.T. FWD			01-89		3192	K	27	30	56		M								
2.0 GL 4WD A.T. FWD			01-91		3192	K	27	30	56		M								
2.2 GX 4WD A.T. FWD			01-92		3192	K	27	30	56		M								
TURBO (USA)			01-90	12-93	3192	K	27	30	56		M								
LEONE 2WD																			
AA2, AP2	EA71 1600		01-84		3054	K	30	22	58		M								
AA4	EA82 1800		01-84		3054	K	30	22	58		M								
AB2, AM1	EA71 1600		01-79	12-84	3028	K	30	22	52		M								
AF1, AF2	EA65 1300		01-79	12-84	3028	K	30	22	52		M								



	CHASSIS →	→ CHASSIS	1965 1975 1985 1990 1995 5	G L O N .													
				XXXX		K	A	B	C	ABS	P	XXXX		K	A	B	C
SUBARU																	
AM2, AB4	EA81 1800		01-79	12-84	3028	K	30	22	52		M						
LEONE 4WD																	
AA3, AL3	EA71 1600		01-84		3190	K	30	23	58		M						
AA5 TURBO	EA82T 1800		01-84		3191	K	30	25	58		M						
AA5, AL5	EA82 1800		01-84		3190	K	30	23	58		M						
AF3, AM3	EA71 1600		01-79	12-84	3070	K	30	23	52		M						
AF5, AB5	EA81 1600		01-79	12-84	3070	K	30	23	52		M						
AG5, AA7 TURBO			01-84		3191	K	30	25	58		M						
AL7, AG6 TURBO			01-84		3191	K	30	25	58		M						
AM5, AJ5			01-79	12-84	3070	K	30	23	52		M						
LIBERTY (AUSTRALIA)																	
2.2 JF1	Eng. EJ22		01-89	12-91	3294	K	27	25	56		M						
2.2 4WD JF1-JF2	Eng. EJ22		01-89	12-91	3294	K	27	25	56		M						
LOYALE (USA)																	
2WD NO TURBO			01-85	12-91	3190	K	30	23	58		M						
2WD TURBO			01-89	12-91	3191	K	30	25	58		M						
TT 4WD			01-85	12-91	3190	K	30	23	58		M						
REX																	
KH1C (M.T.)	ENO5 550		03-90		3198	K	24	18	50		M						
KH1C (M.T.)	ENO5 550		03-90		3199	K	24	19	50		M						
KH3D (M.T.)	ENO7 660		03-90		3199	K	24	19	50		M						
KH3D (M.T.)	ENO7 660		03-92		3198	K	24	18	50		M						
KH4D	ENO7 660		03-92		3199	K	24	19	50		M						
KHC2 (M.T.)	ENO5 550		03-90		3199	K	24	19	50		M						
KP1C (A.T.)	ENO5 550		06-89		3198	K	24	18	50		M						
KP1C (M.T.)	ENO5 550		06-89		3198	K	24	18	50		M						
KP1C (M.T.)	ENO5 550		06-89		3199	K	24	19	50		M						
KP3D (A.T.)	ENO7 660		03-90		3198	K	24	18	50		M						
KP3D (M.T.)	ENO7 660		03-90		3198	K	24	18	50		M						
SEDAN & WAGON																	
2WD DL, GL 1.8 A.T. NO TURBO			01-85	12-89	3054	K	30	22	58		M						
2WD DL, GL 1.8 M.T. NO TURBO			01-85	12-86	3054	K	30	22	58		M						
2WD GL-10 1.8 FI NO TURBO			01-86	12-89	3054	K	30	22	58		M						
2WD, 4WD 1.8 FI A.T.			01-85	12-89	3191	K	30	25	58		M						
4WD 1.8 FI			01-88	12-89	3191	K	30	25	58		M						
VORTEX (AUSTRALIA)																	
1.8 Mod. JF1	Eng. EA82		01-85	12-89	3191	K	30	25	58		M						
1.8T Mod. JF1	Eng. EA82		01-85	12-89	3191	K	30	25	58		M						



CHASSIS ↑

→ CHASSIS

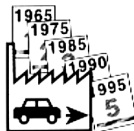

G L O N .

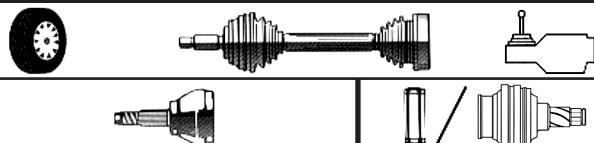

XXXX	K	A	B	C	ABS	P	XXXX	K	A	B	C
------	---	---	---	---	-----	---	------	---	---	---	---

SUZUKI

Model		Year 1	Year 2	Code	K	A	B	C	ABS	P	Code	K	A	B	C
ALTO (M.T.)															
0.8 Mod. EC (GA, GL) (SB308/CA) Eng. F8B 29 kW (39 HP)		01-86	11-93	3532	K	23	19	44		M					
ALTO, CERVO, FRONTE, MEHERAN															
CA71 F5A 800		01-84	12-89	3122	K	23	18	44		M					
CB71/72 F5A 800		01-84	12-89	3122	K	23	18	44		M					
CC71/72 F5A 800		01-84	12-89	3122	K	23	18	44		M					
SB308 F5A 800		01-84	12-89	3122	K	23	18	44		M					
SS30 E5A 500		01-79	12-84	3532	K	23	19	44		M					
SS40 E5A 500		01-79	12-84	3532	K	23	19	44		M					
SS80 E5A 500		01-79	12-84	3532	K	23	19	44		M					
BALENO															
1.3 M.T.				3444	K	25	19	49		I					
1.6		01-95		3418	K	25	21	49		I					
1.6		01-98		3508	K	25	20	49		M					
1.6 ABS (DX)				3442	K	25	20	49	42						
1.6 ABS (SX)				3441	K	25	21	49	42						
CULTUS, FORSA, SWIFT															
1.3 AA34 G13BA		01-90		3417	K	25	22	49		M					
1.6 AH14 G16B		01-90		3417	K	25	22	49		M					
AA33, AA53 G13A 1300		01-86	08-89	3532	K	23	19	44		M					
AB33, AB53 G13B		01-86	08-89	3532	K	23	19	44		M					
AB34 (M.T.) G 10 1000		01-88		3281	K	23	19	49		M					
AB41/43 1300		01-86	08-89	3532	K	23	19	44		M					
AB44S (M.T.) G 13 B1300		01-88		3281	K	23	19	49		M					
CR225 (A.T.) F6A		01-88		3281	K	23	19	49		M					
SA310 G10 1000		01-84	08-89	3532	K	23	19	44		M					
SA410 (M.T.) G13A 1300		01-84	08-89	3532	K	23	19	44		M					
SF310 (A.T.)		01-88		3281	K	23	19	49		M					
MARUTI															
800 SB308		01-85	12-92	3532	K	23	19	44		M					
800		01-86		3122	K	23	18	44		M					
800 OLD				3125	K	23	19	44		M					
MIGHTY BOY (AUSTRALIA)															
500 Mod. SS40T-ST31 Eng. F5		01-80	12-90	3532	K	23	19	44		M					
SAMURAI															
TT		01-86	12-95	3532	K	23	19	44		M					
SWIFT (AUSTRALIA)															
1.3 Mod. G13A Eng. SAEA		01-89	12-91	3532	K	23	19	44		M					
SWIFT															
1.0 Mod.. AB34 Eng. G10 OHC A.T./ M.T.		09-89	12-94	3281	K	23	19	49		M					
1.0, i(A.T./M.T.) Mod. EA GL (SF310, AA44) Eng. G10A 37/39/40 kW (50-53-55 HP)		03-89	12-90	3281	K	23	19	49		M					
1.0 (M.T.) Mod. AA (GA, GL, GLS) SA310, AA41/43) Eng. G10A 37 kW (50 HP)		10-83	03-89	3532	K	23	19	44		M					
1.3 AA34 G13BA		01-90		3417	K	25	22	49		M					
1.3 Mod. AB44S-SF310 Eng. G13B OHC A.T./ M.T.		09-89	12-94	3281	K	23	19	49		M					
1.3 (A.T./M.T.) Mod. EA (GS GL) (SF413, AB35) Eng. G13A 50 kW (68 HP)		03-89		3281	K	23	19	49		M					
1.3 (M.T.) Mod. AA (GC, GL, GLX) (SA413, AA51) Eng. G13A 50 kW (68 HP)		10-84	03-89	3532	K	23	19	44		M					



	CHASSIS →	→ CHASSIS		G L O N .											
				XXXX	K	A	B	C	ABS	P	XXXX	K	A	B	C

SUZUKI												
1.3 (M.T.) Mod. AA GL (SA413, AA53) Eng. G13A 47 kW (64 HP)			08-86	03-89	3532	K	23	19	44		M	
1.3 (M.T.) Mod. AA GS (SA413, AA51/53) Eng. G13A 54 kW (73 HP)			10-84	03-89	3532	K	23	19	44		M	
1.3 (M.T.) Mod. EA (GL, GS) (SF413, AB35) Eng. G13A 52 kW (71 HP)			03-89	12-91	3281	K	23	19	49		M	
1.3 (M.T.) Mod. EA GL 4WD (SF413, AA/AF35) Eng. G13A 50/52 kW (68-71 HP)			03-89	12-91	3281	K	23	19	49		M	
1.3 ABS AA34 G13BA			92		3443	K	25	22	49	42	I	
1.6 AH14 G16B			01-90		3417	K	25	22	49		M	
1.6 ABS AH14 G16B			92		3443	K	25	22	49	42	I	
1.6 L (A.T.)			01-89	12-93	3289	K	23	22	49		M	
1.6 L (M.T.)			01-89	12-93	3289	K	23	22	49		M	

TASSO																
C1DB					3115	K	18	18	42		E	4015	K	18	18	62
C1DM					3115	K	18	18	42		E	4015	K	18	18	62

TOYOTA												
CAMRY, VISTA												
2.2 L			01-92	12-96	3375	K	26	32	56		I	
2.2 L ABS			01-92	12-96	3427	K	26	32	56	48	I	
2.5 L V6 ABS (U.S.A.)			01-90		3427	K	26	32	56	48	I	
2.5 L V6 (U.S.A.)			01-90		3375	K	26	32	56		I	
3.0			01-92		3395	K	30	34	56		I	
3.0 ABS			01-92		3394	K	30	34	56	48	I	
4 Cyl. A.T. (U.S.A.)			88	92	3437	K	26	30	56		I	
CV10, CV11	1C-TL 1800		01-82	12-86	3050	K	26	24	56		I	
CV20	1S-I 1800		01-86		3050	K	26	24	56		I	
CV20	2C-T 2000		01-86	12-88	3050	K	26	24	56		I	
CV20 A.T.	2C-T 2000		01-88		3050	K	26	24	56		I	



CHASSIS ↑

→ CHASSIS

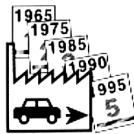
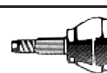

**G L O N .**

XXXX	K	A	B	C	ABS	P	XXXX	K	A	B	C
------	---	---	---	---	-----	---	------	---	---	---	---

TOYOTA

CV21 (NO GT)	3S-FE 2000		01-86		3050	K	26	24	56		I								
CV22	4S-FI 1600		01-86		3050	K	26	24	56		I								
CV40	3C-T 2.2		07-94		3295	K	26	27	56		I								
SV10	1S-LU 1800		01-82	12-84	3050	K	26	24	56		I								
SV10	1S-ILU 1800		01-84	12-86	3050	K	26	24	56		I								
SV11	2S-ELU 2000		01-82	12-84	3050	K	26	24	56		I								
SV11	2S-ILU 2000		01-84	12-86	3050	K	26	24	56		I								
SV32-SV33	3S-FE 2.0		01-90	12-91	3295	K	26	27	56		I								
SV32-SV33			90		3445	K	26	27	56	48									
VZV20 A.T.	1VZ-FE 2000		01-88		3050	K	26	24	56		I								
CARINA, CELICA, CORONA																			
2.0 Mod. ST182-ST183	Eng. 3F-FE		01-89	12-91	3295	K	26	27	56		I								
AT160	4A-GELU 1600		01-85		3050	K	26	24	56		I								
CT150	2C-L 2000		01-83	12-85	3050	K	26	24	56		I								
ST150	1S-LU 1800		01-83	12-88	3050	K	26	24	56		I								
ST151	1S-ELU, 1S-ILU		01-84	12-88	3050	K	26	24	56		I								
ST160	1S-ILU		01-85	12-88	3050	K	26	24	56		I								
ST162	1S-ELU		01-85	12-88	3050	K	26	24	56		I								
ST162	3S-FE 1800, 2000		01-85	12-88	3050	K	26	24	56		I								
ST162	3S-GE		01-85	12-88	3235	K	26	25	56		I								
ST171	3S-GELU 2000		01-85	12-88	3235	K	26	25	56		I								
CARINA, COROLLA, CORONA, SPRINTER																			
AE80, AE81	4ALU 1600		01-83	12-85	3049	K	26	23	56		I								
AT150	2ALU 1300		01-83	12-85	3049	K	26	23	56		I								
AT151	3ALU 1500		01-83	12-85	3049	K	26	23	56		I								
CE80	1CL 1800		01-83	12-85	3050	K	26	24	56		I								
CT151	2CL 2000		01-83	12-85	3050	K	26	24	56		I								
EE80	2ELU 1300		01-83	12-85	3049	K	26	23	56		I								
COROLLA																			
1.8i ABS			06-91		3399	K	26	24	56	48	I								
AE82 M.T.			01-84	12-87	3050	K	26	24	56		I								
AE91	5A-FE 1500		01-87		3049	K	26	23	56		I								
AE92 M.T.	4A-GELU 1600		01-84		3050	K	26	24	56		I								
AE92 A.T.	5A-F 1500		01-87		3049	K	26	23	56		I								
AE98	3E 1500		01-87		3049	K	26	23	56		I								
CE90, CE96	1C 1800		01-87		3050	K	26	24	56		I								
CE97			01-87		3050	K	26	24	56		I								
COUPE' GT-S			01-88	12-91	3596	K	26	29	56		E								
EE90	2E 1300		01-87		3049	K	26	23	56		I								
EE96V	2E 1300		01-87		3050	K	26	24	56		I								
EE97G			01-87		3049	K	26	23	56		I								
FX M.T.			01-87	12-88	3596	K	26	29	56		E								
COROLLA (SOUTH AFRICA)																			
180 I GSE			96		3399	K	26	24	56	48	I								
RS I 20V			97		3399	K	26	24	56	48	I								
RX I			99		3399	K	26	24	56	48	I								

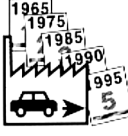

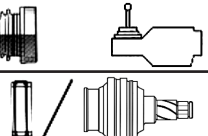
	CHASSIS →	→ CHASSIS		G L O N .														
																		
				XXXX	K	A	B	C	ABS	P	XXXX	K	A	B	C			
TOYOTA																		
HILUX																		
3.4 DIESEL FWD M.T. Mod. BJ70,73, 74 Eng. 13B			01-86		3463	K	30	27	61,76		I							
3.5 Mod. J77 Eng. 1PZ			90		3463	K	30	27	61,76		I							
4.0 Mod. J80 Eng. 3FE			90		3463	K	30	27	61,76		I							
4.0 DIESEL FWD M.T. Mod. HJ60 Eng. 2H			10-81	01-88	3463	K	30	27	61,76		I							
4.0 TURBO DIESEL Mod. HJ61 Eng. 12HT			08-87	12-89	3463	K	30	27	61,76		I							
4.2 Mod. J73, 81 Eng. 1HZ			90		3463	K	30	27	61,76		I							
4.2 Mod. J80, 81 Eng. 1HZ, 1HDT			10-89		3464	K	30	24	57		I							
4.2 FWD M.T. Mod. FJ, HJ62 Eng. 3F			01-84	12-86	3463	K	30	27	61,76		I							
LANDCRUISER																		
3.4 DIESEL FWD M.T. Mod. BJ70, 73,74 Eng. 13B			01-86		3463	K	30	27	61,76		I							
3,5 Mod. J77 Eng. 1PZ			90		3463	K	30	27	61,76		I							
4.0 Mod. J80 Eng. 3FE			90		3463	K	30	27	61,76		I							
4.0 DIESEL FWD M.T. Mod. HJ60 Eng. 2H			10-81	01-88	3463	K	30	27	61,76		I							
4.0 TURBO DIESEL Mod. HJ61 Eng. 12HT			08-87	12-89	3463	K	30	27	61,76		I							
4.2 Mod. J73, 81 Eng. 1HZ			90		3463	K	30	27	61,76		I							
4.2 Mod. J80, 81 Eng. 1HZ, 1HDT			10-89		3464	K	30	24	57		I							
4.2 FWD M.T. Mod. FJ, HJ62 Eng. 3F			01-84	12-86	3463	K	30	27	61,76		I							
STARLET																		
1.0 EP 80 (M.T.)			01-90		3428	K	23	21	56		I							
1.0 EP70 (M.T.) 2E-TELU			01-86	12-89	3218	K	23	23	56		I							
1.0 EP70 ABS (M.T.)			90		3439	K	23	23	56	48	I							
1.3 EP71 (M.T.) 2S-ELU			01-84	12-89	3218	K	23	23	56		I							
1.3 EP71 ABS (M.T.)			90		3439	K	23	23	56	48	I							
1.3 EP82 4E-FTE			01-89		3049	K	26	23	56		I							
1.5 NP70 (M.T.) 1N			01-84	12-89	3218	K	23	23	56		I							
1.5 NP70 ABS (M.T.)			90		3439	K	23	23	56	48	I							
1.5 NP80 (A.T./M.T.) 1N 1500 DLS			01-89		3218	K	23	23	56		I							
1.5 NP80 ABS (A.T./M.T.)			90		3439	K	23	23	56	48	I							
TERCEL																		
1,3			01-91	12-94	3429	K	26	22	56		I							
1.3 ABS			01-91	12-94	3430	K	26	22	56	48	I							
1.3 AL11 Eng. 2A			01-80	12-81	3049	K	26	23	56		I							
1.3 AL20 Eng. 2A			08-82	03-85	3049	K	26	23	56		I							
1.5 AL25 4WD Eng. 3A (front.)			01-83	04-88	3049	K	26	23	56		I							
1.5 Mod. (Usa)			01-87	12-90	3049	K	26	23	56		I							
1.5 Mod. (Usa)			01-91		3296	K	26	23	56		I							
			94		3449	K	26	22	56		I							



CHASSIS →

→ CHASSIS



G L O N .

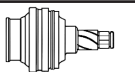
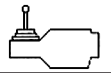

XXXX	K	A	B	C	ABS	P	XXXX	K	A	B	C
------	---	---	---	---	-----	---	------	---	---	---	---



VALENTINI

JADIM SMILE					3115	K	18	18	42		E	4015	K	18	18	62

VAUXHALL

ASTRA (A.T.)																
1,3	44/55 kW (60-75 HP)		08-84	12-91	3039	K	22	22	52		E					
1,6	55 kW (75 HP)		08-84	12-91	3039	K	22	22	52		E					
1.6 ABS	55 kW (75 HP)		08-84	12-92	3126	K	22	22	52	29	E					
1.7 DIESELABS	42 kW (57 HP)		08-91	12-92	3100	K	33	25	52	29	E					
1.7 TURBO DIESELABS	60 kW (82 HP)		08-91		3100	K	33	25	52	29	E					
1.8 ABS	66 kW (90 HP)		08-91		3100	K	33	25	52	29	E					
2.0 ABS	85 kW (115 HP)		08-91		3100	K	33	25	52	29	E					
ASTRA (M.T.)																
1.0	29/37 kW (40-50 HP)		08-79	12-81								4039	K	22	22	84
1.0	29/37 kW (40-50 HP)		01-81	07-84	3039	K	22	22	52		E	4039	K	22	22	84
1,2	39/44 kW (53-60 HP)		08-79	12-81								4039	K	22	22	84
1,2	39/44 kW (53-60 HP)		01-81	12-91	3039	K	22	22	52		E	4039	K	22	22	84
1.2 ABS	40 kW (55 HP)		09-84	12-91	3126	K	22	22	52	29	E	4039	K	22	22	84
1,3	44/55 kW (60-75 HP)		08-79	12-81								4039	K	22	22	84
1,3	44/55 kW (60-75 HP)		01-81	12-91	3039	K	22	22	52		E	4039	K	22	22	84
1.3 ABS	44/55 kW (60-75 HP)		09-84	12-91	3126	K	22	22	52	29	E	4039	K	22	22	84
1,4	44 kW (60 HP)		01-90	12-91	3039	K	22	22	52		E	4039	K	22	22	84
1.4 ABS	44/60 kW (60-82 HP)		08-91	12-92	3126	K	22	22	52	29	E	4039	K	22	22	84
1.4 ABS	44/60 kW (60-82 HP)		01-94		3360	K	22	22	52	29	E					
1,6	55 kW (75 HP)		01-81	12-91	3039	K	22	22	52		E	4039	K	22	22	84
1.6S	66 kW (90 HP)		08-81	07-84	3538	K	33	25	52		E	4038	K	34	22	84
1.6S & DIESEL	39 kW (54 HP)		08-84	12-91	3538	K	33	25	52		E	4038	K	34	22	84
1.6 DIESELABS	40 kW (54 HP)		08-84	12-91	3100	K	33	25	52	29	E					
1.6 ABS	52/55/74 kW (71-75-101 HP)		09-84	12-92	3126	K	22	22	52	29	E	4039	K	22	22	84
1.6 ABS	55/74 kW (75/101HP)		01-94		3360	K	22	22	52	29	E					
1.7 DIESEL	42 kW (57 HP)		08-84	12-91	3538	K	33	25	52		E					
1.7 DIESELABS	42 kW (57 HP)		08-91		3100	K	33	25	52	29	E	4039	K	22	22	84
1.7 DIESELABS	42 kW (57 HP)		01-94		3360	K	22	22	52	29	E					
1.7 TURBO DIESELABS	60 kW (82 HP)		08-91		3100	K	33	25	52	29	E					
1,8	82/85 kW (112-115 HP)		01-81	12-91	3538	K	33	25	52		E					
1.8 & DIESEL			08-81	07-84	3538	K	33	25	52		E					
1.8 ABS	82/85 kW (112-115 HP)		08-84	12-91	3100	K	33	25	52	29	E					
1.8 ABS	66 kW (90 HP)		08-91		3100	K	33	25	52	29	E					



		CHASSIS →	→ CHASSIS		G L O N .												
					XXXX	K	A	B	C	ABS	P	XXXX	K	A	B	C	
VAUXHALL																	
2.0	85 kW (115 HP)			08-84	12-91	3538	K	33	25	52		E					
2.0 16V	110kW (150 HP)			08-84	12-91	3538	K	33	25	52		E					
2.0 16V ABS	110kW (150 HP)			08-84	12-91	3100	K	33	25	52	29	E					
2.0 ABS	85/110 kW (115-150 HP)			08-84		3100	K	33	25	52	29	E					
ASTRA G																	
1.2 16V	Eng. X12XE 48 kW (65 HP)			09-98		3480	K	33	28	52		E					
1.4 16V	Eng. X14XE 66 kW (90 HP)			09-98		3476	K	33	22	52		E					
1.6 16V	Eng. X16XEL 74 kW (101 HP)			09-98		3476	K	33	22	52		E					
1.7 TURBO DIESEL	Eng. X17DTL 60 kW (82 HP)			09-98		3476	K	33	22	52		E					
1.8 16V	Eng. X18XE1 85 kW (115 HP)			09-98		3478	K	33	25	52		E					
2.0 16V	Eng. X20XEV 100 kW (136 HP)			09-98		3478	K	33	25	52		E					
2.0 Di	Eng. X20DTL 60 kW (82 HP)			09-98		3478	K	33	25	52		E					
BELMONT																	
1.0	29/37 kW (39-50 HP)			09-84		3039	K	22	22	52		E	4039	K	22	22	84
1,2	40 kW (54 HP)			09-84		3039	K	22	22	52		E	4039	K	22	22	84
1,3	44/55 kW (60-75 HP)			09-84		3039	K	22	22	52		E	4039	K	22	22	84
1,6	55 kW (75 HP)			08-81		3538	K	33	25	52		E	4038	K	34	22	84
1.6 DIESEL	40 kW (54 HP)			08-81	07-84	3538	K	33	25	52		E					
1,8	66/84 kW (90-115 HP)			08-81		3538	K	33	25	52		E					
1.8 DIESEL	64 kW (88 HP)			08-81	07-84	3538	K	33	25	52		E					
CALIBRA A.T.																	
2.0i ABS				09-89	07-91	3127	K	33	25	52	43	E					
2.0i ABS				08-91		3100	K	33	25	52	29	E					
CALIBRA M.T.																	
2.0 16V ABS				09-89	07-91	3127	K	33	25	52	43	E					
2.0 16V ABS				08-91		3100	K	33	25	52	29	E					
2.0i ABS				09-89	07-91	3127	K	33	25	52	43	E					
2.0i ABS				08-91		3100	K	33	25	52	29	E					
CALIBRA 4WD																	
TT ABS				09-89	07-91	3127	K	33	25	52	43	E					
TT ABS				08-91		3100	K	33	25	52	29	E					
CARLTON																	
2.0 SW (A.T. - M.T.)	74/90 kW (101-123 HP)			08-86	03-94	4052	K		33	100							
2.3 TURBO DIESEL (A.T. - M.T.)	74 kW (101 HP)			08-86	03-94	4052	K		33	100							
2.3 TURBO DIESEL SW (A.T. - M.T.)	74 kW (101 HP)			08-86	03-94	4052	K		33	100							
2.4 - 2.4 SW (A.T. - M.T.)	92 kW (125 HP)			08-86	03-94	4052	K		33	100							
2.6 (A.T. - M.T.)	110 kW (150 HP)			08-86	03-94	4052	K		33	100							
3.0 - 3.0SW (A.T. - M.T.)	130/150 kW (177-204 HP)			08-86	03-94	4052	K		33	100							
CARLTON																	
2.0, i SW (ABS or NO ABS)	74/85/90 kW (101-115-122 HP)			08-86	03-94	4501	K		28	108							
2.3 TD, SW (A.T./M.T.)	66/74 kW (90-101 HP)			08-86	03-94	4501	K		28	108							
2.4, SW (ABS or NO ABS)	92 kW (125 HP)			08-86	03-94	4501	K		28	108							
2.6i (ABS or NO ABS) A.T./M.T.	110 kW (149 HP)			09-90	03-94	4501	K		28	108							
3.0, 24V, SW (ABS or NO ABS) A.T./M.T.	115/130/147/150 kW (156-177-200-204 HP)			08-86	03-94	4501	K		28	108							
CAVALIER (A.T.)																	
1.6 ABS	55 kW (75 HP)			10-88	07-91	3118	K	22	22	52	43	E					



CHASSIS →

→ CHASSIS



G L O N .

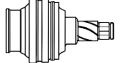
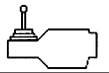

XXXX	K	A	B	C	ABS	P	XXXX	K	A	B	C
------	---	---	---	---	-----	---	------	---	---	---	---

VAUXHALL

1.6 ABS	55 kW (75 HP)			08-91	12-93	3126	K	22	22	52	29	E					
1.7 DIESEL ABS	42 kW (57 HP)			10-88	07-91	3127	K	33	25	52	43	E					
1.7 DIESEL ABS	42 kW (57 HP)			08-91	12-93	3100	K	33	25	52	29	E					
1.7 TURBO DIESEL ABS	60 kW (82 HP)			08-91	12-93	3100	K	33	25	52	29	E					
1.8 ABS	66 kW (90 HP)			10-88	07-91	3127	K	33	25	52	43	E					
1.8 ABS	66 kW (90 HP)			08-91	12-93	3100	K	33	25	52	29	E					
2.0 ABS	85 kW (115 HP)			10-88	07-91	3127	K	33	25	52	43	E					
2.0 ABS	85 kW (115 HP)			08-91		3100	K	33	25	52	29	E					
CAVALIER (M.T.)																	
1.3	50/55 kW (68-75 HP)			08-81	10-88	3039	K	22	22	52		E	4039	K	22	22	84
1.4 ABS	44/60 kW (60-82 HP)			10-88	07-91	3118	K	22	22	52	43	E	4039	K	22	22	84
1.4 ABS	44/60 kW (60-82 HP)			08-91	12-93	3126	K	22	22	52	29	E	4039	K	22	22	84
1.6	55 kW (75 HP)			08-81	10-88	3039	K	22	22	52		E	4039	K	22	22	84
1.6 ABS	55/74 kW (75-100 HP)			10-88	07-91	3118	K	22	22	52	43	E	4039	K	22	22	84
1.6 ABS	55/74 kW (75-100 HP)			08-91	12-93	3126	K	22	22	52	29	E	4039	K	22	22	84
1.6 DIESEL	55 kW (75 HP)			08-81	10-88	3538	K	33	25	52		E	4038	K	34	22	84
1.6S	66 kW (90 HP)			08-81	10-88	3538	K	33	25	52		E	4038	K	34	22	84
1.7 DIESEL ABS	42 kW (57 HP)			10-88	07-91	3127	K	33	25	52	43	E	4039	K	22	22	84
1.7 DIESEL ABS	42 kW (57 HP)			08-91	12-93	3100	K	33	25	52	29	E	4039	K	22	22	84
1.7 TURBO DIESEL ABS	60 kW (82 HP)			03-90	07-91	3127	K	33	25	52	43	E					
1.7 TURBO DIESEL ABS	60 kW (82 HP)			08-91	12-93	3100	K	33	25	52	29	E					
1.8	85 kW (115 HP)			08-82	10-88	3538	K	33	25	52		E					
1.8 ABS	66 kW (90 HP)			10-88	07-91	3127	K	33	25	52	43	E					
1.8 ABS	66 kW (90 HP)			08-91	12-93	3100	K	33	25	52	29	E					
2.0	73/85/95 kW (100-115-130 HP)			08-82	10-88	3538	K	33	25	52		E					
2.0 ABS	85 kW (115 HP)			10-88	07-91	3127	K	33	25	52	43	E					
2.0 ABS	85 kW (115 HP)			08-91	12-93	3100	K	33	25	52	29	E					
2.0 GSI 16V ABS	100/110 kW (136-150 HP)			09-89	07-91	3127	K	33	25	52	43	E					
2.0 GSI 16V ABS	100/110 kW (136-150 HP)			08-91	12-93	3100	K	33	25	52	29	E					
CAVALIER 4WD																	
2.0 ABS	85/110 kW (115-150 HP)	L5000001	M5999999	09-89	07-91	3127	K	33	25	52	43	E					
2.0 ABS	85/110 kW (115-150 HP)	N5000001	P-52719 48	08-91	12-93	3100	K	33	25	52	29	E					
MONZA (A.T./M.T.)																	
3.0 (ABS or NO ABS)	115 kW (156 HP)			09-85	87	4501	K		28	108							
NOVA A																	
1.0	33 kW (45 HP)			09-82	12-93	3068	K	22	28	51,8		E					
1,2	33/45 kW (45-55 HP)			09-82	12-93	3068	K	22	28	51,8		E					
1,3	51 kW (70 HP)			09-82	12-93	3068	K	22	28	51,8		E					
1,4	44/60 kW (60-82 HP)			09-82	12-93	3068	K	22	28	51,8		E					
1.5 DIESEL	37 kW (50 HP)			09-87	12-93	3068	K	22	28	51,8		E					
1.5 TURBO DIESEL	49 kW (67 HP)			09-87	12-93	3039	K	22	22	52		E	4039	K	22	22	84
1,6	72/74 kW (98-101 HP)			09-87	12-93	3039	K	22	22	52		E	4039	K	22	22	84
NOVA B																	
1.2 ABS	33/45 kW (45-55 HP)			01-94		3359	K	22	28	52	29	E					
1.4 ABS	44/66 kW (60-90 HP)			01-94		3359	K	22	28	52	29	E					
1.6 ABS	72/74 kW (98-101 HP)			01-94		3360	K	22	22	52	29	E					



	CHASSIS →	→ CHASSIS		G L O N .											
				XXXX	K	A	B	C	ABS	P	XXXX	K	A	B	C

VAUXHALL

ROYAL (A.T./M.T.)															
3.0 (ABS or NO ABS)	115 kW (156 HP)		09-85	87	4501	K		28	108						
3.0 24V	115/130/150 kW (156-177-204 HP)		87	93	4501	K		28	108						
SENATOR															
2.5 (A.T./M.T.)	103 kW (140 HP)		09-87	06-93	4052	K		33	100						
3.0 (A.T./M.T.)	114/130 kW (156-177 HP)		09-87	06-93	4052	K		33	100						
VECTRA															
1.7 TURBO DIESEL ABS	60 kW (82 HP)		10-95		3479	K	33	25	52	29	E				
1.8i 16V ABS	85 kW (115 HP)		10-95		3479	K	33	25	52	29	E				
2.0 Di ABS	60 kW (82 HP)		11-96		3479	K	33	25	52	29	E				
2.0i 16V ABS	100 kW (136 HP)		10-95		3479	K	33	25	52	29	E				
2.5i V6 ABS	125 kW (170 HP)		10-95		3479	K	33	25	52	29	E				
ZAFIRA															
1.6 16V	Eng. X16XEL 74 kW (101 HP)		04-99		3478	K	33	25	52		E				
1.6 16V ABS	Eng. X16XEL 74 kW (101 HP)		04-99		3479	K	33	25	52	29	E				
1.8 16V	Eng. X18XE1 85 kW (115 HP)		04-99		3478	K	33	25	52		E				
1.8 16V ABS	Eng. X18XE1 85 kW (115 HP)		04-99		3479	K	33	25	52	29	E				
2.0 16V	Eng. X20XEV 100 kW (136 HP)		09-98		3478	K	33	25	52		E				
2.0 16V ABS	Eng. X20XEV 100 kW (136 HP)		09-98		3479	K	33	25	52	29	E				
2.0 Di	Eng. X20DTL 60 kW (82 HP)		09-99		3478	K	33	25	52		E				
2.0 Di ABS	Eng. X20DTL 60 kW (82 HP)		09-99		3479	K	33	25	52	29	E				

VOLKSWAGEN (BRAZIL)

GOL															
1.8L			11-82	10-94	3548	K	22	30	51		I				
1000 - AE 1.0L			10-92		3548	K	22	30	51		I				
AE 1.6			11-89	10-94	3548	K	22	30	51		I				
AP 1.6L			06-93	10-94	3548	K	22	30	51		I				
AP 2.0L EFI			12-88	10-94	3548	K	22	30	51		I				
MOT. AIR REFRIG.			05-80	08-86	3505	K	22	30	51		E				
TT			11-82	12-86	3505	K	22	30	51		E				
TT			12-86	10-89	3548	K	22	30	51		I				
KOMBI															
GASOL - ALCOOL - DIESEL			02-78		4334	K		33	100			4334	K		33 100
PARATI															
AE 1.6L			11-89		3548	K	22	30	51		I				
AP 1.8L			08-81		3548	K	22	30	51		I				



	CHASSIS ↑	→ CHASSIS		G L O N .											
				XXXX	K	A	B	C	ABS	P	XXXX	K	A	B	C

VOLKSWAGEN (BRAZIL)

TT			08-81	08-86	3505	K	22	30	51		E				
TT			09-86	10-89	3548	K	22	30	51		I				
PASSAT															
1.5			09-75	08-86	3505	K	22	30	51		E				
1.6L			09-75	08-86	3505	K	22	30	51		E				
1.6L			09-86	12-88	3548	K	22	30	51		I				
1.8L			09-75	12-88	3548	K	22	30	51		I				
QUANTUM (M.T.)															
DX - SX			03-85	11-92	3548	K	22	30	51		I				
SAVEIRO															
AE 1.6L			11-89		3548	K	22	30	51		I				
AP 1.6L			04-93		3548	K	22	30	51		I				
AP 1.8L			11-89		3548	K	22	30	51		I				
MOT. AIR REFRIG.			05-80	08-86	3505	K	22	30	51		E				
TT			08-86	10-89	3548	K	22	30	51		I				
TT			11-82	08-86	3505	K	22	30	51		E				
VARIANT II															
TT			01-77	12-80	4334	K		33	100			4334	K		33 100
VOYAGE															
AE 1.6L			11-89		3548	K	22	30	51		I				
AP 1.6L			06-93		3548	K	22	30	51		I				
AP 1.8L			08-81		3548	K	22	30	51		I				
TT			08-81	08-86	3505	K	22	30	51		E				
TT			09-86	10-89	3548	K	22	30	51		I				

VOLKSWAGEN

411 (A.T.)																
TT			419 100 000	01-68	07-69	4511	K		33	94			4511	K		33 94
1302																
TT				08-70	08-72	4511	K		33	94			4511	K		33 94
1303																
TT				08-72	07-75	4511	K		33	94			4511	K		33 94
1600 (A.T.)																
1600	318 015 226	3 132 500 000		10-67	08-73	4511	K		33	94			4511	K		33 94
1600 (M.T.)																
1600	319 000 001	3 132 500 000		08-68	08-73	4511	K		33	94			4511	K		33 94
L - T - LT - VARIANT	319 000 001	3 132 500 000		08-68	08-73	4511	K		33	94			4511	K		33 94



	CHASSIS →	→ CHASSIS		G L O N .										
				XXXX	K	A	B	C	ABS	P	XXXX	K	A	B

VOLKSWAGEN

						XXXX	K	A	B	C	ABS	P	XXXX	K	A	B	C
BEETLE																	
1302						4511	K		33	94			4511	K		33	94
1303						4511	K		33	94			4511	K		33	94
CADDY (M.T.)																	
1.5	40/70 kW (54-95 HP)	14-D-000 062	14-N-010 000	10-82	07-92	3548	K	22	30	51		I	4511	K		33	94
1.8	40/70 kW (54-95 HP)	14-D-000 062	14-N-010 000	10-82	07-92	3548	K	22	30	51		I	4511	K		33	94
CARAT																	
TT				01-84		3548	K	22	30	51		I	4511	K		33	94
CORRADO (M.T.)																	
1.8	118 kW (160 HP)	50-K-006 794	50-R-002 000	01-89	09-93	3547	K	22	30	51		I					
2.0	100 kW (136 HP)	50-N-000 001		08-91		3547	K	22	30	51		I					
DASHER (A.T.)																	
TT				01-74	12-80	3505	K	22	30	51		E	4511	K		33	94
TT				01-81	12-81	3548	K	22	30	51		I	4511	K		33	94
DASHER (M.T.)																	
TT				01-74	12-80	3505	K	22	30	51		E	4511	K		33	94
TT				01-81	12-81	3548	K	22	30	51		I	4511	K		33	94
DERBY																	
TT						3089	K	20	25	45,5		I	4005	K		33	91,8
FOX																	
TT				01-87		3548	K	22	30	51		I	4511	K		33	94
FOX WAGON																	
TT				01-87		3548	K	22	30	51		I	4511	K		33	94
GOLF IV																	
1.4 A.T.	Mod. 1J 55 kW (75 HP)			08-97		3340	K	36	30	53		I	4511	K		33	94
1.4 M.T.	Mod. 1J 55 kW (75 HP)			08-97		3432	K	36	30	53		I	4511	K		33	94
1.6 A.T.	Mod. 1J 74 kW (101 HP)			08-97		3340	K	36	30	53		I	4511	K		33	94
1.6 M.T.	Mod. 1J 74 kW (101 HP)			08-97		3432	K	36	30	53		I	4511	K		33	94
1.8 A.T.	Mod. 1J 92 kW (125 HP)			08-97									4511	K		33	94
1.8 M.T.	Mod. 1J 92 kW (125 HP)			08-97		3340	K	36	30	53		I					
1.9 SDi M.T.	Mod. 1J 50 kW (68 HP)			08-97		3432	K	36	30	53		I	4511	K		33	94
GOLF - JETTA LIMOUSINE (A.T.)																	
1.5	48/51 kW (65-70 HP)	175 3000 001	17-A-0116 212	04-74	09-79	3505	K	22	30	51		E	4511	K		33	94
1.5	48/51 kW (65-70 HP)	17-A-0116 213	17-D-641 909	10-79	07-83	3548	K	22	30	51		I	4511	K		33	94
1.6	51/55 kW (79-75 HP)	175 3000 001	17-A-0116 212	04-74	09-79	3505	K	22	30	51		E	4511	K		33	94
1.6	51/55 kW (79-75 HP)	17-A-0116 213	1G-N-158 228	10-79	10-91	3548	K	22	30	51		I	4511	K		33	94
1.6	74 kW (100 HP)	1H-S-000 001		07-94		3547	K	22	30	51		I					
1.8	62/66 kW (84-90 HP)	17-D-641 910	1G-N-158 228	08-83	10-91	3548	K	22	30	51		I	4511	K		33	94
1.8	66 kW (90 HP)	1H-N-000 001	1H-R-990 000	11-91	07-94	3547	K	22	30	51		I	4048	K		33	100
1.8	55/66 kW (79-90 HP)	1H-S-000 001		07-94		3547	K	22	30	51		I					
2.0	85 kW (115 HP)	1H-N-105 002	1H-R-990 000	01-92	07-94	3547	K	22	30	51		I	4048	K		33	100
2.0	79/85 kW (107-115 HP)	1H-S-000 001		07-94		3547	K	22	30	51		I					
GOLF - JETTA LIMOUSINE (M.T.)																	
1.05	33 kW (45 HP)	17-D-641910	1G-N-158228	08-83	10-91	3548	K	22	30	51		I	4005	K		33	91,8
1.1	37 kW (50 HP)	175 3000 001	17-A-0360000	04-74	02-80	3505	K	22	30	51		E	4005	K		33	91,8
1.1	37 kW (50 HP)	17-A-0360001	17-D-641909	02-80	07-83	3548	K	22	30	51		I	4005	K		33	91,8



CHASSIS ↑

→ CHASSIS

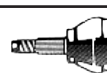
**G L O N .**

XXXX	K	A	B	C	ABS	P	XXXX	K	A	B	C
------	---	---	---	---	-----	---	------	---	---	---	---

VOLKSWAGEN

1.3	44 kW (60 HP)	175 3000 001	17-A-0360000	04-74	02-80	3505	K	22	30	51		E	4005	K		33	91,8
1.3	37/44 kW (50-60 HP)	17-A-0360001	1G-N-158228	02-80	07-92	3548	K	22	30	51		I	4005	K		33	91,8
1.3i.	40 kW (55 HP)	19-H-606 005	1G-N-300 000	02-87	07-92	3548	K	22	30	51		I	4005	K		33	91,8
1.4	44 kW (60 HP)	1H-P-000 001	1H-N-990 000	11-91	07-97	3548	K	22	30	51		I	4005	K		33	91,8
1.4	55kW (75 HP)			08-97		3432	K	36	30	53		I					
1.5	48/51 kW (65-70 HP)	175 3000 001	17-A-0360 000	04-74	02-80	3505	K	22	30	51		E	4511	K		33	94
1.5	48/51 kW (65-70 HP)	17-A-0116 213	17-D-641 909	02-80	07-83	3548	K	22	30	51		I	4511	K		33	94
1.6	51/55 kW (70-75 HP)	175 3000 001	17-A-0360 000	04-74	02-80	3505	K	22	30	51		E	4511	K		33	94
1.6	51/55 kW (70-75 HP)	17-A-0360 001	1G-N-300 000	02-80	07-92	3548	K	22	30	51		I	4511	K		33	94
1.6	55 kW (75 HP)	1H-P-160 001	1H-S-180 000	09-92	09-94	3548	K	22	30	51		I	4005	K		33	91,8
1.6	55/74 kW (75-100 HP)	1H-S-180 001		10-94	07-97	3548	K	22	30	51		I	4511	K		33	94
1.6	74kW (100 HP)			08-97		3432	K	36	30	53		I					
1.6 GTi	81 kW (110 HP)	176 3379 207	17-A-0360 000	06-76	02-80	3505	K	22	30	51		E	4511	K		33	94
1.6 GTi	81 kW (110 HP)	17-A-0360 001	17-C-999 999	02-80	07-82	3547	K	22	30	51		I	4511	K		33	94
1.8	62/66 kW (84-90 HP)	19E-431 737	1G-N-158 228	01-84	10-91	3548	K	22	30	51		I	4511	K		33	94
1.8	55 kW (75 HP)	1H-N-000 001		11-91		3547	K	22	30	51		I	4048	K		33	100
1.8	66 kW (90 HP)	1H-N-000 001		11-91		3547	K	22	30	51		I	4048	K		33	100
1.8 GTi	82 kW (112 HP)	17-D-000 001	17-D-641 909	08-82	07-83	3547	K	22	30	51		I	4511	K		33	94
1.8 GTi	79/82 kW (107-112 HP)	19E-431 737	1G-N-158 228	01-84	10-91	3547	K	22	30	51		I	4048	K		33	100
1.8 GTi 16V	95/102 kW (129-139 HP)	19-G-506 003	1G-N-158 228	02-86	10-91	3547	K	22	30	51		I					
2.0 GTi	85 kW (115 HP)	1H-N-105 002	1H-R-990 000	11-91	07-94	3340	K	36	30	53		I	4048	K		33	100
2.0 GTi 16V	110 kW (150 HP)	1H-P-000 001	1H-R-990 000	08-92	07-94	3340	K	36	30	53		I					
2.8 VR6	128 kW (175 HP)	1H-N-105 002		01-92		3340	K	36	30	53		I					
GOLF - JETTA LIMOUSINE DIESEL (A. T.)																	
1.9 TURBO DIESEL	55 kW (75 HP)	1H-N-000 001	1H-R-990 000	11-91	07-94	3547	K	22	30	51		I	4048	K		33	100
1.9 TURBO DIESEL	55 kW (75 HP)	1H-S-000 001		07-94		3547	K	22	30	51		I					
GOLF - JETTA LIMOUSINE DIESEL (M.T.)																	
1.5	37/40 kW (50-54 HP)	17-A-0116 213	17-D-641 909	10-79	07-83	3548	K	22	30	51		I	4511	K		33	94
1.5 D	37 kW (50 HP)	175 3000 001	17-A-0116 212	08-76	09-79	3505	K	22	30	51		E	4511	K		33	94
1.6 D	40 kW (54 HP)	175 3000 001	17-A-0116 212	08-76	09-79	3505	K	22	30	51		E	4511	K		33	94
1.6 D	37/40 kW (50-54 HP)	17-A-0116 213	1G-N-158 228	10-79	10-91	3548	K	22	30	51		I	4511	K		33	94
1.6 TURBO DIESEL	51 kW (70 HP)	17-D-641 909	1G-N-158 228	03-82	10-91	3548	K	22	30	51		I	4511	K		33	94
1.9 D	48 kW (65 HP)	1H-N-000 001		11-91	07-97	3548	K	22	30	51		I	4511	K		33	94
1.9 D	50 kW (70 HP)			08-97		3432	K	36	30	53		I					
1.9 TURBO DIESEL	55 kW (75 HP)	1H-N-000 001		11-91	9-93	3547	K	22	30	51		I	4048	K		33	100
1.9i. TURBO DIESEL	66 kW (90 HP)	1H-R-080 001		09-93		3547	K	22	30	51		I					
GOLF CABRIO (M.T.)																	
1.3	44 kW (60 HP)	159 2800 001	15-A-0807 000	02-79	02-80	3505	K	22	30	51		E	4005	K		33	91,8
1.3	44 kW (60 HP)	15-A-0807 001	15-E-006 506	02-80	09-83	3548	K	22	30	51		I	4005	K		33	91,8
1.3	40 kW (55 HP)	15-E-006 507	15-G-035 000	10-83	07-86	3548	K	22	30	51		I	4005	K		33	91,8
1.5	51 kW (70 HP)	159 2800 001	15-A-0807 000	02-79	02-80	3505	K	22	30	51		E	4511	K		33	94
1.5	51 kW (70 HP)	15-A-0807 001	15-D-050 000	02-80	07-83	3548	K	22	30	51		I	4511	K		33	94
1.6	51/55 kW (70-75 HP)	159 2800 001	15-A-0807 000	02-79	02-80	3505	K	22	30	51		E	4511	K		33	94
1.6	51/55 kW (70-75 HP)	15-A-0807 001	15-E-006 506	02-80	09-83	3548	K	22	30	51		I	4511	K		33	94
1.6	53/55 kW (72-75 HP)	15-E-006 507	15-J-001 799	10-83	08-87	3548	K	22	30	51		I	4511	K		33	94
1.6	53/55 kW (72-75 HP)	15-J-001 800	15-P-011 965	08-87	12-92	3547	K	22	30	51		I	4048	K		33	100



	CHASSIS →	→ CHASSIS		G L O N .										
				XXXX	K	A	B	C	ABS	P	XXXX	K	A	B

VOLKSWAGEN

1.6 GLi	81 kW (110 HP)	159 2800 001	15-A-0807 000	02-79	02-80	3505	K	22	30	51		E	4511	K		33	94	
1.6 GLi	81 kW (110 HP)	15-A-0807 001	15-E-006 506	02-80	09-83	3548	K	22	30	51		I	4511	K		33	94	
1.8	66/70 kW (90-95 HP)	15-E-000 001	15-J-001 799	08-83	08-87	3548	K	22	30	51		I	4511	K		33	94	
1.8	55/66 kW (75-90 HP)	1E-R-000 001		09-83		3547	K	22	30	51		I	4048	K		33	100	
1.8	66/72 kW (90-98 HP)	15-J-001 800	15-P-040 000	08-87	07-93	3547	K	22	30	51		I	4048	K		33	100	
1.8 GLi, GTi	82 kW (112 HP)	15-F-000 001	15-E-035 000	08-83	07-84	3548	K	22	30	51		I	4511	K		33	94	
1.8 GTi, GTi	82 kW (112 HP)	15-F-000 001	15-N-040 000	08-84	07-92	3547	K	22	30	51		I	4048	K		33	100	
2.0	85 kW (115 HP)	1E-R-000 001		09-93		3547	K	22	30	51		I	4048	K		33	100	
GOLF CABRIO (A.T.)																		
1.6	51/55 kW (70-75 HP)	159 2800 001	15-A-0807 000	02-79	02-80	3505	K	22	30	51		E	4511	K		33	94	
1.6	51/55 kW (70-75 HP)	15-A-0807 001	15-P-040 000	02-80	07-93	3548	K	22	30	51		I	4511	K		33	94	
1.8	66 kW (90 HP)	1E-R-000 001		09-83		3547	K	22	30	51		I	4048	K		33	100	
1.8	66/72 kW (90-98 HP)	15-E-006-507	15-P-040 000	10-83	07-93	3548	K	22	30	51		I	4511	K		33	94	
2.0	85 kW (115 HP)	1E-R-000 001		09-83		3547	K	22	30	51		I	4048	K		33	100	
GOLF - JETTA SYNCRO FWD (M.T.)																		
1.8	62/72 kW (84-98 HP)	19-G-000 001	1G-K-990 000	08-85	07-89	3548	K	22	30	51		I	4511	K		33	94	
1.8	62/72 kW (84-98 HP)	1G-L-000 001	1G-M-990 000	08-89	07-91	3547	K	22	30	51		I	4048	K		33	100	
1.8	66 kW (90 HP)	1H-P-000 001		01-93		3547	K	22	30	51		I	4048	K		33	100	
GOLF - JETTA SYNCRO RWD (M.T.)																		
1.8	62/72 kW (84-98 HP)	19-G-000 001	1G-M-990 000	08-85	07-91	3548	K	22	30	51		I	4511	K		33	94	
1.8	66 kW (90 HP)	1H-P-000 001		01-93									4511	K		33	94	
1.8 ABS	62/72 kW (84-98 HP)	19-G-000 001	1G-M-990 000	08-85	07-91								4511	K		33	94	
GOLF VARIANT (A.T.)																		
1.6	74 kW (100 HP)	1H-S-000 001		07-94		3547	K	22	30	51		I						
1.8	66 kW (90 HP)	1H-N-105 002	1H-R-990 000	01-92	07-94	3547	K	22	30	51		I	4048	K		33	100	
1.8	55/66 kW (75-90 HP)	1H-S-000 001		07-94		3547	K	22	30	51		I						
2.0	85 kW (115 HP)	1H-N-105 002	1H-R-990 000	01-92	07-94	3547	K	22	30	51		I	4048	K		33	100	
2.0	79/85 kW (107-115 HP)	1H-S-000 001		07-94		3547	K	22	30	51		I						
GOLF VARIANT (M.T.)																		
1.4	44 kW (60 HP)	1H-N-105 002		01-92		3548	K	22	30	51		I	4005	K		33	91,8	
1.6	55 kW (75 HP)	1H-P-114 031	1H-S-180 001	09-92	09-94	3548	K	22	30	51		I	4005	K		33	91,8	
1.6	55/74 kW (75-100 HP)	1H-S-180 001		10-94		3548	K	22	30	51		I	4511	K		33	94	
1.8	55 kW (75 HP)	1H-N-105 002		01-92		3547	K	22	30	51		I	4048	K		33	100	
1.8	66 kW (90 HP)	1H-N-105 002		01-92		3547	K	22	30	51		I	4048	K		33	100	
2.0	85 kW (115 HP)	1H-N-105 002	1H-R-990 000	01-92	07-94	3340	K	36	30	53		I	4048	K		33	100	
2.0 16V	110 kW (150 HP)	1H-P-000 001	1H-R-990 000	08-92	07-94	3340	K	36	30	53		I						
2.8 VR6	128 kW (175 HP)	1H-N-105 002		01-92		3340	K	36	30	53		I						
GOLF VARIANT DIESEL (A.T.)																		
1.9 D	55 kW (75 HP)	1H-N-105 002	1H-R-990 000	01-92	07-94	3547	K	22	30	51		I	4048	K		33	100	
1.9 D	55 kW (75 HP)	1H-S-000 001		01-92		3547	K	22	30	51		I						
GOLF VARIANT DIESEL (M.T.)																		
1.9 D	48 kW (65 HP)	1H-N-105 002		01-92		3548	K	22	30	51		I	4511	K		33	94	
1.9 D	55 kW (75 HP)	1H-N-105 002		01-92		3547	K	22	30	51		I	4048	K		33	100	
1.9 TURBO DIESEL	55 kW (75 HP)	1H-R-080 001		09-93		3547	K	22	30	51		I						
ILTIS																		
1,6	51 kW			09-87	12-88	3547	K	22	30	51		I						



CHASSIS ↑

→ CHASSIS

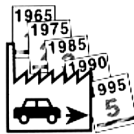
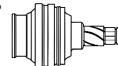
**G L O N .**

XXXX

K

A

B

C

ABS

P

XXXX

K

A

B

C

VOLKSWAGEN

						XXXX	K	A	B	C	ABS	P	XXXX	K	A	B	C
1,7	55 kW			01-79	10-86	3547	K	22	30	51		I					
JETTA (A.T.)																	
1.5			16-A-0360 000	08-79	10-83	3505	K	22	30	51		E	4511	K		33	94
1.5		16-A-0360 001		08-79	10-83	3548	K	22	30	51		I	4511	K		33	94
1.6			16-A-0360 000	08-79	10-83	3505	K	22	30	51		E	4511	K		33	94
1.6		16-A-0360 001		08-79		3548	K	22	30	51		I	4511	K		33	94
JETTA (M.T.)																	
1.1			16-A-0360 000	08-79	10-83	3505	K	22	30	51		E	4005	K		33	91,8
1.1		16-A-0360 001		08-79	10-83	3548	K	22	30	51		I	4005	K		33	91,8
1.3			16-A-0360 000	08-79	10-83	3505	K	22	30	51		E	4005	K		33	91,8
1.3		16-A-0360 001		08-79		3548	K	22	30	51		I	4005	K		33	91,8
1.5			16-A-0360 000	08-79	10-83	3505	K	22	30	51		E	4511	K		33	94
1.5		16-A-0360 001		08-79	10-83	3548	K	22	30	51		I	4511	K		33	94
1.6			16-A-0360 000	08-79	10-83	3505	K	22	30	51		E	4511	K		33	94
1.6		16-A-0360 001		08-79		3548	K	22	30	51		I	4511	K		33	94
1.6 Li - GLi		16-A-0360 001		08-79	10-83								4511	K		33	94
1.8		16-E-0431 736		01-84		3548	K	22	30	51		I	4511	K		33	94
1.8 CLi - GLi		16-E-0431 736		01-84		3547	K	22	30	51		I	4048	K		33	100
JETTA DIESEL																	
TT			16-A-0360 000	08-79	10-83	3505	K	22	30	51		E	4511	K		33	94
TT		16-A-0360 001		08-79		3548	K	22	30	51		I	4511	K		33	94
KARMANN GHIA																	
TT				01-68		4511	K		33	94			4511	K		33	94
PASSAT (A.T.)																	
1.5	55/66 kW (75-90 HP)	324 2000 001	326 2087 472	05-73	12-75	3505	K	22	30	51		E	4511	K		33	94
1.6	53/63 kW (72-85 HP)	326 2000 001	32-A-150 000	09-75	04-80	3505	K	22	30	51		E	4511	K		33	94
1.6	53/63 kW (72-85 HP)	32-A-150 001	32-A-206 720	04-80	11-80	3548	K	22	30	51		I	4511	K		33	94
1.6	53/63 kW (72-85 HP)	32-B-000 001	32-J-299 999	08-80	03-88	3548	K	22	30	51		I	4511	K		33	94
1.8	62/68 kW (84-92 HP)	32-D-099 298	32-J-299 999	01-83	03-88	3548	K	22	30	51		I	4511	K		33	94
1.8	66/82 kW (90-112 HP)	31-J-000 001	31-N-105 278	03-88	10-91	3547	K	22	30	51		I	4048	K		33	100
1.8	100 kW (136 HP)	31-J-000 001	31-N-105 278	04-88	10-91	3547	K	22	30	51		I					
1.8	66 kW (90 HP)	31-N-105 279	31-PE-259 865	10-91	10-93	3547	K	22	30	51		I	4048	K		33	100
1.8	100 kW (136 HP)	31-N-105 279	31-PE-259 865	10-91	10-93	3547	K	22	30	51		I					
1.8	66 kW (90 HP)	3A-RE-001 001		10-93		3547	K	22	30	51		I					
1.8 (AIR COND.)	66/82 kW (90-112 HP)	31-J-000 001	31-M-400 000	03-88	07-91	3547	K	22	30	51		I	4048	K		33	100
1.8 (AIR COND.)	100 kW (136 HP)	31-J-000 001	31-M-300 000	04-88	05-91	3547	K	22	30	51		I					
1.9	85 kW (115 HP)	32-B-040 822	32-D-092 500	01-81	12-82	3548	K	22	30	51		I	4511	K		33	94
1.9	85 kW (115 HP)	32-D-092 501	32-D-300 000	12-82	07-83	3547	K	22	30	51		I	4048	K		33	100
2.0	85 kW (115 HP)	32-E-000 001	32-J-299 999	08-83	03-88	3547	K	22	30	51		I	4048	K		33	100
2.0	100 kW (136 HP)	31-K-000 001	31-N-105 278	08-88	10-91	3547	K	22	30	51		I					
2.0	85 kW (115 HP)	31-L-201 814	31-PE-259 865	03-90	10-93	3547	K	22	30	51		I	4048	K		33	100
2.0	100 kW (136 HP)	31-N-105 279	31-PE-259 865	10-91	10-91	3547	K	22	30	51		I					
2.0	85 kW (115 HP)	3A-RE-001 001		10-93		3547	K	22	30	51		I					
2.2	85 kW (115 HP)	32-B-000 001	32-D-092 500	08-80	12-82	3548	K	22	30	51		I	4511	K		33	94
2.2	85 kW (115 HP)	32-D-092 501	32-J-299 999	12-82	03-88	3547	K	22	30	51		I	4048	K		33	100
2.23	85 kW (115 HP)	32-H-000 001	32-J-299 999	08-86	03-88	3547	K	22	30	51		I	4048	K		33	100



	CHASSIS →	→ CHASSIS		G L O N .									
				XXXX	K	A	B	C	ABS	P	XXXX	K	A

VOLKSWAGEN

2.3	85 kW (115 HP)	32-G-015 540	32-G-400 000	08-85	07-86	3547	K	22	30	51		I	4048	K		33	100	
PASSAT (M.T.)																		
1.3	40/44 kW (54-60 HP)	324 2000 001	32-A-150 000	05-73	04-80	3505	K	22	30	51		E	4511	K		33	94	
1.3	40/44 kW (54-60 HP)	32-A-150 001	32-H-2220 000	08-80	07-87	3548	K	22	30	51		I	4511	K		33	94	
1.5	48/63 kW (65-85 HP)	324 2000 001	326 2087 472	05-73	12-75	3505	K	22	30	51		E	4511	K		33	94	
1.6	51/63 kW (70-85 HP)	324 2000 001	32-A-150 000	05-73	04-80	3505	K	22	30	51		E	4511	K		33	94	
1.6	51/63 kW (70-85 HP)	32-A-150 001	31-L-400 000	04-80	07-90	3548	K	22	30	51		I	4511	K		33	94	
1.6	51/63 kW (70-85 HP)	31-M-000 001		08-90		3547	K	22	30	51		I	4048	K		33	100	
1.6	74 kW (101 HP)	3A-SE-050 001		10-94		3547	K	22	30	51		I	4048	K		33	100	
1.6 (AIR COND.)	55 kW (75 HP)	31-M-000 001	31-N-105 278	08-90	10-91	3547	K	22	30	51		I	4048	K		33	100	
1.8	62/68 kW (85-93 HP)	32-D-099 298	32-J-299 999	01-83	03-88	3548	K	22	30	51		I	4511	K		33	94	
1.8	55/82 kW (75-112 HP)	31-J-000 001		04-88		3547	K	22	30	51		I	4048	K		33	100	
1.8	100 kW (136 HP)	31-J-000 001	31-N-105 278	04-88	10-91	3547	K	22	30	51		I	4048	K		33	100	
1.8	100 kW (136 HP)	31-N-105 279	31-PE-259 865	10-91	10-93	3547	K	22	30	51		I	4048	K		33	100	
1.8 (AIR COND.)	55/66kW (75 HP)	31-J-000 000	31-N-105 278	04-88	10-91	3547	K	22	30	51		I	4048	K		33	100	
1.8 (AIR COND.)	100 kW (136 HP)	31-J-000 001	31-N-105 278	04-88	10-91	3547	K	22	30	51		I	4048	K		33	100	
1.9	85 kW (115 HP)	32-B-040 822	32-D-092 500	01-81	12-82	3548	K	22	30	51		I	4511	K		33	94	
1.9	85 kW (115 HP)	32-D-092 501	32-D-300 000	12-82	07-83	3547	K	22	30	51		I	4048	K		33	100	
1.9 TDi ABS	81 kW (110 HP)			10-96		3280	K	38	27	59,5	45	I						
1.9 TDi ABS	66 kW (90 HP)			10-96		3381	K	33	30	53	45	I						
2.0	85 kW (115 HP)	32-E-000 001	32-J-299 999	08-83	03-88	3548	K	22	30	51		I	4511	K		33	94	
2.0	100 kW (136 HP)	31-K-000 001	31-N-105 278	08-88	10-91	3547	K	22	30	51		I						
2.0	85 kW (115 HP)	31-L-201 814	31-N-105 278	03-90	10-91	3547	K	22	30	51		I						
2.0	85 kW (115 HP)	31-N-105 279		10-91		3547	K	22	30	51		I	4048	K		33	100	
2.0	100 kW (136 HP)	31-N-105 279	31-PE-259 865	10-91	10-93	3547	K	22	30	51		I						
2.0 (AIR COND.)	100 kW (136 HP)	31-K-000 001	31-N-105 278	08-88	10-91	3547	K	22	30	51		I						
2.0 (AIR COND.)	85 kW (115 HP)	31-L-201 815	31-N-105 278	03-90	10-91	3547	K	22	30	51		I	4048	K		33	100	
2.2	85 kW (115 HP)	32-B-040 822	32-D-092 500	01-81	12-82	3548	K	22	30	51		I	4511	K		33	94	
2.2	85 kW (115 HP)	32-D-092 501	32-J-299 999	12-82	03-88	3547	K	22	30	51		I	4048	K		33	100	
2.23	85 kW (115 HP)	32-H-300 001	32-J-299 999	06-86	03-88	3212	K	22	25	51		E	4051	K		28	108	
2.3	100 kW (136 HP)	32-F-000 001	32-J-299 999	08-84	03-88	3212	K	22	25	51		E	4051	K		28	108	
2.3	85 kW (115 HP)	32-G-015 540	32-G-400 000	08-85	07-86	3547	K	22	30	51		I	4048	K		33	100	
PASSAT DIESEL (A.T.)																		
1.6 D	40 kW (54 HP)	32-B-000 001	32-J-299 999	08-80	03-88	3548	K	22	30	51		I	4511	K		33	94	
1.6 TURBO DIESEL	51 kW (70 HP)	32-C-110 981	32-F-500 000	12-81	07-85	3548	K	22	30	51		I	4511	K		33	94	
1.9 D	55 kW (75 HP)	31-N-000 001	31-PE-259 865	08-91	10-93	3547	K	22	30	51		I	4048	K		33	100	
1.9 D	55 kW (75 HP)	3A-RE-000 001		10-93		3547	K	22	30	51		I						
PASSAT DIESEL (M.T.)																		
1.6 D	40 kW (54 HP)	32-B-300 000	32-J-299 999	08-80	03-88	3548	K	22	30	51		I	4511	K		33	94	
1.6 TURBO DIESEL	51 kW (70 HP)	32-C-110 981	32-J-299 999	12-81	03-88	3548	K	22	30	51		I	4511	K		33	94	
1.6 TURBO DIESEL	59 kW (80 HP)	31-J-000 001	31-L-400 000	04-88	07-90	3548	K	22	30	51		I	4511	K		33	94	
1.6 TURBO DIESEL	59 kW (80 HP)	31-M-000 001	31-PE-259 865	08-90	10-93	3547	K	22	30	51		I	4048	K		33	100	
1.6 TURBO DIESEL (AIR COND.)	59 kW (80 HP)	31-M-000 001	31-N-105 278	08-90	10-91	3547	K	22	30	51		I	4048	K		33	100	
1.9 D	49/55 kW (67-75 HP)	31-K-296 658		05-89		3547	K	22	30	51		I	4048	K		33	100	
1.9 D	66 kW (90 HP)	3A-RE-000 001		10-93		3547	K	22	30	51		I						
1.9 D (AIR COND.)	49/55 kW (67-75 HP)	31-K-296 658	31-N-105 278	05-85	10-91	3547	K	22	30	51		I	4048	K		33	100	



CHASSIS ↑

→ CHASSIS

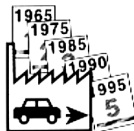
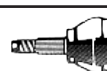
**G L O N .**

XXXX K A B C ABS P XXXX K A B C

VOLKSWAGEN

PASSAT SYNCRO 4WD (M.T.)																		
TT		33-F-000 001	33-H-086 636	08-84	12-86	3548	K	22	30	51		I						
PASSAT SYNCRO FWD (M.T.)																		
1.8	66/100 kW (90-136 HP)	33-F-000 001	33-J-299 999	04-84	07-88	3547	K	22	30	51		I	4048	K		33	100	
2.23	66/100 kW (90-136 HP)	33-F-000 001	33-J-299 999	04-84	07-88	3547	K	22	30	51		I	4048	K		33	100	
PASSAT SYNCRO RWD (M.T.)																		
1.8	66/100 kW (90-136 HP)	33-F-000 001	33-J-299 999	04-84	12-86	3548	K	22	30	51		I	4511	K		33	94	
1.8	66/100 kW (90-136 HP)	33-H-086 637	33-J-299 999	01-87	07-88	3547	K	22	30	51		I	4048	K		33	100	
2.23	66/100 kW (90-136 HP)	33-F-000 001	33-J-299 999	04-84	12-86	3548	K	22	30	51		I	4511	K		33	94	
2.23	66/100 kW (90-136 HP)	33-H-086 637	33-J-299 999	01-87	07-88	3547	K	22	30	51		I	4048	K		33	100	
POINTER																		
1,6						3332	K	25	30	56,5		I						
1,8						3333	K	25	30	56,5		I						
POLO (M.T.)																		
0.8	25/44 kW (34-60 HP)	866 2300 001	86-E-050 306	04-75	10-83	3089	K	20	25	45,5		I	4005	K		33	91,8	
1.0	29/56 kW (40-76 HP)	86-E-050 307	80-N-500 000	11-83	07-92	3079	K	20	30	45,5		I	4005	K		33	91,8	
1.0	33/56 kW (45-76 HP)	80-P-000 001	80-R-150 000	08-92	07-94	3079	K	20	30	45,5		I	4005	K		33	91,8	
1.0	37 kW	6N-VW-030 001		07-96		3307	K	22	30	53		I	4005	K		33	91,8	
1.05	33 kW	6N-SW-000 001		10-94		3307	K	22	30	53		I	4005	K		33	91,8	
1.3	25/44 kW (34-60 HP)	866 2300 001	86-E-050 306	04-75	10-83	3089	K	20	25	45,5		I	4005	K		33	91,8	
1.3	29/56 kW (40-76 HP)	86-E-050 307	80-N-500 000	11-83	07-92	3079	K	20	30	45,5		I	4005	K		33	91,8	
1.3	33/56 kW (45-76 HP)	80-P-000 001	80-R-150 000	08-92	07-94	3079	K	20	30	45,5		I	4005	K		33	91,8	
1.3	40 kW	6N-SW-000 001	6N-TW 004 084	10-94	07-95	3307	K	22	30	53		I	4005	K		33	91,8	
1.4	44 kW	6N-TW 000 001		07-95		3307	K	22	30	53		I	4005	K		33	91,8	
1.4	74 kW	6N-SW 020 001		04-96		3307	K	22	30	53		I	4005	K		33	91,8	
1.6	55 kW	6N-SW-000 001		10-94		3307	K	22	30	53		I	4005	K		33	91,8	
POLO DIESEL (M.T.)																		
1.3 D	33 kW (45 HP)	80-H-000 001	80-L-250 000	08-86	09-90	3079	K	20	30	45,5		I	4005	K		33	91,8	
1.4 D	35 kW (48 HP)	80-M-000 001	80-R-150 000	08-86	09-90	3079	K	20	30	45,5		I	4005	K		33	91,8	
1.9 D	47 kW (64 HP)	6N-SW-000 001		10-94		3307	K	22	30	53		I	4005	K		33	91,8	
POLO G 40																		
1,3	85 kW	80-H-000 001	80-R-150 000	08-86	07-94	3079	K	20	30	45,5		I	4005	K		33	91,8	
POLO (A.T.)																		
1,4	44 kW	6N-TW-000 001		07-95		3307	K	22	30	53		I	4005	K		33	91,8	
1,6	55 kW	6N-TW-000 001		07-95		3307	K	22	30	53		I	4005	K		33	91,8	
RABBIT																		
TT & PICK UP			17-A-0360 000	01-75	12-80	3505	K	22	30	51		E	4511	K		33	94	
TT & PICK UP			17-A-0360 000	01-81	12-84	3548	K	22	30	51		I	4511	K		33	94	
SANTANA (A.T.)																		
1.6	40/66 kW (54-90 HP)	32-B-000 001		08-81	12-84	3548	K	22	30	51		I	4511	K		33	94	
1.8	40/66 kW (54-90 HP)	32-B-000 001		08-81	12-84	3548	K	22	30	51		I	4511	K		33	94	
1.9	85 kW (115 HP)	32-B-000 001	32-D-092 500	08-81	12-82	3548	K	22	30	51		I	4511	K		33	94	
1.9	85 kW (115 HP)	32-D-092 501		12-82	12-84	3547	K	22	30	51		I						
2.2	85 kW (115 HP)	32-B-000 001	32-D-092 500	08-81	12-82	3548	K	22	30	51		I	4511	K		33	94	
2.2	85 kW (115 HP)	32-D-092 501		12-82	12-84	3547	K	22	30	51		I						
4 CYL		32-B-000 001		08-81		3548	K	22	30	51		I						



	CHASSIS →	← CHASSIS		G L O N .										
				XXXX	K	A	B	C	ABS	P	XXXX	K	A	B

VOLKSWAGEN

5 CYL		32-B-000 001	32-D-092 500	08-81	12-82	3548	K	22	30	51		I					
5 CYL		32-D-092 501		12-82	12-84	3547	K	22	30	51		I					
SANTANA (M.T.)																	
1.6	40/66 kW (54-90 HP)	32-C-000 001		08-81	12-84	3548	K	22	30	51		I	4511	K		33	94
1.8	40/66 kW (54-90 HP)	32-C-000 001		08-81	12-84	3548	K	22	30	51		I	4511	K		33	94
1.9	85 kW (115 HP)	32-B-000 001	32-D-092 500	08-81	12-82	3548	K	22	30	51		I	4511	K		33	94
1.9	85 kW (115 HP)	32-D-092 501		12-82	12-84	3547	K	22	30	51		I					
2.2	85 kW (115 HP)	32-B-000 001	32-D-092 500	08-81	12-82	3548	K	22	30	51		I	4511	K		33	94
2.2	85 kW (115 HP)	32-D-092 501		12-82	12-84	3547	K	22	30	51		I					
4 CYL		32-C-000 001		08-81	12-84	3548	K	22	30	51		I	4511	K		33	94
5 CYL		32-B-000 001	32-D-092 500	08-81	12-82	3548	K	22	30	51		I					
5 CYL		32-D-092 501		12-82	12-84	3547	K	22	30	51		I					
SCIROCCO (A.T.)																	
1.5	51/62 kW (70-85 HP)	534 2000 001		02-74	08-75	3505	K	22	30	51		E	4511	K		33	94
1.6	55 kW (75 HP)	534 2000 001	53-A-0051 000	02-74	02-80	3505	K	22	30	51		E	4511	K		33	94
1.6	53/55 kW (72-75 HP)	53-E-000 001	53-N-010 000	02-80	07-92	3548	K	22	30	51		I	4511	K		33	94
1.8	66 kW (90 HP)	53-E-000 001	53-K-020 000	08-83	07-89	3548	K	22	30	51		I	4511	K		33	94
1.8	66 kW (90 HP)	53-L-000 001	53-N-010 000	08-89	07-92	3547	K	22	30	51		I	4048	K		33	100
SCIROCCO (M.T.)																	
1.1	37 kW (50 HP)	534 2000 001	53-A-051 000	02-74	02-80	3505	K	22	30	51		E	4005	K		33	91,8
1.1	37 kW (50 HP)	53-A-051 001	53-D-900 000	02-80	07-83	3548	K	22	30	51		I	4005	K		33	91,8
1.3	40 kW (55 HP)	534 2000 001	53-A-051 000	02-74	02-80	3505	K	22	30	51		E	4005	K		33	91,8
1.3	40 kW (55 HP)	53-E-000 001	53-E-060 000	02-80	07-84	3548	K	22	30	51		I	4005	K		33	91,8
1.5	51/62 kW (70-85 HP)	534 2000 001		02-74	08-75	3505	K	22	30	51		E	4511	K		33	94
1.6	55/63 kW (75-85 HP)	534 2000 001	53-A-051 000	02-74	02-80	3505	K	22	30	51		E	4511	K		33	94
1.6	51/55 kW (70-75 HP)	53-E-000 001	53-N-010 000	02-80	07-92	3548	K	22	30	51		I	4511	K		33	94
1.6 GTi, GLi	81 kW (110 HP)	53-A-0051 000		06-76	02-80	3505	K	22	30	51		E	4511	K		33	94
1.6 GTi, GLi	81 kW (110 HP)	53-A-0051 001	53-D-900 000	02-80	07-83	3548	K	22	30	51		I	4511	K		33	94
1.8	66 kW (90 HP)	53-E-000 001	53-J-001 854	08-83	08-87	3548	K	22	30	51		I	4511	K		33	94
1.8	66 kW (90 HP)	53-J-001 855	53-N-010 000	09-87	07-92	3547	K	22	30	51		I	4048	K		33	100
1.8 16V	92/102 kW (125-140 HP)	53-G-004 120	53-N-010 000	10-85	07-92	3547	K	22	30	51		I					
1.8 GTi, GLi	70/82 kW (95-112 HP)	53-E-000 001	53-E-012 217	08-83	10-83	3548	K	22	30	51		I	4511	K		33	94
1.8 GTi, GLi	70/82 kW (95-112 HP)	53-E-012 218	53-N-010 000	10-83	07-92	3547	K	22	30	51		I	4048	K		33	100
TRANSPORTER (A.T.)																	
T2 1.3-2.0			2 192 153 964	01-68	12-79	4047	K		33	100			4047	K		33	100
T2 80 1.6-2.1		24-A-0000 010	24-N-020 000	05-79	12-92	4047	K		33	100			4047	K		33	100
T4 2.5	81 kW (110 HP)	70-M-000 001	70-R-136 290	09-90	07-94	3213	K	38	33	60		I	4213	K		33	108
T4 2.5	81 kW (110 HP)	70-S-000 001		07-94		3369	K	38	27	60		I	4369	K		28	108
T4 2.5 ABS	81 kW (110 HP)	70-M-000 001	70-R-136 290	09-90	07-94	3347	K	38	33	60	48	I	4213	K		33	108
T4 2.5 ABS	81 kW (110 HP)	70-S-000 001	70-R-136 290	07-94		3370	K	38	27	60	48	I	4369	K		28	108
TRANSPORTER (M.T.)																	
T2 1.3-2.0			2 192 153 964	01-68	12-79	4047	K		33	100			4047	K		33	100
T2 80 1.6-2.1		24-A-0000 001	24-N-015 000	05-79	12-92	4047	K		33	100			4047	K		33	100
T4 1.8	49 kW (67 HP)	70-M-000 001	70-N-200 000	12-90	07-92	3213	K	38	33	60		I	4213	K		33	108
T4 1.8 ABS	49 kW (67 HP)	70-M-020 359	70-N-200 000	12-90	07-92	3347	K	38	33	60	48	I	4213	K		33	108
T4 2.0	62 kW (85 HP)	70-M-000 001	70-R-136 290	09-90	07-94	3213	K	38	33	60		I	4213	K		33	108



CHASSIS ↑

→ CHASSIS



G L O N .

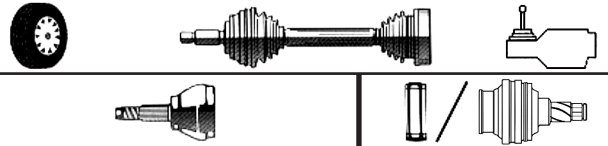





XXXX	K	A	B	C	ABS	P	XXXX	K	A	B	C
------	---	---	---	---	-----	---	------	---	---	---	---

VOLKSWAGEN

T4 2.0	62 kW (85 HP)	70-S-000 001		07-94		3369	K	38	27	60		I					
T4 2.0 ABS	62 kW (85 HP)	70-M-000 001	70-R-136 290	09-90	07-94	3347	K	38	33	60	48	I	4213	K		33	108
T4 2.0 ABS	62 kW (85 HP)	70-S-000 001		07-94		3370	K	38	27	60	48	I					
T4 2.5	81 kW (111 HP)	70-M-000 001	70-R-136 290	09-90	07-94	3213	K	38	33	60		I	4213	K		33	108
T4 2.5	81 kW (111 HP)	70-S-000 001		07-94		3369	K	38	27	60		I	4369	K		28	108
T4 2.5 ABS	81 kW (111 HP)	70-M-000 001	70-R-136 290	09-90	07-94	3347	K	38	33	60	48	I	4213	K		33	108
T4 2.5 ABS	81 kW (111 HP)	70-S-000 001		07-94		3370	K	38	27	60	48	I	4369	K		28	108
TRANSPORTER DIESEL (A.T.)																	
T4 2.4 D	57 kW (78 HP)	70-M-000 001	70-R-136 290	09-90	07-94	3213	K	38	33	60		I	4213	K		33	108
T4 2.4 D	57 kW (78 HP)	70-S-000 001		07-94		3369	K	38	27	60		I	4369	K		28	108
T4 2.4 D ABS	57 kW (78 HP)	70-M-000 001	70-R-136 290	09-90	07-94	3347	K	38	33	60	48	I	4213	K		33	108
T4 2.4 D ABS	57 kW (78 HP)	70-S-000 001		07-94		3370	K	38	27	60	48	I	4369	K		28	108
T4 2.5 TURBO DIESEL	75 kW	70-S-061 220		01-95		3369	K	38	27	60		I					
T4 2.5 TURBO DIESEL ABS	75 kW	70-S-061 220		01-95		3370	K	38	27	60	48	I					
T4 2.5 TDi	75 kW (102 HP)	70-S-061 220		01-95		3369	K	38	27	60		I	4369	K		28	108
T4 2.5 TDi ABS	75 kW (102 HP)	70-S-061 220		01-95		3370	K	38	27	60	48	I	4369	K		28	108
TRANSPORTER DIESEL (M.T.)																	
T2 80 D 1.6-1.7		24-B-079 862	24-C-200 000	01-81	08-82	4047	K		33	100			4047	K		33	100
T2 80 D 1.6-1.7		24-D-000 001		08-82	07-92	4047	K		33	100			4047	K		33	100
T2 80 TURBO DIESEL 1.6-1.7		24-G-000 001	24-N-020 000	08-85	07-92	4047	K		33	100			4047	K		33	100
T4 1.9 TURBO DIESEL	50 kW (68 HP)	70-P-032 051	70-R-136 290	10-92	07-94	3213	K	38	33	60		I	4213	K		33	108
T4 1.9 TURBO DIESEL	50 kW (68 HP)	70-S-000 001		07-94		3369	K	38	27	60		I					
T4 1.9 D	44 kW (60 HP)	70-M-000 001	70-R-136 290	09-90	07-94	3213	K	38	33	60		I	4213	K		33	108
T4 1.9 D	44 kW (60 HP)	70-S-000 001	70-S-061 219	07-94	12-94	3369	K	38	27	60		I					
T4 1.9 D ABS	44 kW (60 HP)	70-M-000 001	70-R-136 290	09-90	07-94	3347	K	38	33	60	48	I	4213	K		33	108
T4 1.9 D ABS	44 kW (60 HP)	70-S-000 001	70-S-061 219	07-94	12-94	3370	K	38	27	60	48	I					
T4 1.9 TURBO DIESEL ABS	50 kW (68 HP)	70-P-032 051	70-R-136 290	10-92	07-94	3347	K	38	33	60	48	I	4213	K		33	108
T4 1.9 TURBO DIESEL ABS	50 kW (68 HP)	70-S-000 001		07-94		3370	K	38	27	60	48	I					
T4 2.4 D	57 kW (78 HP)	70-M-000 001	70-R-136 290	09-90	07-94	3213	K	38	33	60		I	4213	K		33	108
T4 2.4 D	57 kW (78 HP)	70-S-000 001		07-94		3369	K	38	27	60		I	4369	K		28	108
T4 2.4 D ABS	57 kW (78 HP)	70-M-000 001	70-R-136 290	09-90	07-94	3347	K	38	33	60	48	I	4213	K		33	108
T4 2.4 D ABS	57 kW (78 HP)	70-S-000 001		07-94		3370	K	38	27	60	48	I	4369	K		28	108
T4 2.5 TURBO DIESEL	75 kW	70-S-061 220	70-S-200 000	01-95	07-95	3369	K	38	27	60		I					
T4 2.5 TURBO DIESEL	75 kW	70-T-000 001		07-95		3369	K	38	27	60		I					
T4 2.5 TURBO DIESEL ABS	75 kW	70-S-061 220	70-S-200 000	01-95	07-95	3370	K	38	27	60	48	I					
T4 2.5 TURBO DIESEL ABS	75 kW	70-T-000 001		07-95		3370	K	38	27	60	48	I					
T4 2.5 TDi	75 kW (102 HP)	70-S-061 220		01-95		3369	K	38	27	60		I	4369	K		28	108
T4 2.5 TDi ABS	75 kW (102 HP)	70-S-061 220		01-95		3370	K	38	27	60	48	I	4369	K		28	108
TRANSPORTER SYNCRO RWD (M.T.)																	
"SYNCRO 14"		24-F-000 001		10-84	07-92	4047	K		33	100			4047	K		33	100
"SYNCRO 16"		24-F-000 001		10-84	07-92	4051	K		28	108			4051	K		28	108
TRANSPORTER																	
T4 1.9 DIESEL	44 kW (60 HP)	70-S-000 001	70-S-061 219	07-94	12-94	3369	K	38	27	60		I	4369	K		28	108
T4 1.9 DIESEL ABS	44 kW (60 HP)	70-S-000 001	70-S-061 219	07-94	12-94	3370	K	38	27	60	48	I	4369	K		28	108
T4 1.9 TURBO DIESEL	50 kW (68 HP)	70-S-000 001		07-94		3369	K	38	27	60		I	4369	K		28	108
T4 1.9 TURBO DIESEL ABS	50 kW (68 HP)	70-S-000 001		07-94		3370	K	38	27	60	48	I	4369	K		28	108



	CHASSIS →	→ CHASSIS		G L O N .														
																		
				XXXX	K	A	B	C	ABS	P	XXXX	K	A	B	C			

VOLKSWAGEN

Model	Power (kW/HP)	Chassis Code	Year	Year	Year	XXXX	K	A	B	C	ABS	P	XXXX	K	A	B	C
T4 2.0	62 kW (84 HP)	70-S-000 001	07-94			3369	K	38	27	60		I	4369	K		28	108
T4 2.0 ABS	62 kW (84 HP)	70-S-000 001	07-94			3370	K	38	27	60	48	I	4369	K		28	108
VENTO (A.T.)																	
1.6	74 kW (101 HP)	1H-S-000 001	07-94			3547	K	22	30	51		I					
1.8	66 kW (90 HP)	1H-N-000 001	11-91	07-94	1H-R-990 000	3547	K	22	30	51		I	4048	K		33	100
1.8	55/66 kW (75-90 HP)	1H-S-000 001	07-94			3547	K	22	30	51		I					
2.0	85 kW (116 HP)	1H-N-105 002	01-92	07-94	1H-R-990 000	3547	K	22	30	51		I	4048	K		33	100
2.0	79/85 kW (108-116 HP)	1H-S-000 001	07-94			3547	K	22	30	51		I					
VENTO (M.T.)																	
1.4	44 kW (60 HP)	1H-N-000 001	11-91		1H-N-990 000	3548	K	22	30	51		I	4005	K		33	91,8
1.6	55 kW (75 HP)	1H-P-114 031	09-92	09-94	1H-S-180 000	3548	K	22	30	51		I	4005	K		33	91,8
1.6	55/74 kW (75-101 HP)	1H-P-114 031	10-94		1H-S-180 000	3548	K	22	30	51		I	4511	K		33	94
1.8	55 kW (75 HP)	1H-N-000 001	11-91			3547	K	22	30	51		I	4048	K		33	100
1.8	66 kW (90 HP)	1H-N-000 001	11-91			3547	K	22	30	51		I	4048	K		33	100
2.0	85kW (116 HP)	1H-N-105 002	01-92	07-94	1H-R-990 000	3340	K	36	30	53		I	4048	K		33	100
2.0 16V	110kW (150 HP)	1H-P-000 001	08-92	07-94	1H-R-990 000	3340	K	36	30	53		I					
2.8 VR6	128 kW (175 HP)	1H-N-105 002	01-92			3340	K	36	30	53		I					
VENTO DIESEL (A.T.)																	
1.9 TURBO DIESEL	55 kW (75 HP)	1H-N-000 001	11-91			3547	K	22	30	51		I	4048	K		33	100
VENTO DIESEL (M.T.)																	
1.9 D	48 kW (65 HP)	1H-N-000 001	11-91			3548	K	22	30	51		I	4511	K		33	94
1.9 TURBO DIESEL	55 kW (75 HP)	1H-N-000 001	11-91			3547	K	22	30	51		I	4048	K		33	100
1.9 TURBO DIESEL	66 kW (90 HP)	1H-R-080 001	09-93			3547	K	22	30	51		I					

VOLVO

Model	Power (kW/HP)	Chassis Code	Year	Year	Year	XXXX	K	A	B	C	ABS	P	XXXX	K	A	B	C
360 (M.T.)																	
2.0	66/85 kW (90-115 HP)		08-82	08-90		4053	K		24	94			4053	K		24	94
440																	
1.7			01-88			3404	K	22	22	50		E					
1.7 ABS			01-88			3405	K	22	22	50	44	E					
480																	
1.7			01-86			3404	K	22	22	50		E					
1.7 ABS			01-86			3405	K	22	22	50	44	E					
850																	
2.4 ABS	103/125 kW (140-170 HP)		06-91			3277	K	26	25	56,5	48	E					



CHASSIS ↑

→ CHASSIS

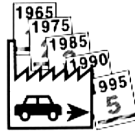

G L O N .

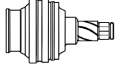
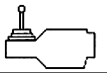

XXXX	K	A	B	C	ABS	P	XXXX	K	A	B	C
------	---	---	---	---	-----	---	------	---	---	---	---

ZASTAVA

YUGO																	
55 1.1	40 kW (55 HP)	04-85		3501	K	20	20	43,1		E							
55 1.3	48 kW (65 HP)	04-85		3501	K	20	20	43,1		E							
GV 55		01-86	12-88	3501	K	20	20	43,1		E							
101																	
TT				3504	K	22	20	48		E							
1100																	
TT		01-74	12-91	3501	K	20	20	43,1		E							



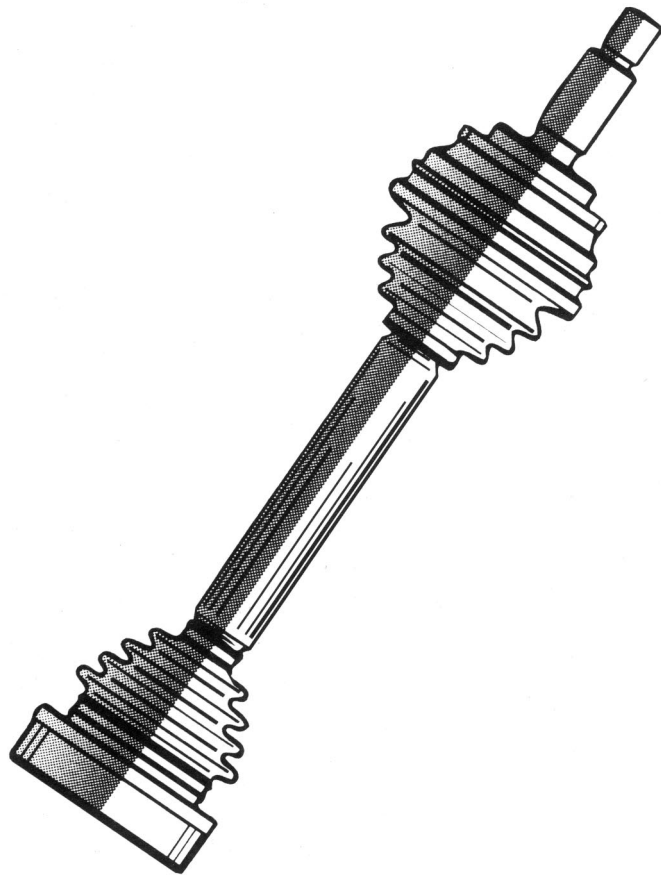

ZAZ

TAVRIA																	
1,1	37/39 kW (50-53 HP)	04-87		3320	K	22	22	42		I							







	CHASSIS →	→ CHASSIS		G L O N .									
				 SX					 DX				
				XXXX	A	B	D	L	XXXX	A	B	D	L

AUDI

80 I (M.T.)														
1,3	40/44 kW (54-60 HP)		05-72	07-76	7009	22	33	32	600	7009	22	33	32	600
1,5	55 kW (75 HP)		05-72	08-75	7009	22	33	32	600	7009	22	33	32	600
1,5	63 kW (85 HP)		05-72	07-76	7009	22	33	32	600	7009	22	33	32	600
1,6	55/63 kW (75-85 HP)		09-75	07-76	7009	22	33	32	600	7009	22	33	32	600
1.6 GT	74 kW (100 HP)		09-73	07-76	7009	22	33	32	600	7009	22	33	32	600
1.6 GTE	81 kW (110 HP)		01-76	07-76	7009	22	33	32	600	7009	22	33	32	600
80 II (M.T.)														
1,3	40 kW (54 HP)		08-76	07-78	7009	22	33	32	600	7009	22	33	32	600
1,6	55/63 kW (75-85 HP)		08-76	07-78	7009	22	33	32	600	7009	22	33	32	600
1.6 GTE	81 kW (110 HP)		08-76	07-78	7009	22	33	32	600	7009	22	33	32	600

MOSKVICH

ALEKO														
2141					7226	25	25	26	645	7226	25	25	26	645
ASLK 2140														
ASLK 2140	55 kW (75 HP)		03-76		7226	25	25	26	645	7226	25	25	26	645
2140														
2140	55 kW (75 HP)		07-78	11-83	7226	25	25	26	645	7226	25	25	26	645

VOLKSWAGEN

CADDY (M.T.)															
1,5	51 kW (70 HP)		08-82	07-83	7003	22	33	24.3	538	7004	22	33	32	750	
1,6	55 kW (75 HP)		08-83	07-92	7003	22	33	24.3	538	7004	22	33	32	750	
1.6 D	40 kW (54 HP)		08-82	07-92	7003	22	33	24.3	538	7004	22	33	32	750	
1,8	70 kW (95 HP)		10-82	07-92	7003	22	33	24.3	538	7004	22	33	32	750	
GOLF (A.T.)															
1,5	48/51 kW (65-70 HP)	175 3000 001	17-D-641 909	04-74	07-83	7003	22	33	24.3	538	7004	22	33	32	750



CHASSIS →

→ CHASSIS



G L O N .



SX







DX

XXXX	A	B	D	L	XXXX	A	B	D	L
------	---	---	---	---	------	---	---	---	---

VOLKSWAGEN

1,6	51/55 kW (70-75 HP)	175 3000 001	17-D-641 909	04-74	07-83	7003	22	33	24.3	538	7004	22	33	32	750
1,6	51/55 kW (70-75 HP)	17-D-641 910	1G-N-158 228	08-83	10-91	7007	22	33	24.3	538	7010	22	33	42	733
1,8	62/66 kW (84-90 HP)	17-D-641 910	1G-N-158 228	08-83	10-91	7007	22	33	24.3	538	7010	22	33	42	733
GOLF (M.T.)															
1.05	33 kW (45 HP)	17-D-641 910	1G-N-158 228	08-83	10-91	7005	22	33	24.3	560	7010	22	33	42	733
1.1	37 kW (50 HP)	175 3000 001	17-D-641 909	04-74	07-83	7001	22	33	24.3	560	7002	22	33	32	750
1.3	44 kW (60 HP)	175 3000 001	17-D-641 909	04-74	07-83	7001	22	33	24.3	560	7002	22	33	32	750
1.3	37/44 kW (50-60 HP)	17-D-641 910	1G-N-300 000	08-83	07-92	7005	22	33	24.3	560	7010	22	33	42	733
1.3 i	40 kW (55 HP)	19-H-606 005	1G-N-300 000	02-87	07-92	7005	22	33	24.3	560					
1.5	48/51 kW (65-70 HP)	175 3000 001	17-D-641 909	04-74	07-83	7003	22	33	24.3	538	7004	22	33	32	750
1.5 D	37 kW (50 HP)	175 3000 001	17-D-641 909	08-76	07-83	7003	22	33	24.3	538	7004	22	33	32	750
1.6	51/55 kW (70-75 HP)	175 3000 001	17-D-641 909	04-74	07-83	7003	22	33	24.3	538	7004	22	33	32	750
1.6	51/55 kW (70-75 HP)	17-D-641 910	1G-N-300 000	08-83	07-92	7007	22	33	24.3	538	7010	22	33	42	733
1.6 D	40 kW (54 HP)	17-A-0116 213	17-D-641 909	10-79	07-83	7003	22	33	24.3	538	7004	22	33	32	750
1.6 D	40 kW (54 HP)	17-D-641 910	1G-N-158 228	08-83	10-91	7007	22	33	24.3	538	7010	22	33	42	733
1.6 GTi	81 kW (110 HP)	176 3379 207	17-C-999 999	06-76	07-92	7003	22	33	24.3	538	7006	22	33	32	750
1.6 TURBO DIESEL	51 kW (70 HP)	17-D-641 910	1G-N-158 228	28-83	10-91	7007	22	33	24.3	538	7010	22	33	42	733
1.8	62/66 kW (84-90 HP)	19-E-431 737	1G-N-158 228	01-84	10-91	7007	22	33	24.3	538	7010	22	33	42	733
1.8 GTi	82 kW (112 HP)	17-D-000 001	17-D-641 909	08-82	07-83	7003	22	33	24.3	538	7006	22	33	32	750
GOLF CABRIO (A.T.)															
1,5	48/51 kW (65-70 HP)	175 3000 001	17-D-641 909	04-74	07-83	7003	22	33	24.3	538	7004	22	33	32	750
1,6	51/55 kW (70-75 HP)	175 3000 001	17-D-641 909	04-74	07-83	7003	22	33	24.3	538	7004	22	33	32	750
1,6	51/55 kW (70-75 HP)	17-D-641 910	1G-N-300 000	08-83	07-92	7007	22	33	24.3	538	7010	22	33	42	733
1.6 GTi	81 kW (110 HP)	176 3379 207	17-C-999 999	06-76	07-92	7003	22	33	24.3	538	7006	22	33	32	750
1,8	62/66 kW (84-90 HP)	19-E-431 737	1G-N-158 228	01-84	10-91	7007	22	33	24.3	538	7010	22	33	42	733
1.8 GTi	82 kW (112 HP)	17-D-000 001	17-D-641 909	08-82	07-83	7003	22	33	24.3	538	7006	22	33	32	750
GOLF CABRIO (M.T.)															
1,3	44 kW (60 HP)	159 2800 001	15-E-006 506	02-79	09-83	7001	22	33	24.3	560	7002	22	33	32	750
1,3	44 kW (60 HP)	15-E-006 507	15-G-035 000	10-83	07-86	7005	22	33	24.3	560	7010	22	33	42	733
1,5	51 kW (70 HP)	159 2800 001	15-D-050 0000	02-79	07-83	7003	22	33	24.3	538	7004	22	33	32	750
1,6	51/55 kW (70-75 HP)	159 2800 001	15-E-006 506	02-79	09-83	7003	22	33	24.3	538	7004	22	33	32	750
1,6	53/55 kW (72-75 HP)	15-E-006 507	15-J-001 799	10-83	08-87	7007	22	33	24.3	538	7008	22	33	32	750
1.6 GLi	81 kW (110 HP)	159 2800 001	15-E-006 506	02-79	09-83	7003	22	33	24.3	538	7006	22	33	32	750
1,8	66/70 kW (90-95 HP)	15-E-000 001	15-J-001 799	08-83	08-87	7007	22	33	24.3	538					
1.8 GLi	82 kW (112 HP)	15-E-000 001	15-E-035 000	08-83	07-84	7003	22	33	24.3	538	7006	22	33	32	750
GOLF SYNCRO FWD (M.T.)															
1,8	62/72 kW (84-98 HP)	19-G-000 001	1G-K-990 000	08-85	07-89	7009	22	33	32	600					
PASSAT (M.T.)															
1,3	40/44 kW (54-60 HP)	324 2000 001	32-A-206 720	05-73	11-80	7009	22	33	32	600	7009	22	33	32	600
1,5	48/63 kW (65-85 HP)	324 2000 001	326 2087 472	05-73	12-75	7009	22	33	32	600	7009	22	33	32	600
1,6	51/63 kW (70-85 HP)	324 2000 001	32-A-206 720	05-73	11-80	7009	22	33	32	600	7009	22	33	32	600
SCIROCCO (A.T.)															
1,5	51/62 kW (70-85 HP)	534 2000 001		02-74	08-75	7003	22	33	24.3	538	7004	22	33	32	750
1,6	55 kW (75 HP)	534 2000 001	53-E-012 217	02-74	10-83	7003	22	33	24.3	538	7004	22	33	32	750
1,6	53/55 kW (72-75 HP)	53-E-012 218	53-N-010 000	10-83	07-92	7007	22	33	24.3	538					
1,8	66 kW (90 HP)	53-E-000 001	53-E-012 217	08-83	10-83	7003	22	33	24.3	538	7004	22	33	32	750



	CHASSIS →	→ CHASSIS		G L O N .									
				 SX					 DX				
				XXXX	A	B	D	L	XXXX	A	B	D	L

VOLKSWAGEN

1,8	66 kW (90 HP)	53-E-012 218	53-K-020 000	10-83	07-89	7007	22	33	24.3	538				
SCIROCCO (M.T.)														
1,1	37 kW (50 HP)	534 2000 001	53-D-900 000	02-74	07-83	7001	22	33	24.3	560	7002	22	33	32 750
1,3	40 kW (55 HP)	534 2000 001	53-E-012 217	02-74	10-83	7001	22	33	24.3	560	7002	22	33	32 750
1,3	40 kW (55 HP)	53-E-012 218	53-E-060 000	10-83	07-84	7005	22	33	24.3	560				
1,5	51/62 kW (70-85 HP)	534 2000 001		02-74	08-75	7003	22	33	24.3	538	7004	22	33	32 750
1,6	55/63 kW (75-85 HP)	534 2000 001	53-A-051 000	02-74	02-80	7003	22	33	24.3	538	7004	22	33	32 750
1,6	81 kW (110 HP)		53-D-900 000	06-75	07-83	7003	22	33	24.3	538	7004	22	33	32 750
1,6	51/55 kW (70-75 HP)	53-E-000 001	53-E-012 217	02-80	10-83	7003	22	33	24.3	538	7004	22	33	32 750
1,6	51/55 kW (70-75 HP)	53-E-012 218	53-N-010 000	10-83	07-92	7007	22	33	24.3	538	7008	22	33	32 750
1,8	66 kW (90 HP)	53-E-000 001	53-J-001 854	08-83	08-87	7007	22	33	24.3	538	7008	22	33	32 750
1,8	70/82 kW (95-112 HP)	53-E-000 001	53-E-012 217	08-83	10-83	7003	22	33	24.3	538	7004	22	33	32 750
TRANSPORTER III (M.T.)														
1,6	37 kW (50 HP)			05-79	12-82	7013	33	33	27	543	7013	33	33	27 543
1,6 D	37 kW (50 HP)		>24-C-200000	01-81	07-87	7013	33	33	27	543	7013	33	33	27 543
1,6 D	37 kW (50 HP)	24-D-000001>		01-81	07-87	7015	33	33	27	537	7015	33	33	27 537
1,6 TD	51 kW (70 HP)			08-84	07-92	7015	33	33	27	537	7015	33	33	27 537
1,6 TD SYNCRO	51 kW (70 HP)	rim =14"+diff.lock	(rear)	03-86	07-92	7015	33	33	27	537	7015	33	33	27 537
1,7 D	42 kW (55 HP)			10-86	07-92	7015	33	33	27	537	7015	33	33	27 537
1,9	44/57 kW (60-80 HP)			08-82	07-92	7015	33	33	27	537	7015	33	33	27 537
1,9	61 kW (83 HP)			01-83	07-85	7015	33	33	27	537	7015	33	33	27 537
1,9	66 kW (90 HP)			08-83	07-85	7015	33	33	27	537	7015	33	33	27 537
1,9 SYNCRO	57 kW (80 HP)	rim =14"+diff.lock	(rear)	11-84	07-92	7015	33	33	27	537	7015	33	33	27 537
2,0	51 kW (70 HP)			05-79	04-86	7013	33	33	27	543	7013	33	33	27 543
2,1	68 kW (95 HP)			07-89	07-92	7015	33	33	27	537	7015	33	33	27 537
2,1	70/82 kW (95-112 HP)			08-85	07-92	7015	33	33	27	537	7015	33	33	27 537
2,1 SYNCRO	70/82 kW (95-112 HP)			08-85	07-92	7015	33	33	27	537	7015	33	33	27 537

CONDIZIONI GENERALI

I prodotti **GLO** sono fabbricati in conformità ad un elevatissimo standard qualitativo e concepiti per una perfetta intercambiabilità con gli originali.

Ogni eventuale riferimento diverso dal numero di codice **GLO** è riportato al solo scopo di agevolare l'identificazione e la corretta applicazione dei nostri prodotti.

La **GLO** garantisce tutti i propri prodotti da difetti di materiale e/o di fabbricazione. Ogni prodotto che venisse eventualmente riconosciuto difettoso dopo il controllo tecnico da parte della **GLO**, sarà sostituito in garanzia senza alcun addebito.

La garanzia viene riconosciuta se il prodotto ritorna in **GLO** completo di tutti i componenti (compreso il grasso residuo) e relativi accessori (fascette, cuffia, ecc.) e nello stato in cui si è verificato il problema (non deve essere pulito).

Il Cliente che vuole rendere prodotti da noi fabbricati deve chiedere autorizzazione preventiva a **GLO** tramite il modulo M039.

I prodotti **GLO** sono confezionati singolarmente in una propria scatola. Il pacco standard contiene 6 pezzi. I quantitativi ordinati dovranno essere multipli di 6.

Si prega di interpellare lo stabilimento per ogni ulteriore informazione.

ALLGEMEINE HINWEISE

GLO-Produkte werden nach dem höchsten Qualitätsstandard hergestellt und sind vollkommen austauschbar mit Originalteilen. Die ausser den **GLO**-Referenzen angegebenen Nummern dienen nur zur Identifizierung.

GLO garantiert die einwandfreie Qualität jedes Produktes und wird jedes Teil, das sich berechtigterweise als fehlerhaft herausgestellt hat, sofort nach Rücksendung ins Werk kostenlos ersetzen. Die Garantie wird nur für Teile gewährleistet, die komplett in allen ihren Teilen (mit Residual-Fett, Manschette, Klammern und sonstigem Zubehör), ungesäubert sowie gemäss der von **GLO** herausgegebenen Rückgabe-Prozedur an **GLO** zurückgeschickt werden.

Bitte verschicken Sie die beanstandete Ware nur nachdem Sie das Formular M039 sachgemäss ausgefüllt, an **GLO** gefaxt haben und von **GLO** die entsprechende Rückschick-Erlaubnis mit Verfahrensnummer erhalten haben.

GLO-Produkte sind in Einzelkartons und Umkartons zu jeweils 6 Stück verpackt.

Aufträge sollten in einer Mindest-Stückzahl von 6 bzw dem Mehrfachen von 6 erteilt werden.

Bitte kontaktieren Sie **GLO** fuer weitere Nachrichten.

CONDICIONES GENERALES

Los productos **GLO**, son manufacturados siguiendo los mas altos niveles de calidad, siendo intercambiables en todos los casos con las partes originales.

Numeros de otros fabricantes, son indicados solamente para efectos de identificación.

GLO garantiza que todos sus productos se encuentran libres de defectos de fabricacion y reemplazara sin cargo cualquier pieza encontrada defectuosa con la unica condicion de enviarla a la fabrica.

La garantia es valida solo, si los productos son devueltos con todos sus componentes (incluso la grasa residual) y todos los complementos (presillas, botas etc.).

Antes de restituir el producto, el cliente debe llenar la forma M039 y enviarla a **GLO** para su autorización.

Los productos **GLO** estan envasados en cajas individuales, empacados en cartonones de seis (cada uno).

Las ordenes deberan ser en multiple de seis piezas.

Para cualquier informacion adicional, favor hacer contacto con la fabrica.

GENERAL CONDITIONS

GLO products are manufactured to the highest quality standards and are interchangeable in every way with original parts.

Other than **GLO** numbers are shown for identification only.

GLO warrants all products to be free from defect and will replace at no charge any piece found defective upon its return to the factory.

The warranty is valid only if the goods are returned to **GLO** complete of all the components including residue of the grease and with all the corresponding accessories (clamps, boot, etc.).

Before returning goods, the client should first fill in the form M039 and send it to **GLO** for authorization.

GLO products are packaged in a single box with standard multiple package of 6 each.

Orders should be in multiple of 6.

Please contact the factory for any further information.

CONDITIONS GENERALES

Les produits **GLO** sont produits avec des standards de qualité élevés et sont parfaitement interchangeables avec les pièces d'origine.

Des références autres que celles de **GLO** sont fournies afin de faciliter l'identification de nos produits.

GLO garantit tous ses produits contre les défauts de matière et de fabrication. Toute pièce reconnue défectueuse après un contrôle technique de la part de **GLO** sera remplacée gratuitement.

La garantie sera appliquée si le joint est retourné avec tous ses composants et accessoires y compris la graisse, les colliers, le soufflet etc. et en l'état dans lequel ils ont été retiré du véhicule (Ils ne doivent pas être lavé).

Le client qui désire retourner des produits fabriqué par notre Société doit demander l'autorisation préalable à **GLO** utilisant le formulaire M039.

Les produits **GLO** sont emballés séparément dans une boîte et livrés dans des cartons de 6 pièces.

Les commandes devront donc être des multiples de 6.

Veillez nous contacter pour toute information ultérieure.

ОСНОВНЫЕ УСЛОВИЯ

Продукция ГЛО изготовлена в соответствии с высочайшими требованиями качества и абсолютно взаимозаменяема с оригинальной продукцией.

Таблица соответствия между оригинальным кодом продукции и кодом ГЛО предложена в целях информации.

Вся продукция ГЛО имеет гарантию в случае дефектов материала или изготовления. Каждый дефективный продукт будет подвержен техническому контролю со стороны ГЛО и будет заменён по гарантии.

Гарантия на продукцию, которая возвращена на фирму ГЛО, признается только в случае наличия всех составных частей шарнира (включая оставшуюся смазку) и комплектующих изделий (хомуты, гофрированный колпак и т.д.). Если клиент желает осуществить возврат нашей продукции, должен заранее сделать запрос на фирму ГЛО, пользуясь формуляром M039.

Каждый продукт ГЛО упакован в отдельную коробку, стандартный пакет содержит 6 штук. Заказанное количество должно быть кратно 6.

За получением наибольшей информации просим обращаться на предприятие.



GLO S.p.A., A Metaldyne Company

Via Pinzone, 2 - 46025 Poggio Rusco MN - Italy
Telephone +39/0386/522211 - Telefax +39/0386/522212
E-mail: glo@glo.it - Web site: <http://www.glo.it>

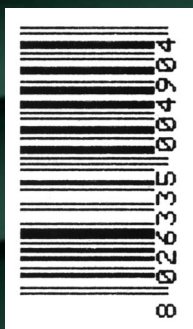

Central and South America Branch:
Telephone +1/305/406 1152 - Telefax +1/305/406 2056
E-mail: Miami_Branch@glo.it